



# MONSTER FIGHTERS

10228







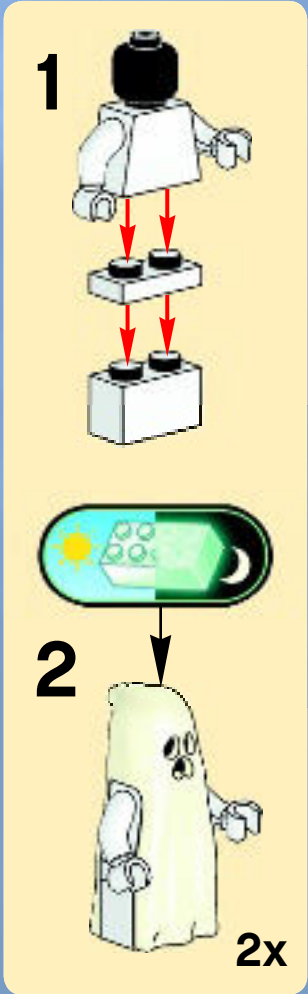
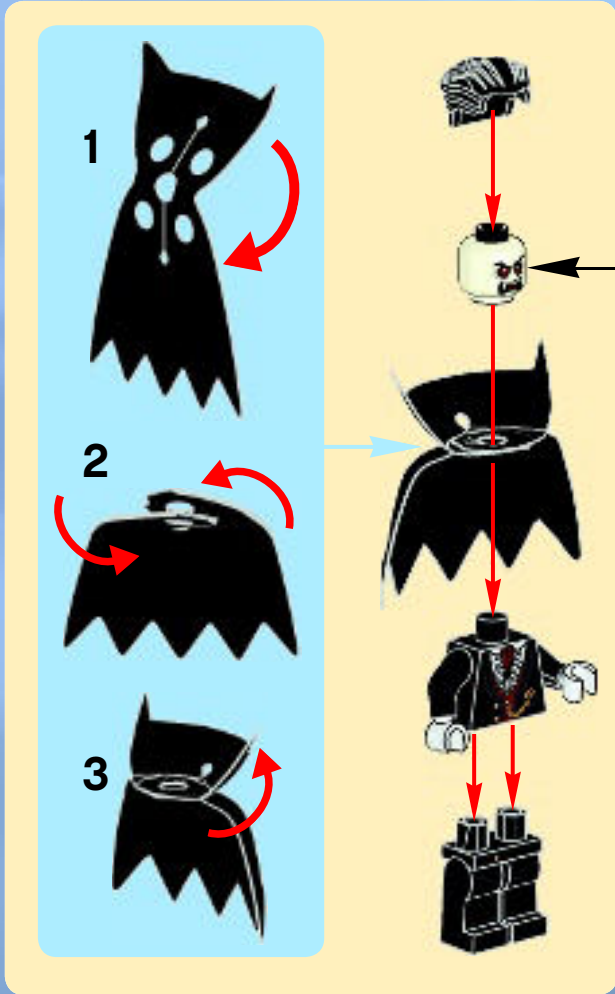
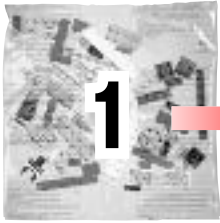

<http://lego.com/brickseparator>

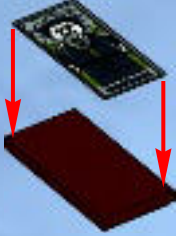
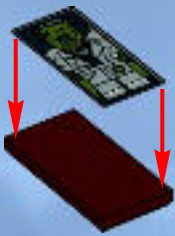
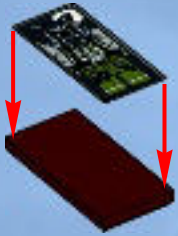
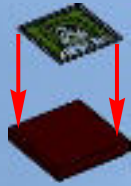
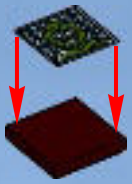

1x



1x



1x

# 2

## 1



## 2



2x



2x



2x

# 3

## 1



## 2



# 2x



1x



1x



2x

# 1



1x



1x



1x

# 4

## 1



## 2





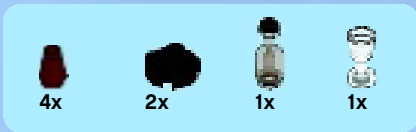

# 5

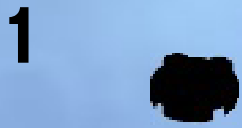

# 6

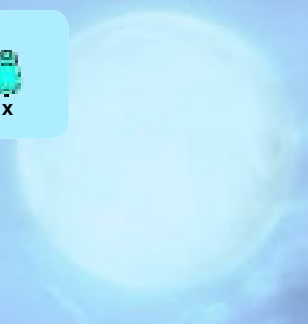



# 7

1



2



3



4



# 8

1

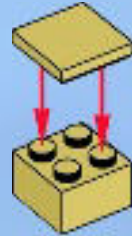

2

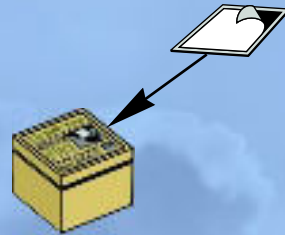

3

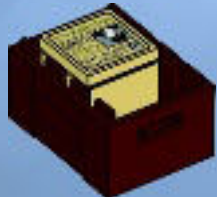

4







# 9

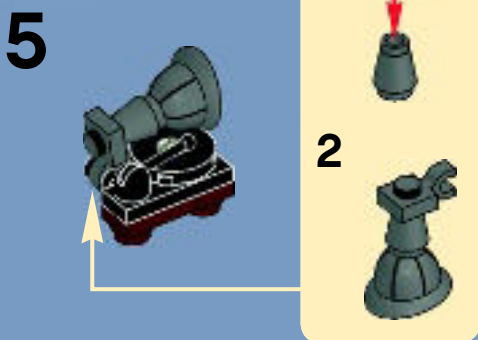
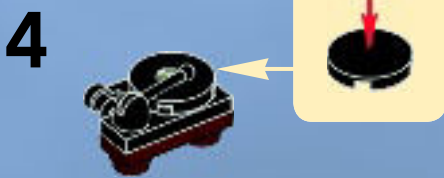

# 10

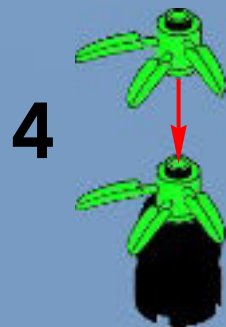



1x



1x

# 11

1

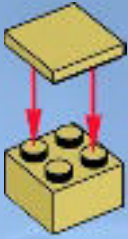

2

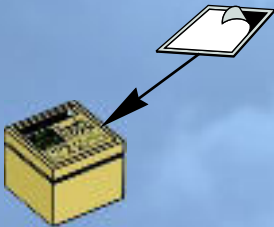

1x



1x



1x

# 12

1



2



2x



1x

# 13

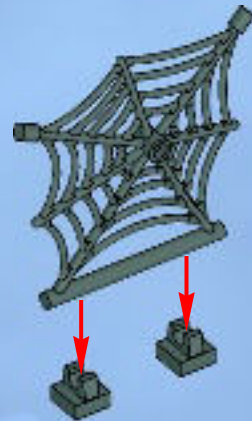

1x



1x



1x

# 14

1

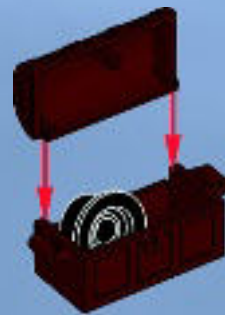

2





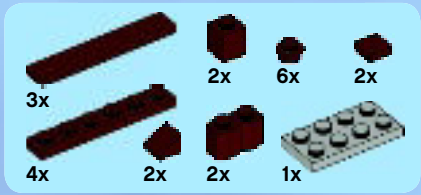

15

1



2



3

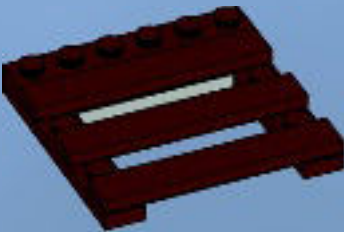

4

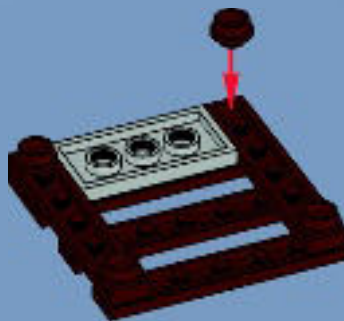

5

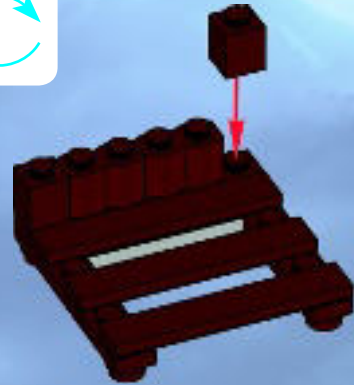

6



7



8



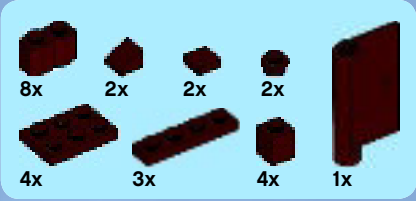

# 16

1



2

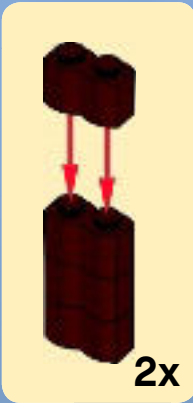

3

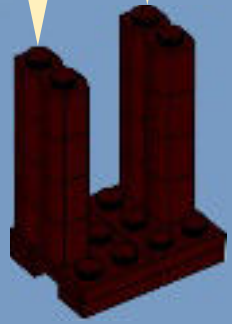

4

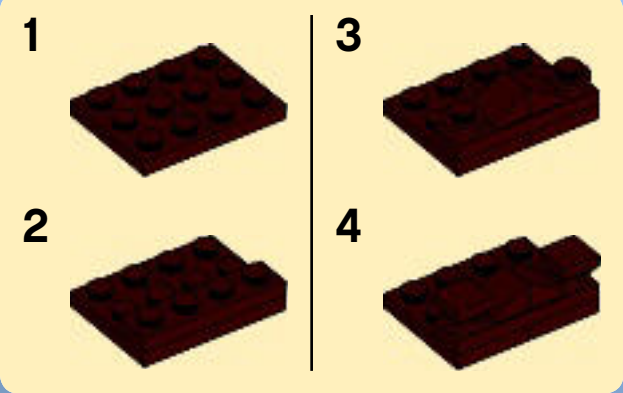

5







1x



1x



2x



2x



1x



1x



1x



3x



2x



2x



1x



1x

# 17

1

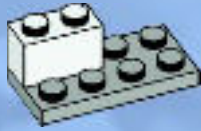

2

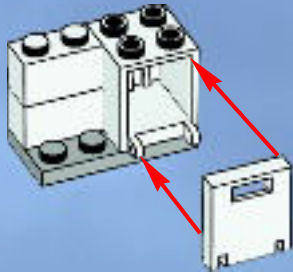

3

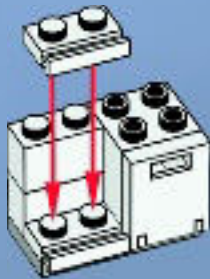

4



5



6



7



8



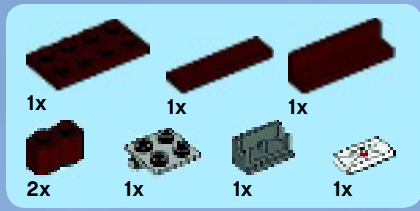

# 18

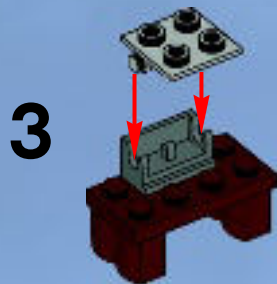

# 19





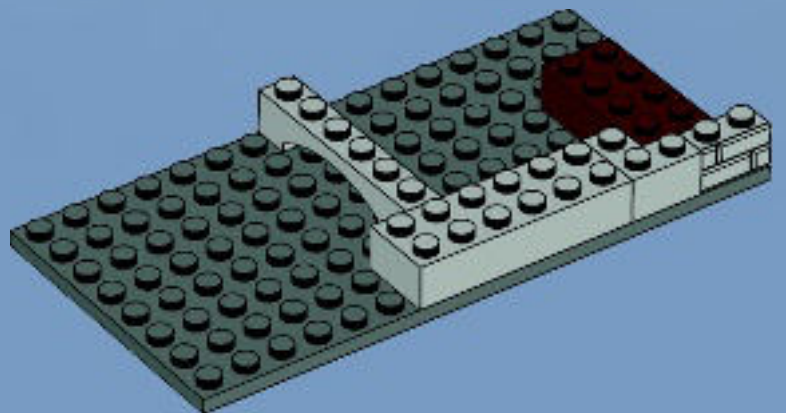
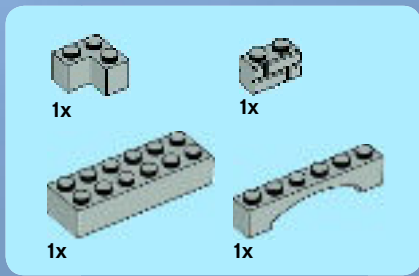
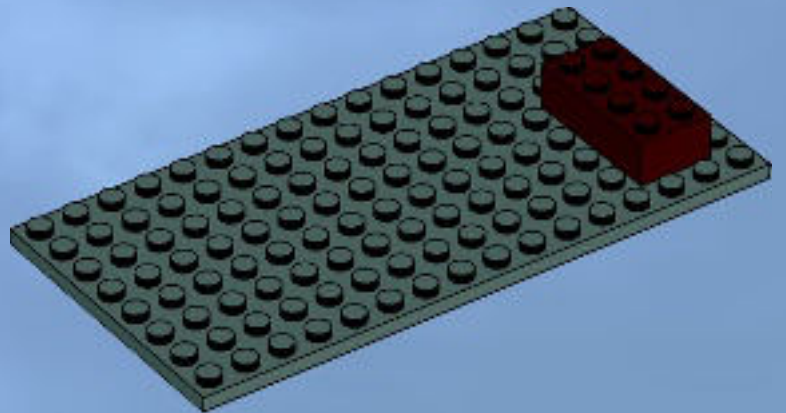
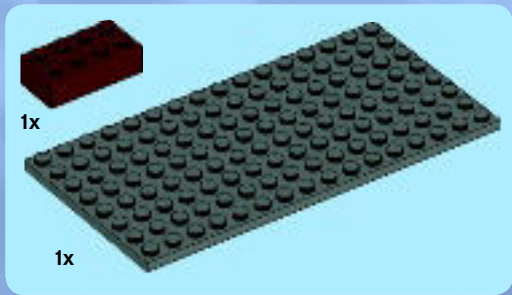
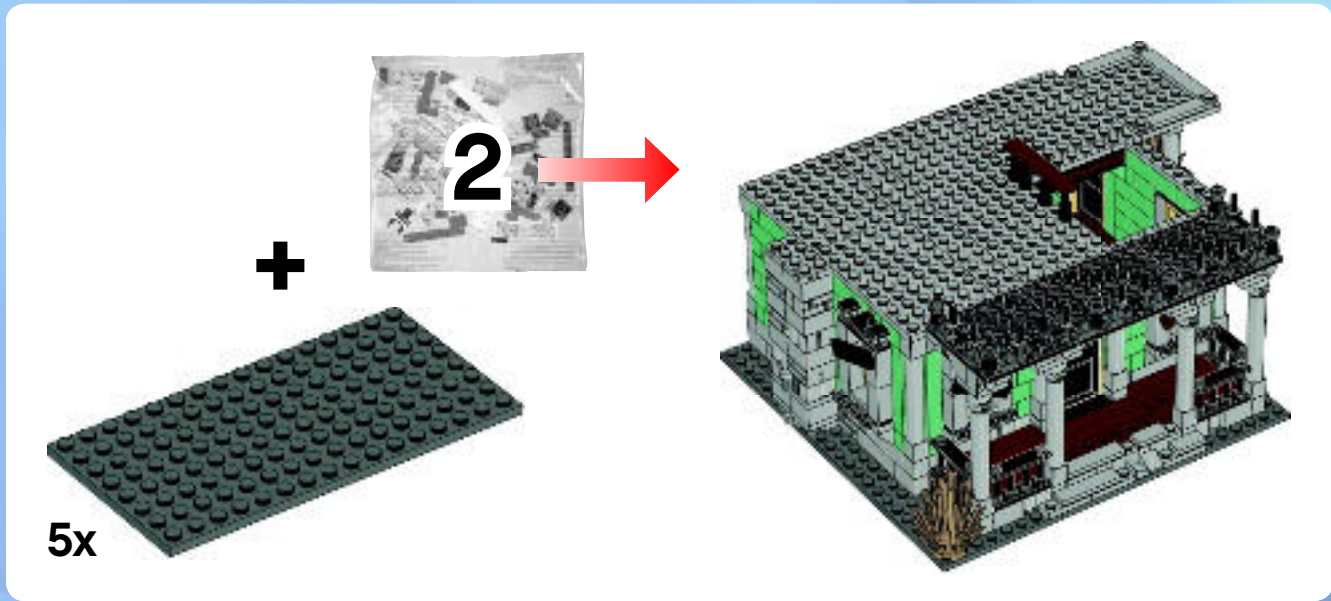

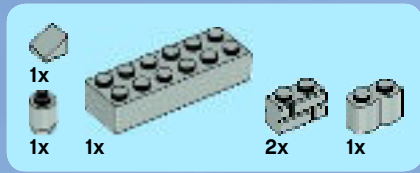

3

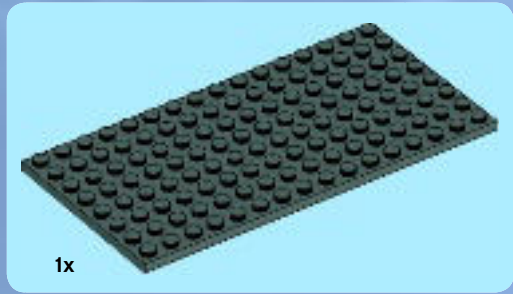
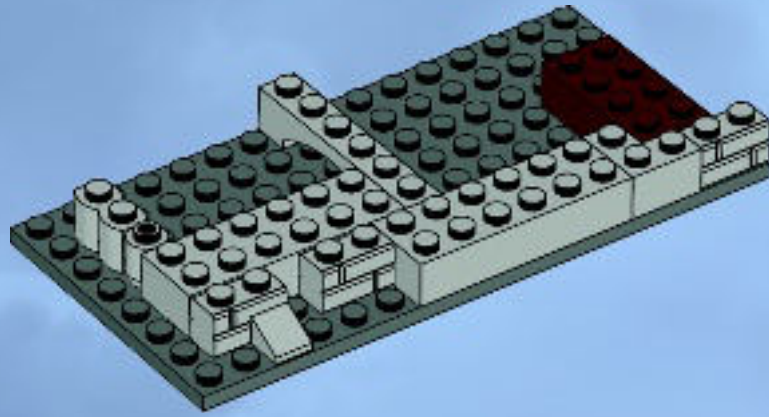

4

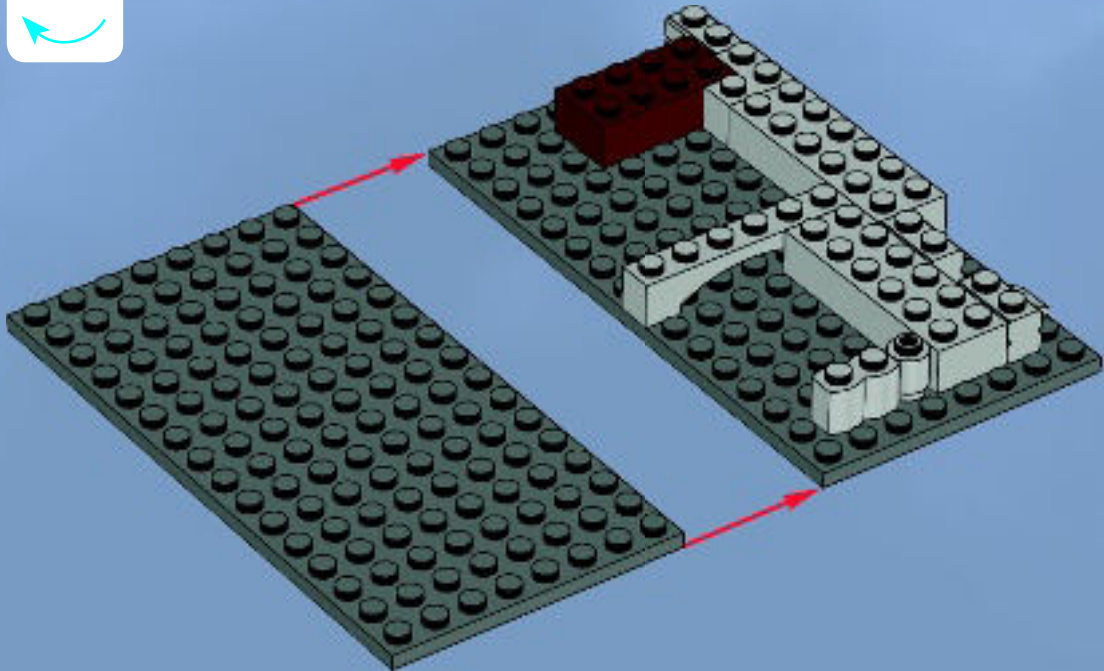



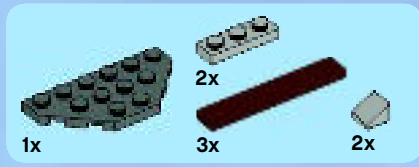

5

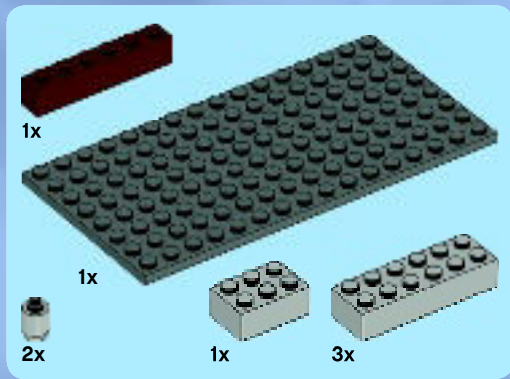
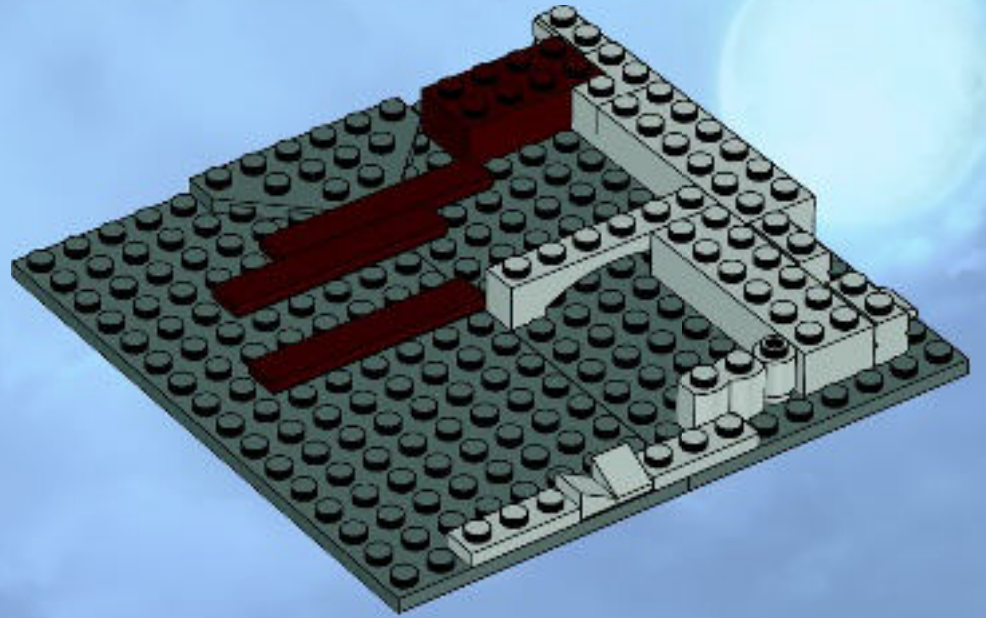

6

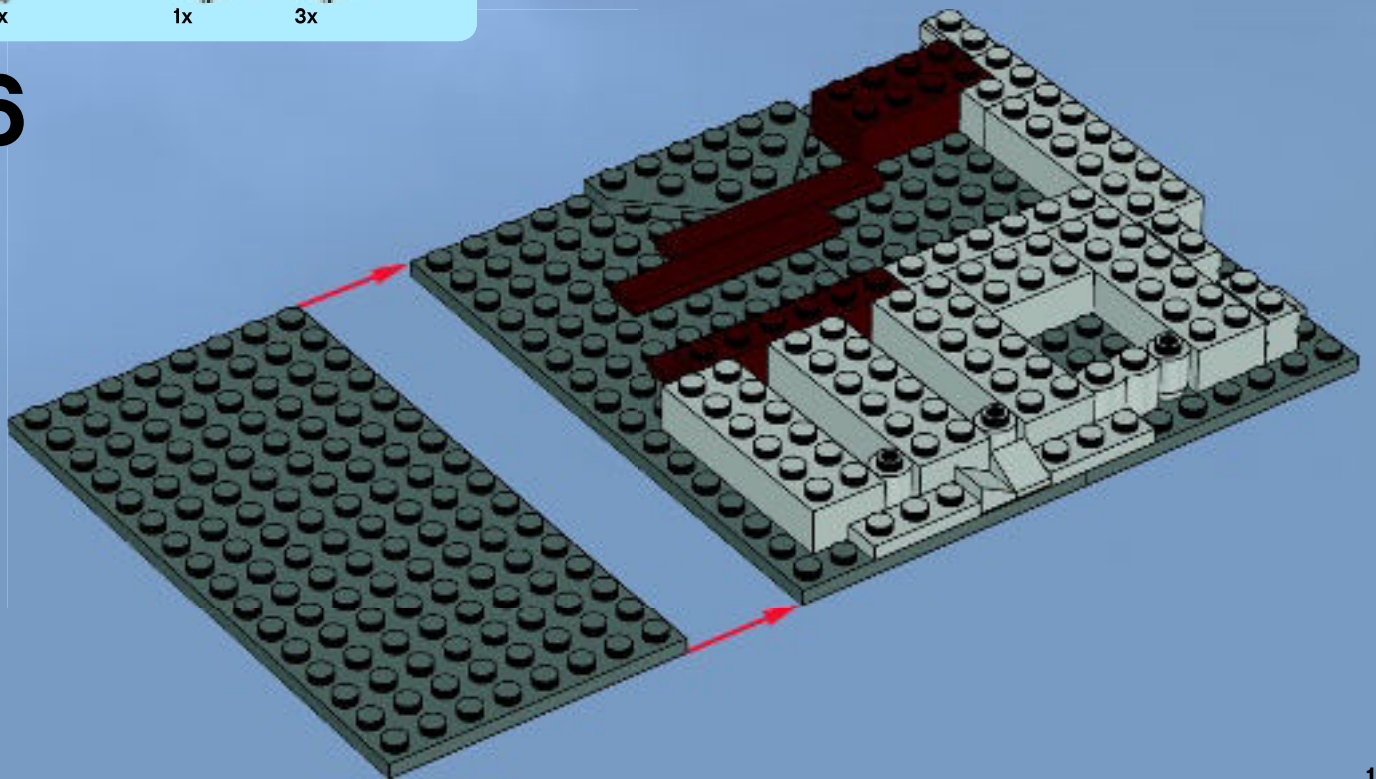



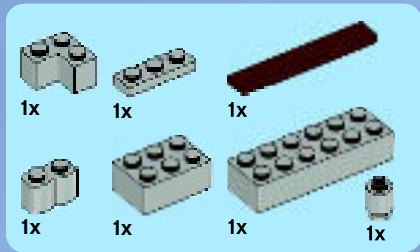

7

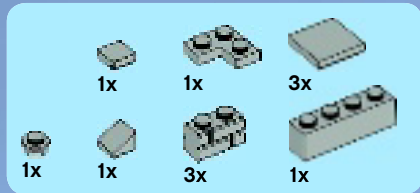
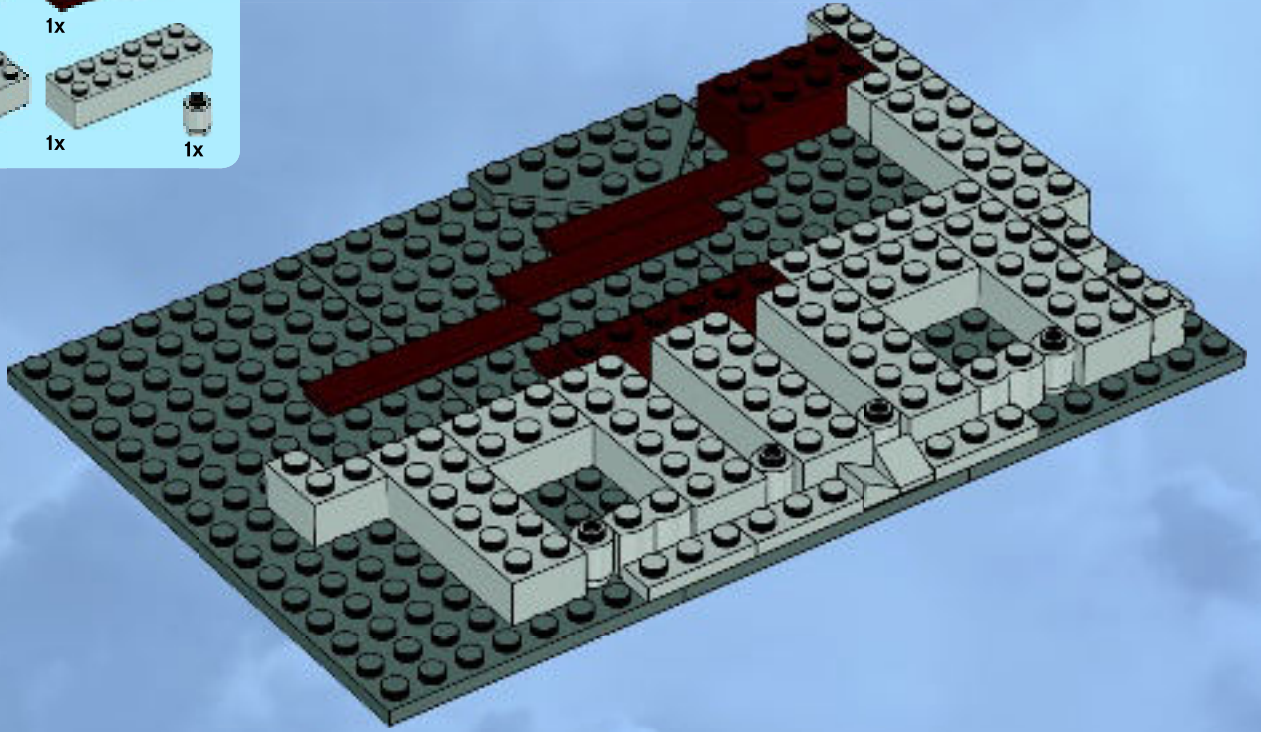

8

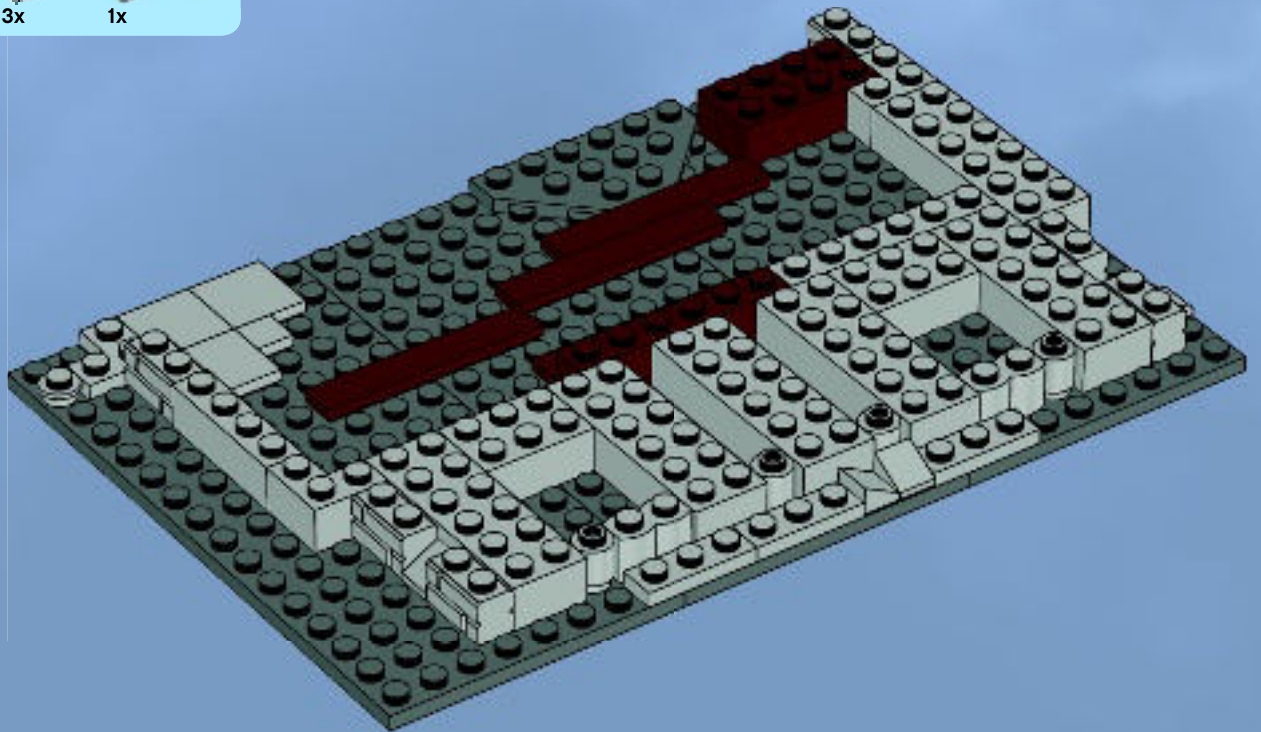

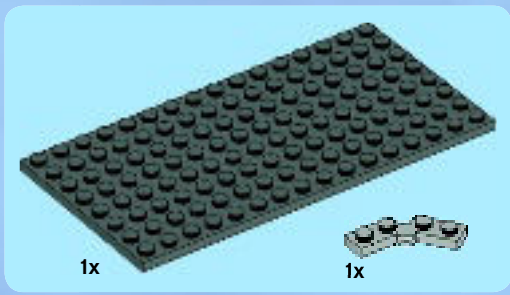

9

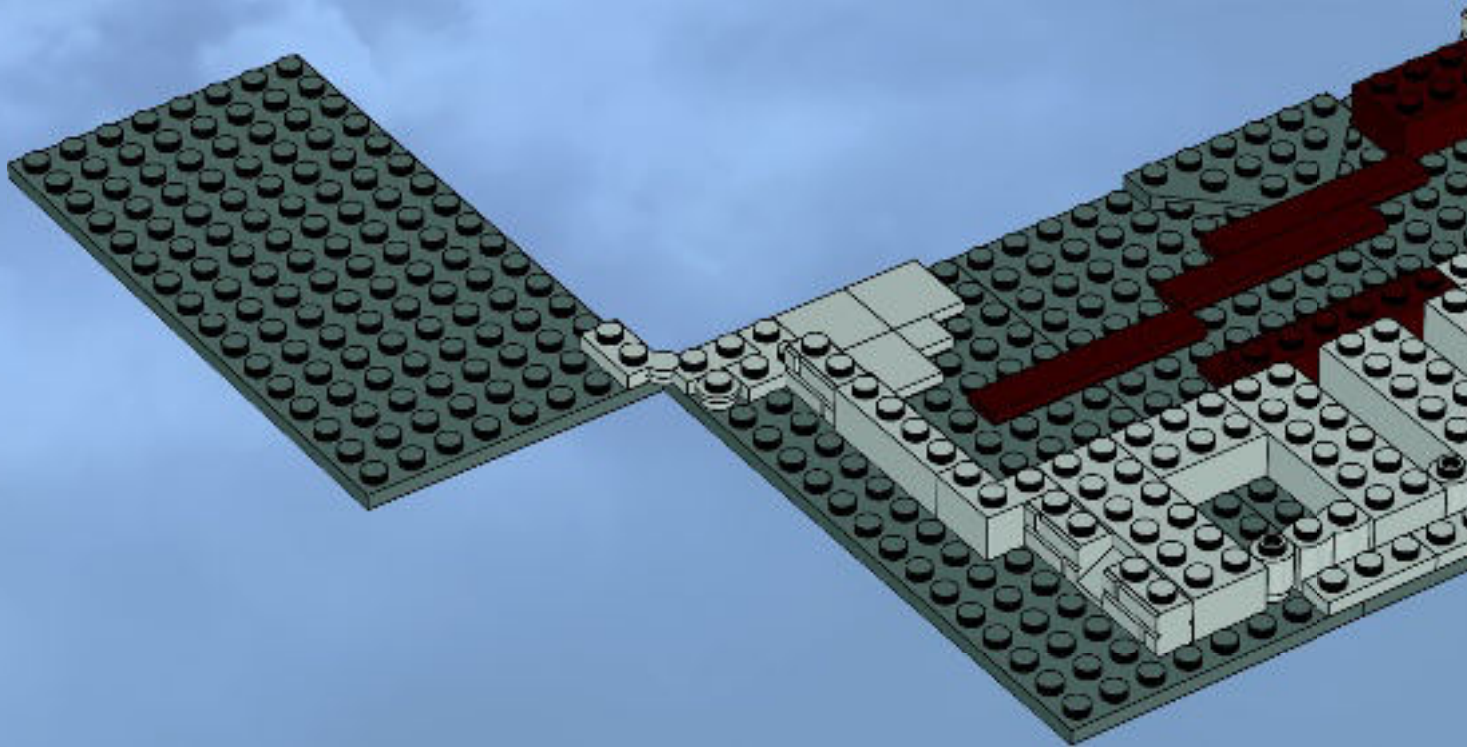





1x



1x



1x



3x

# 10

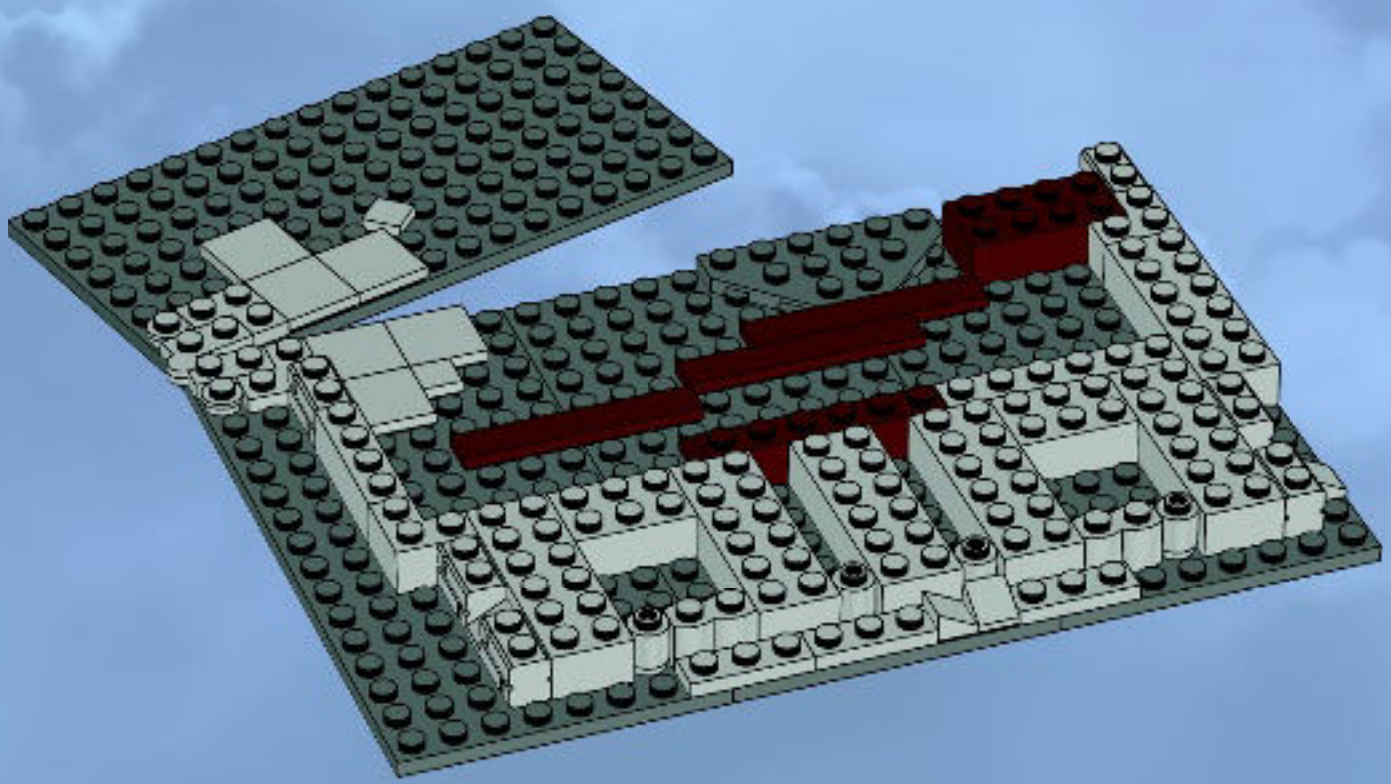

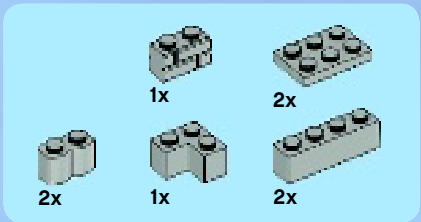

# 11

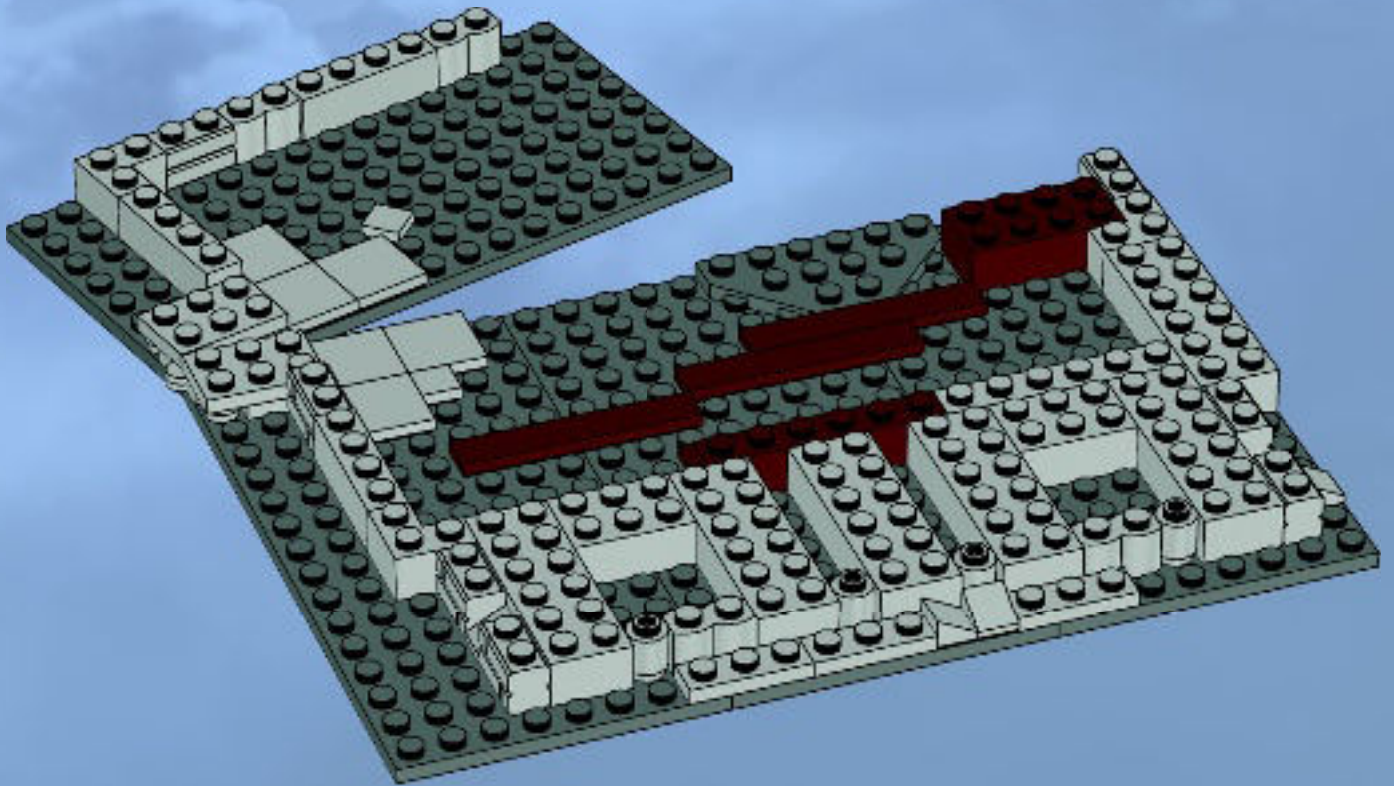



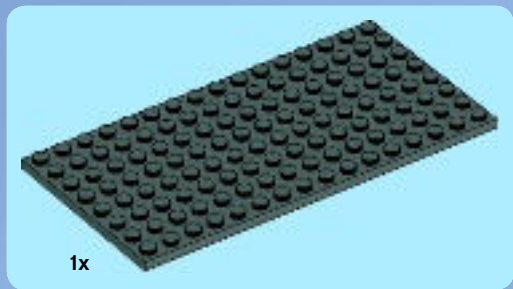

1x

# 12

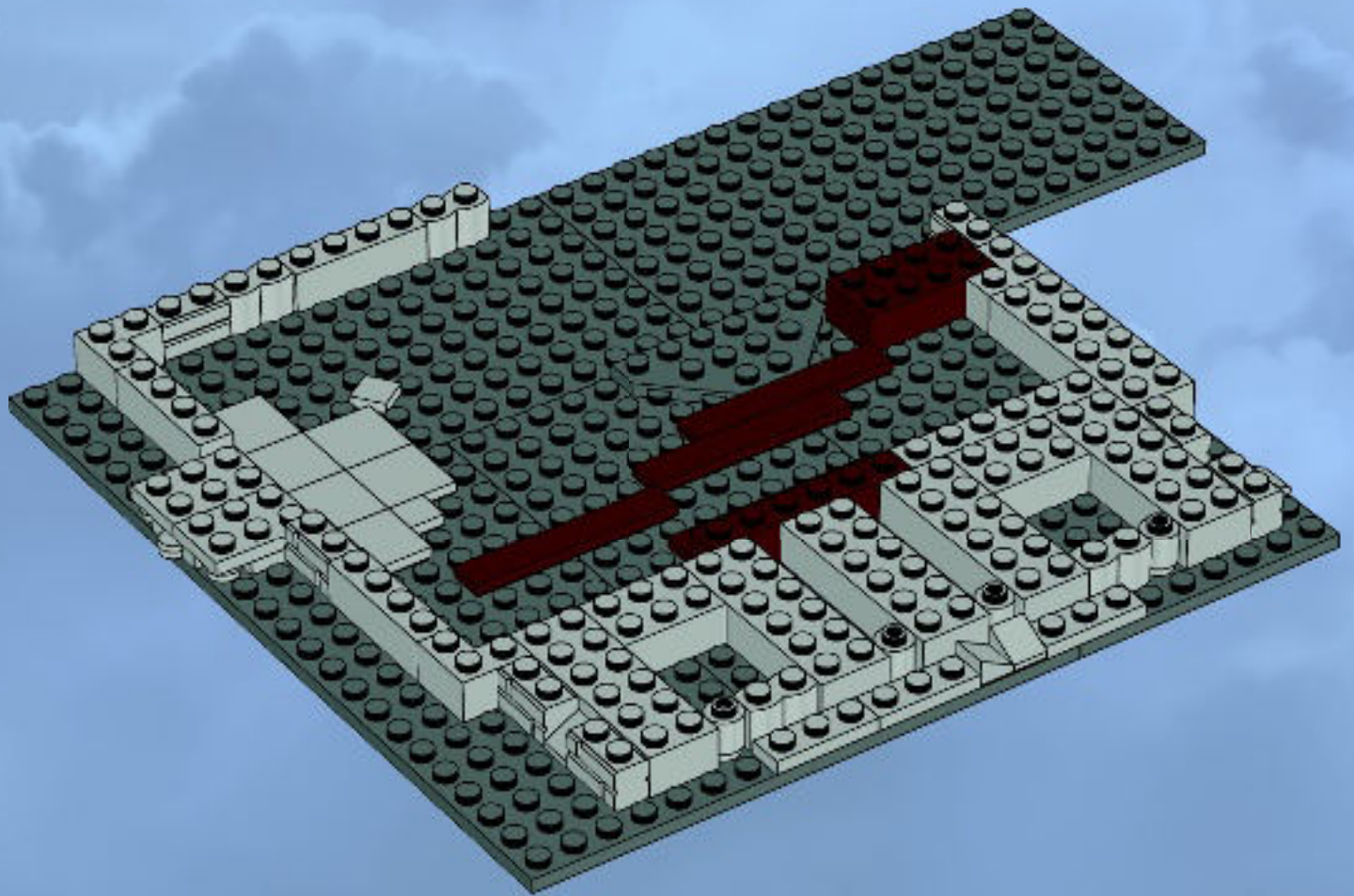

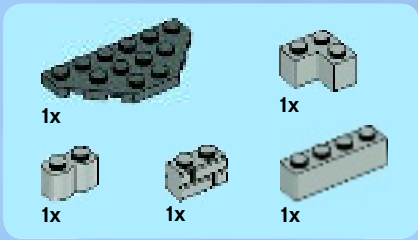

# 13

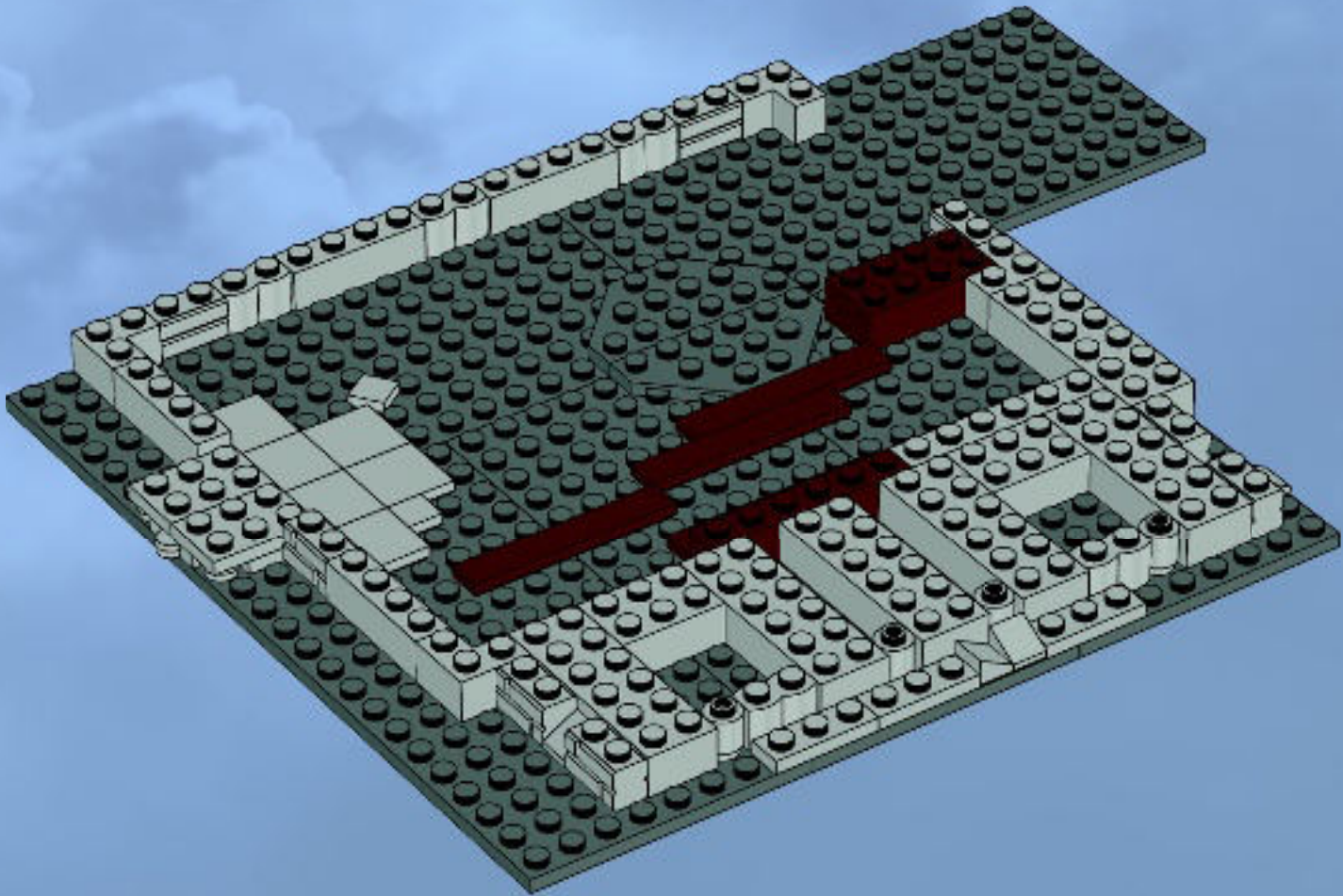



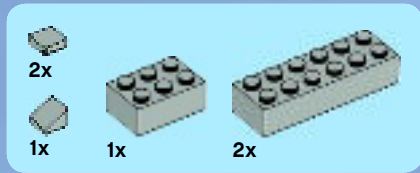

14

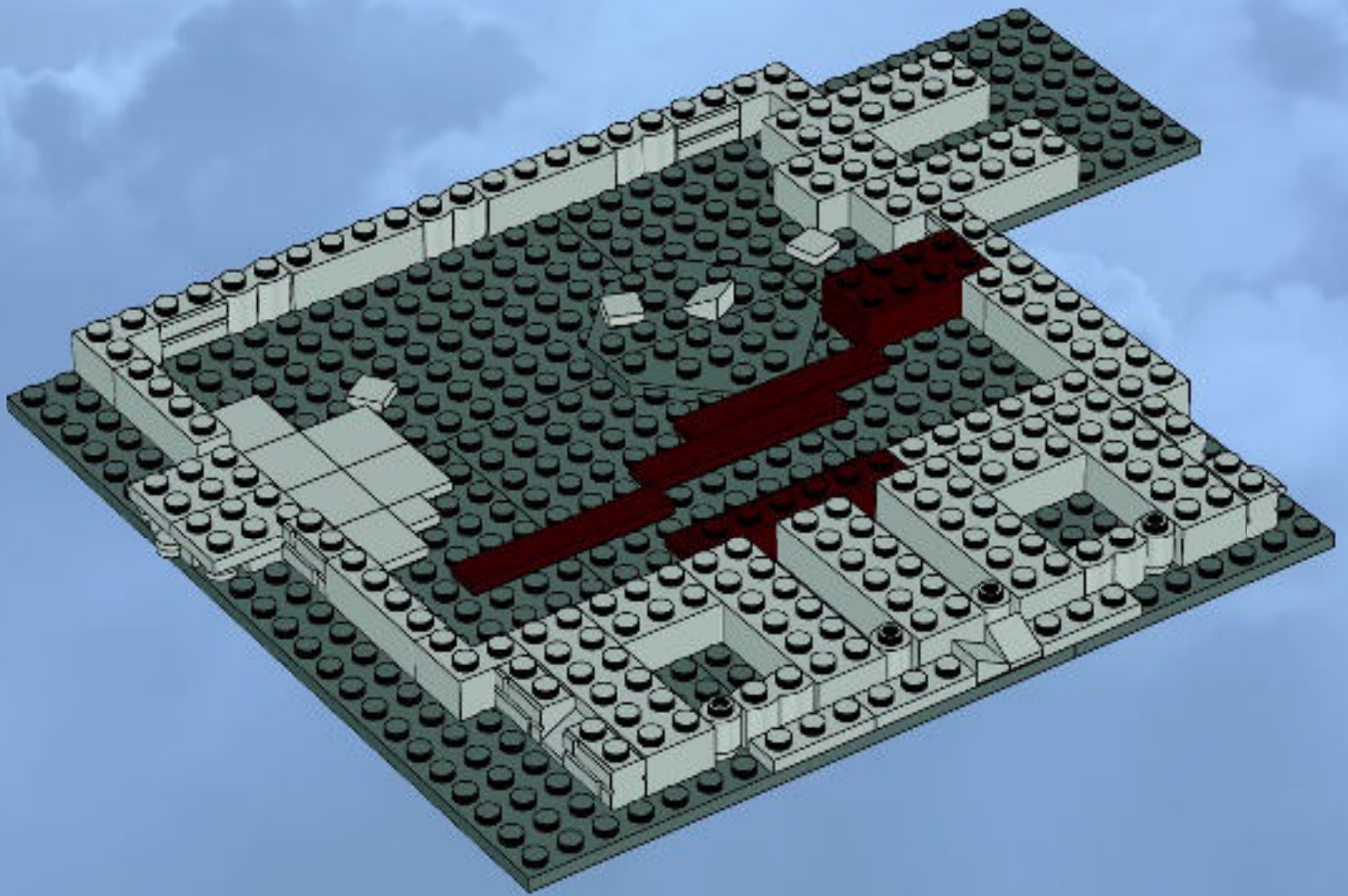

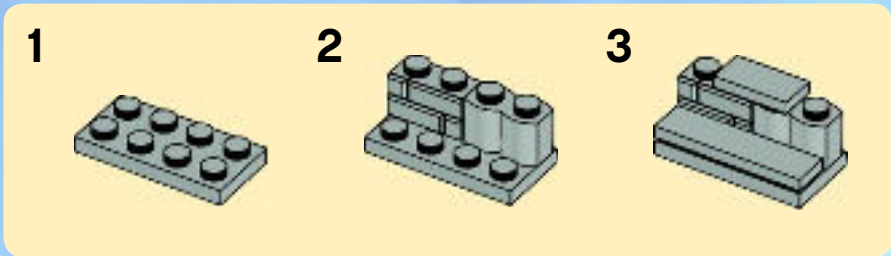
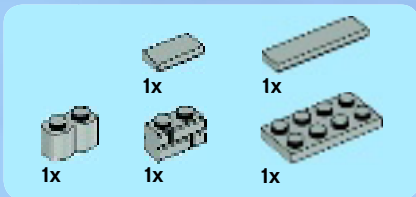

15

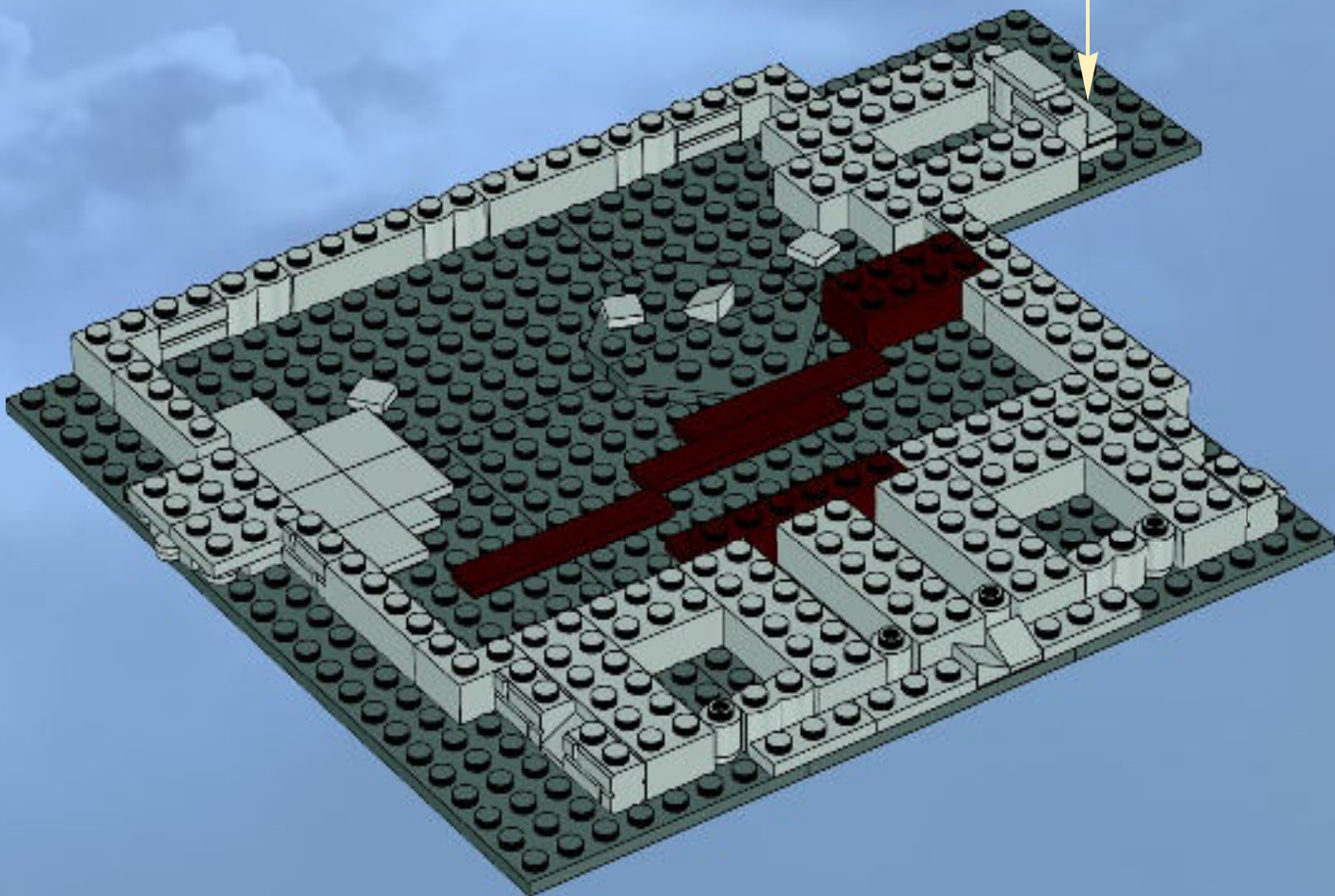



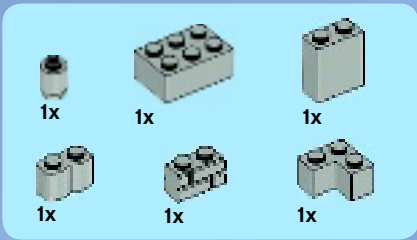

# 16

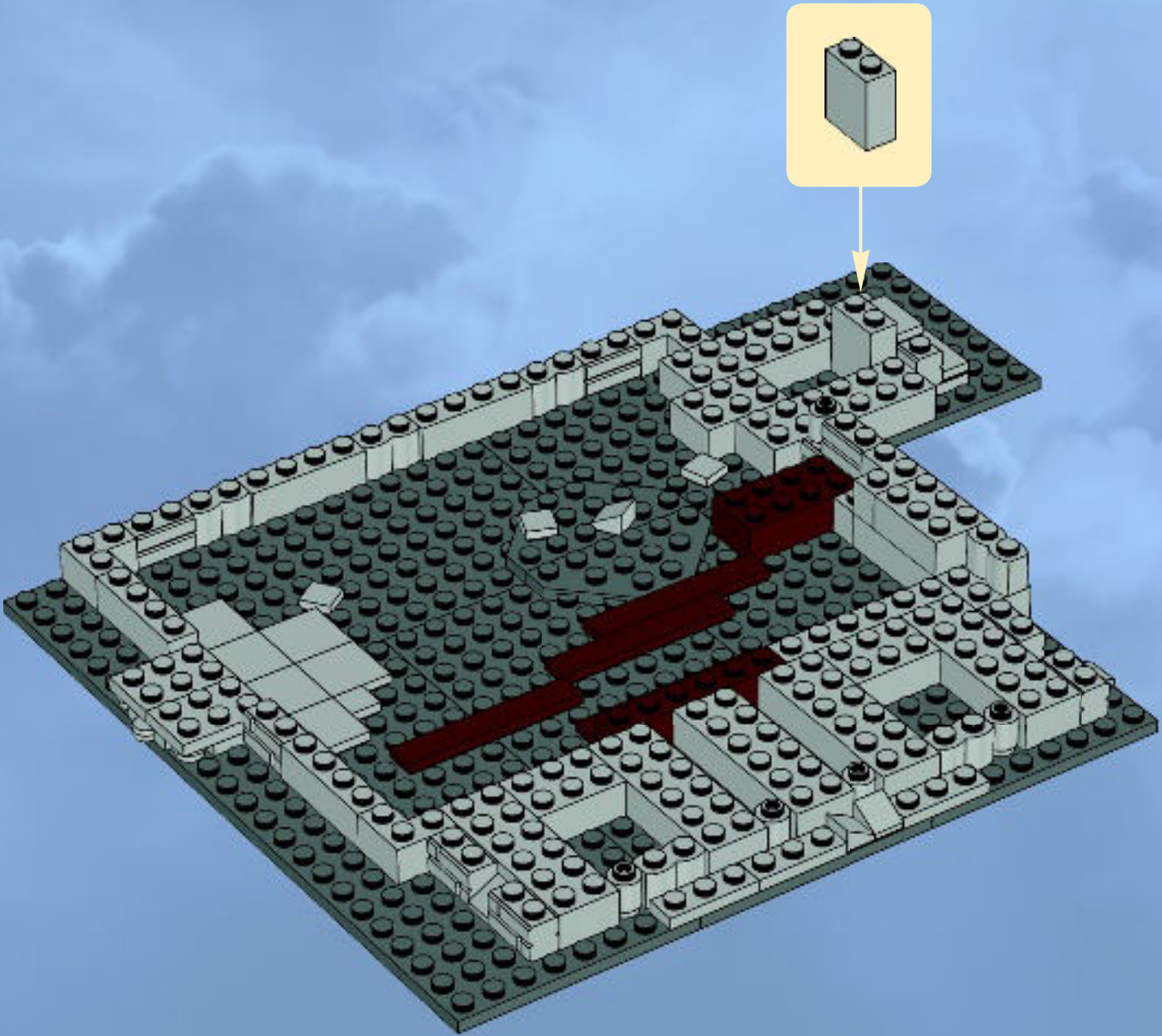

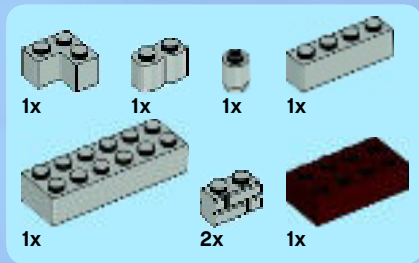

17

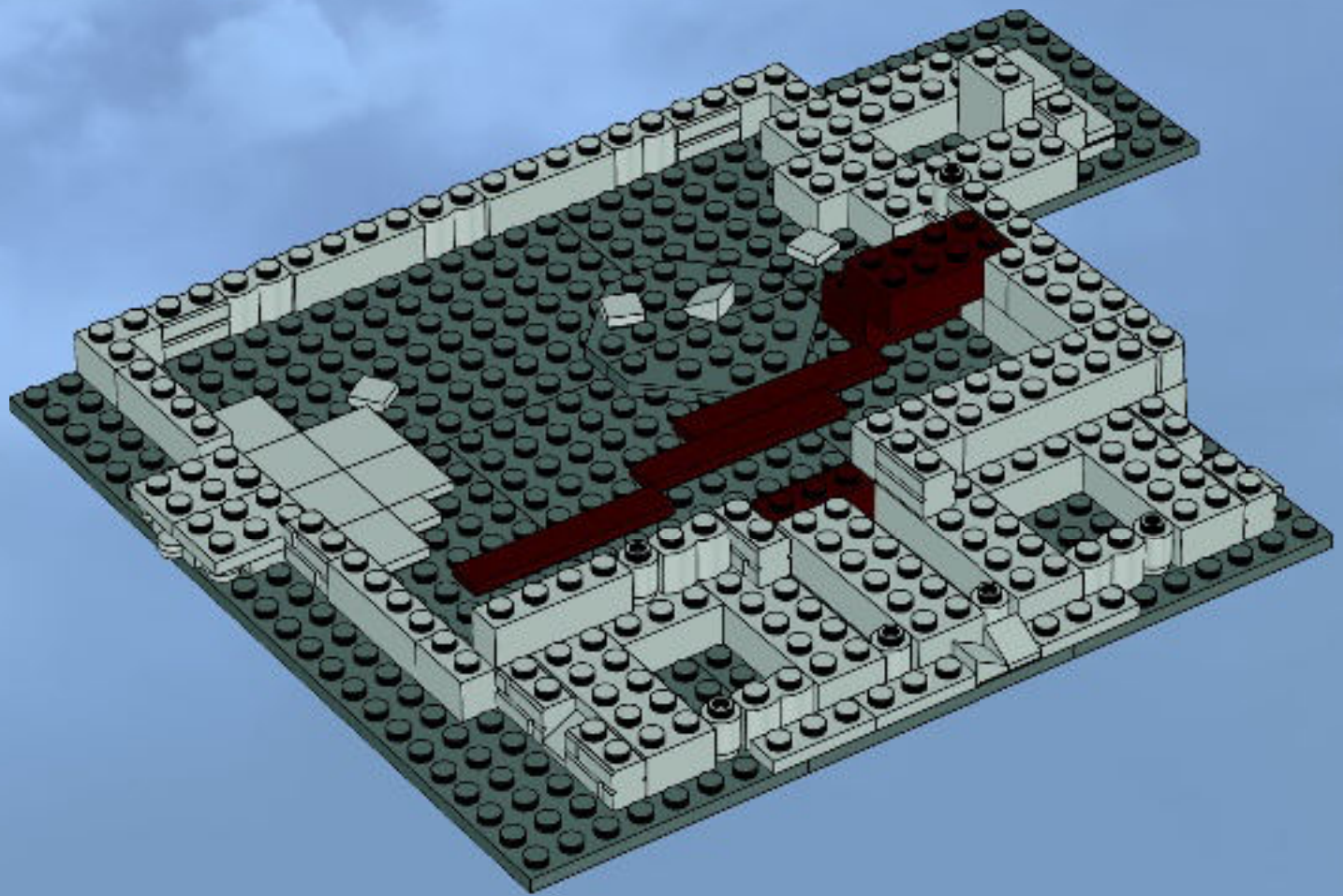



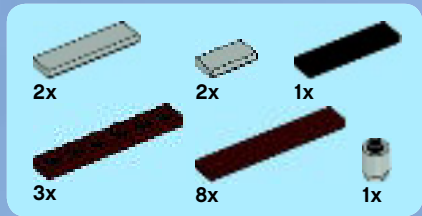

# 18

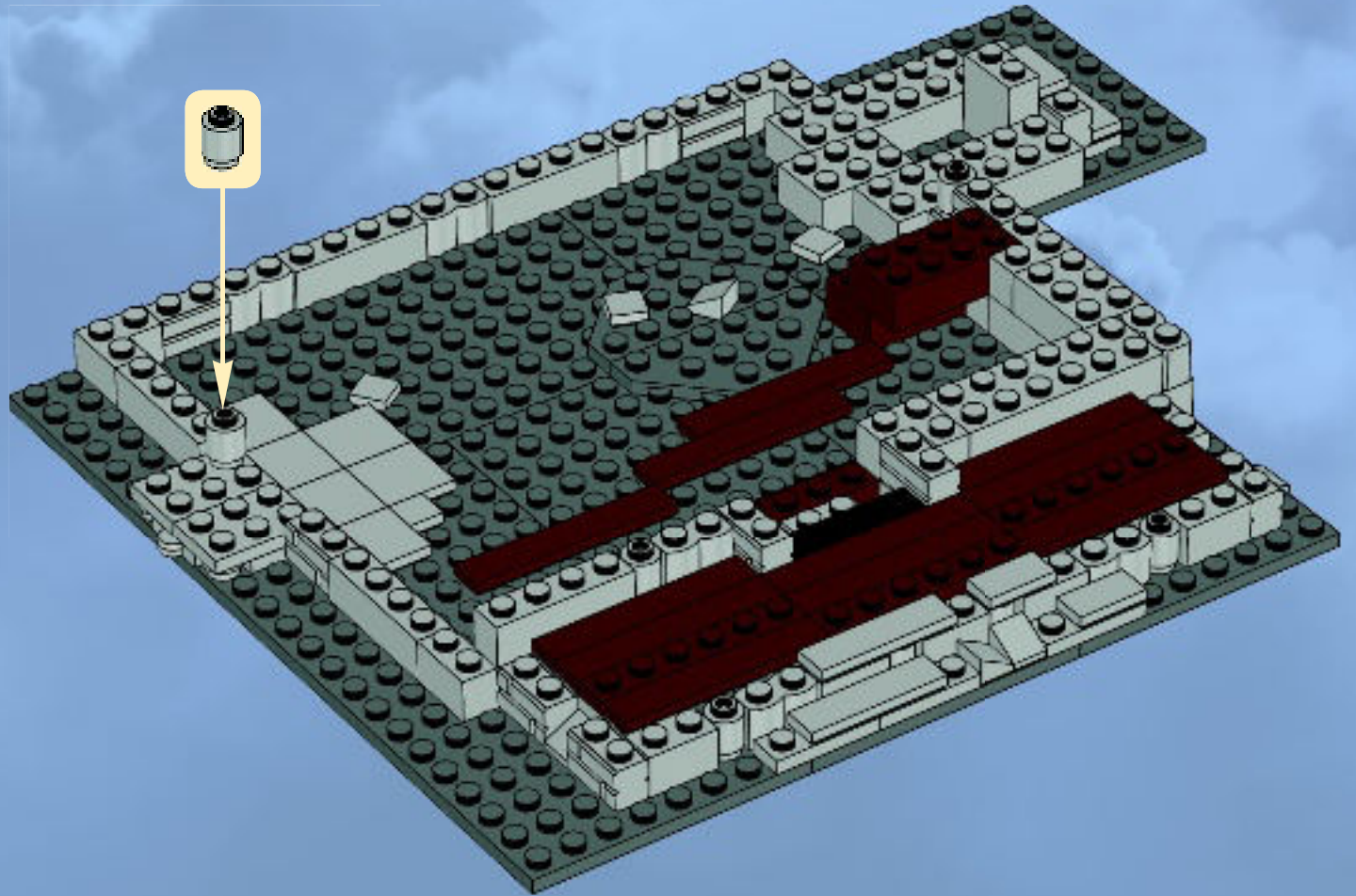



1x

1



1x



1x

2

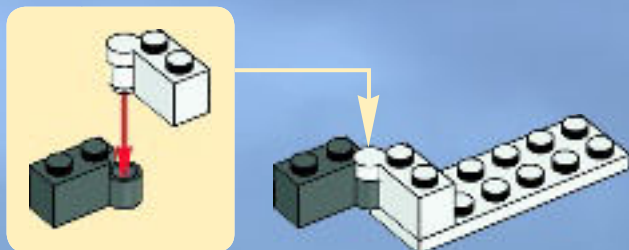

1x

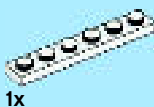

1x



2x

3

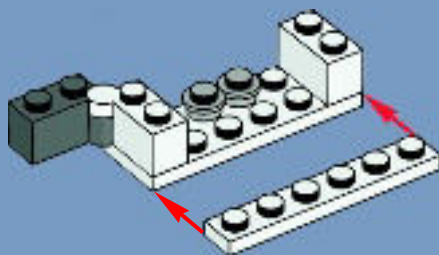

2x



2x

4

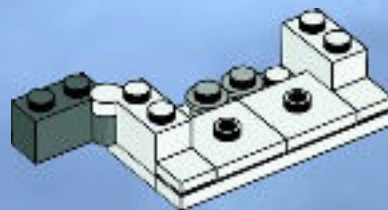

1x



1x

5

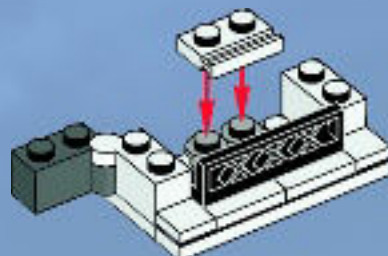

2x

6







2x



1x



2x

# 7

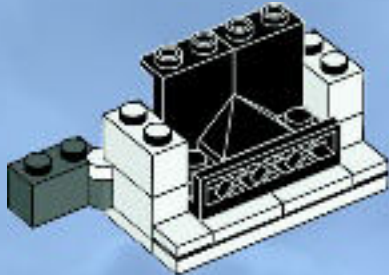

2x



1x

# 8

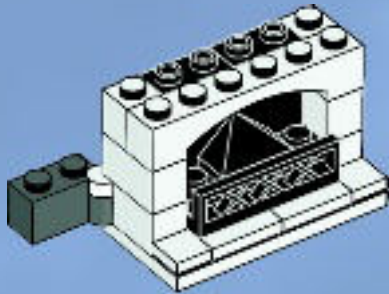

1x



3x

# 9

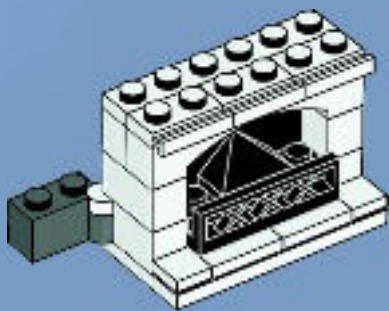

4x

# 10

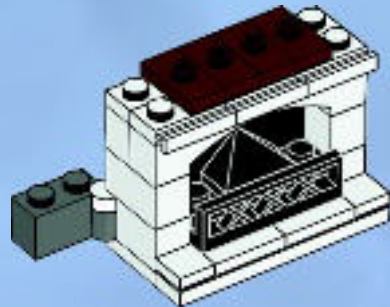

1x



2x

# 11

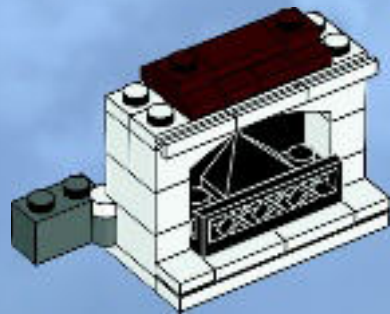

1x



1x

# 12

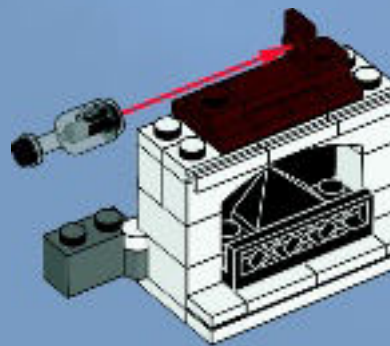

19

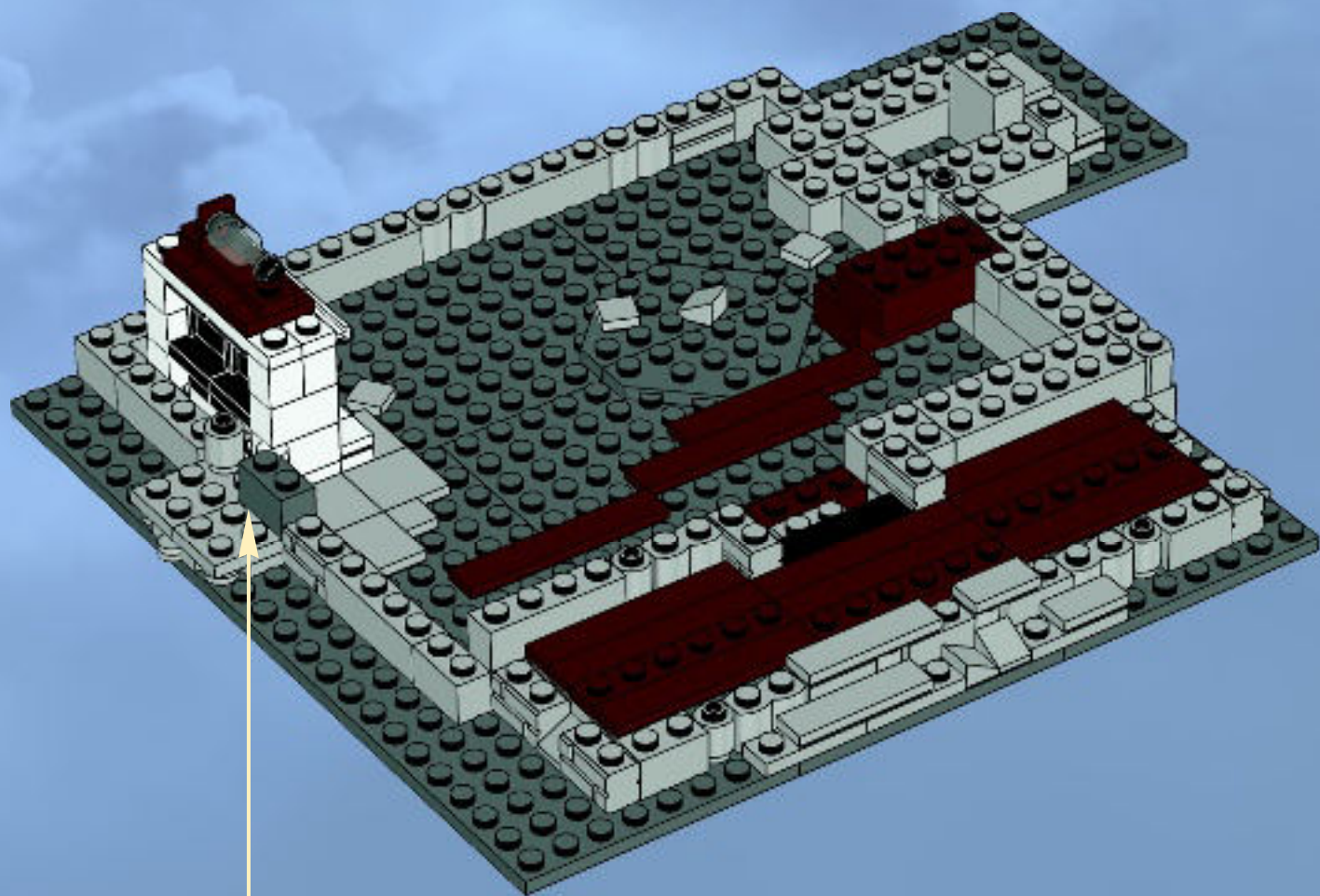

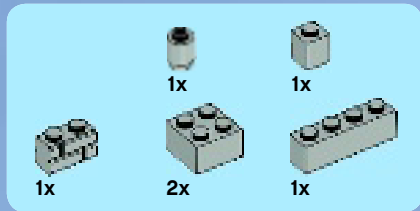

# 20

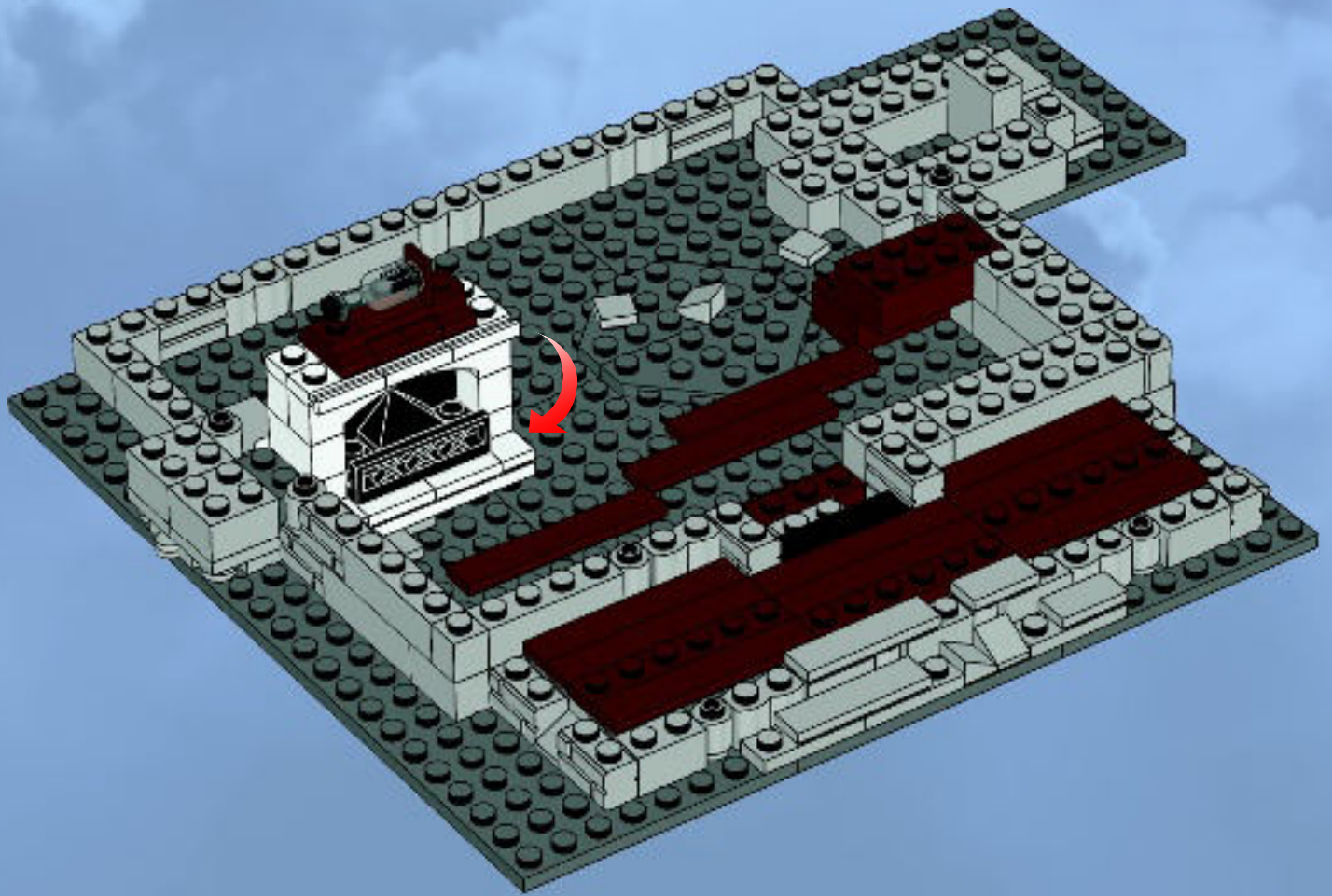



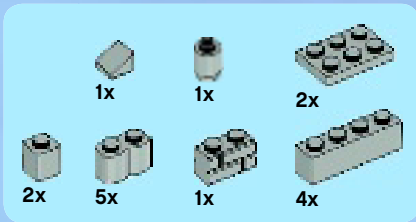

# 21

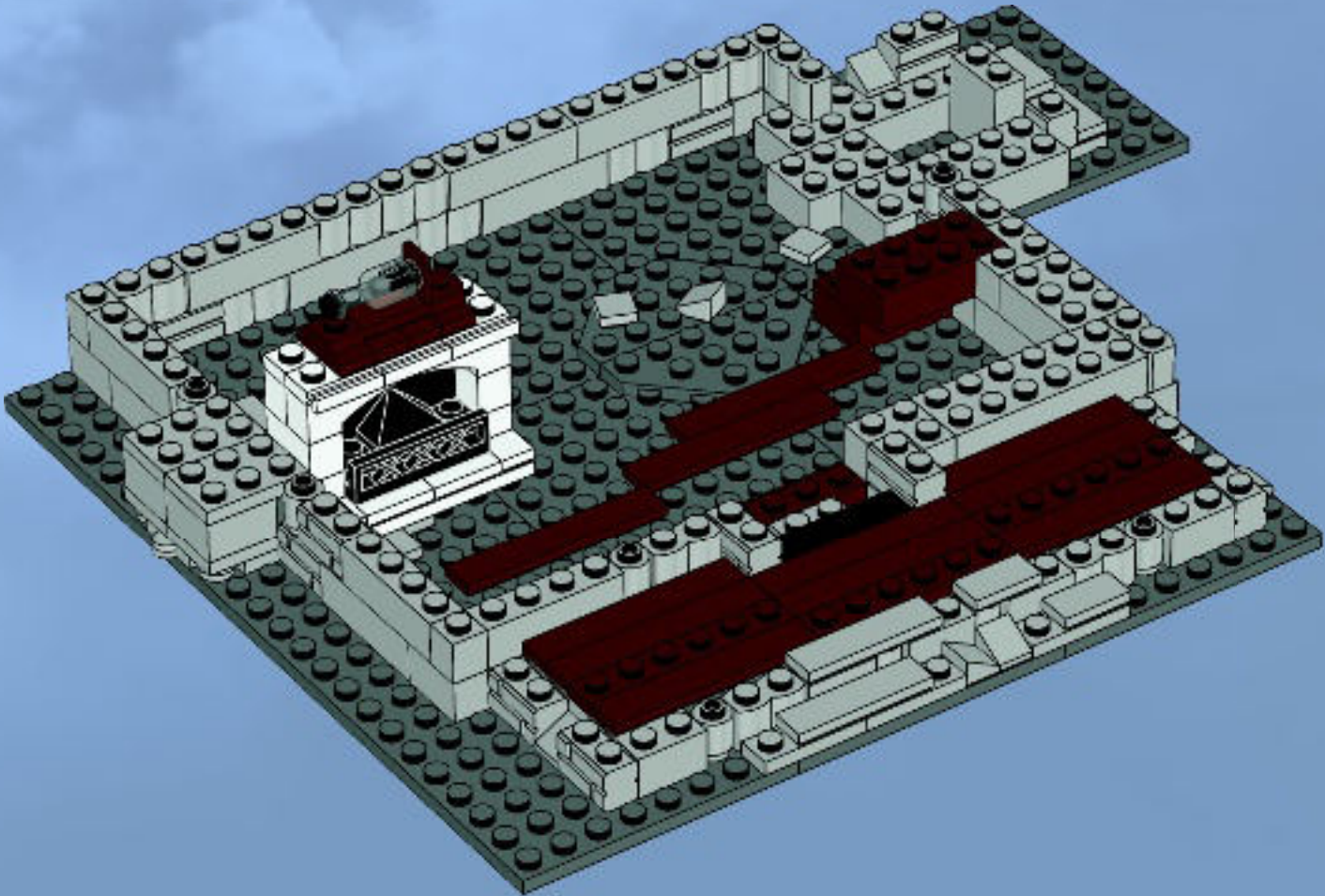

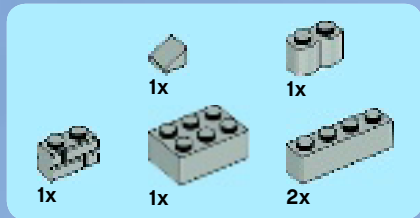

22

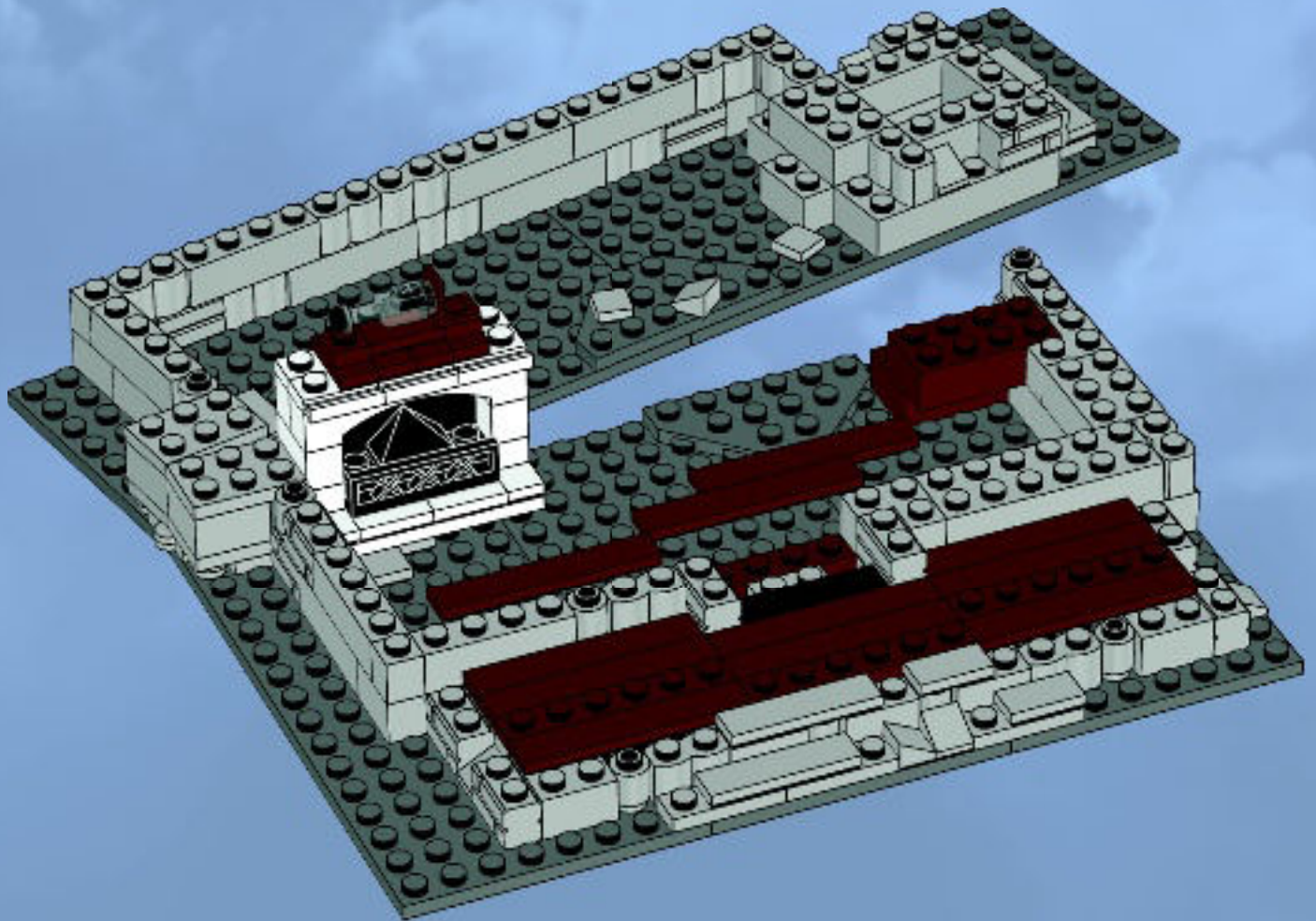



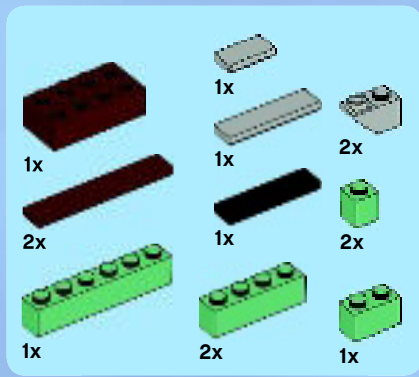

# 23

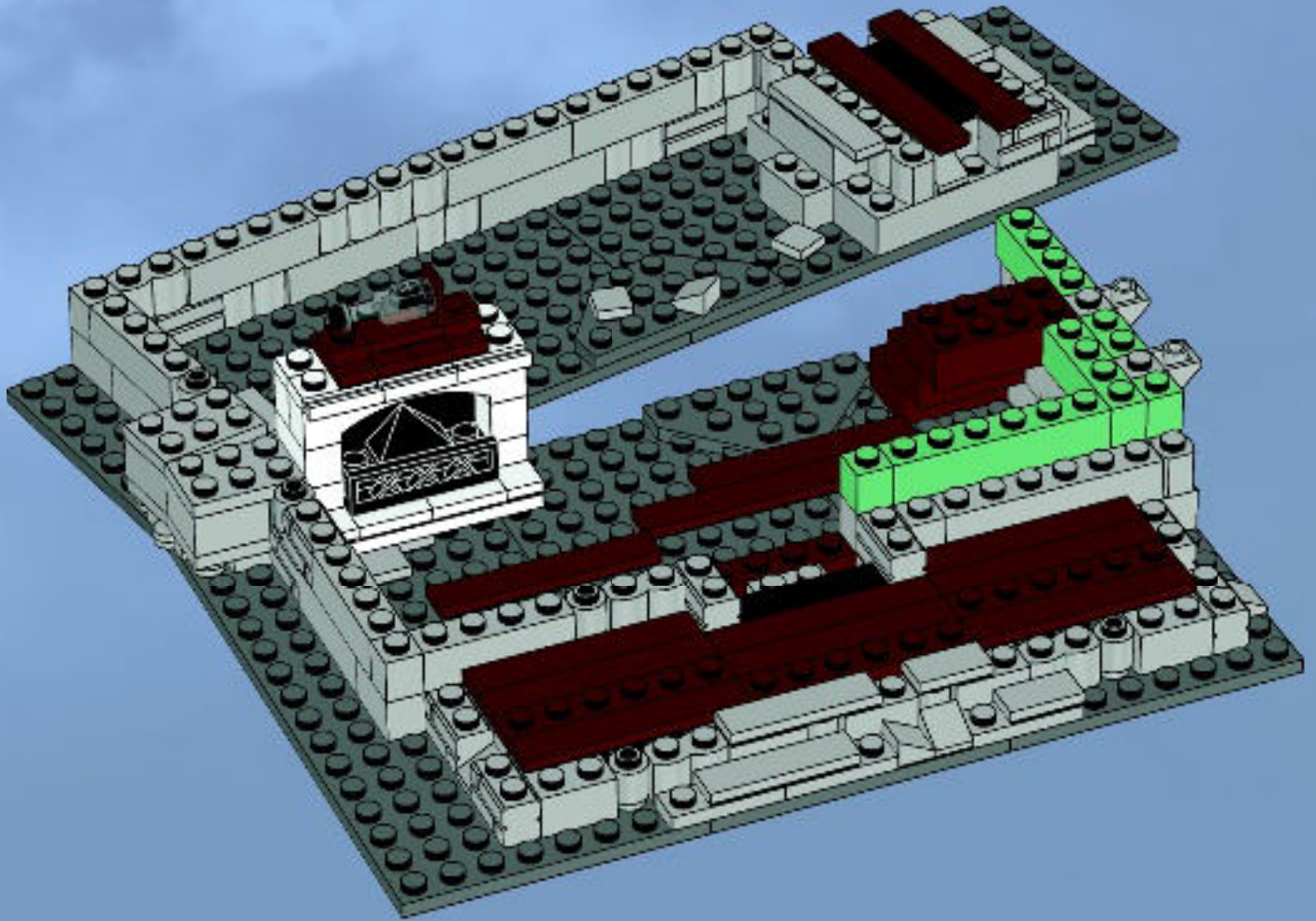





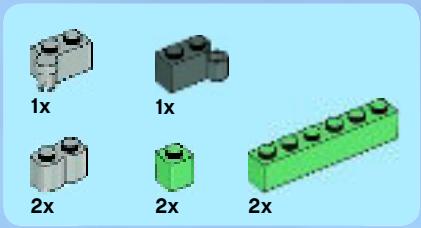

# 25

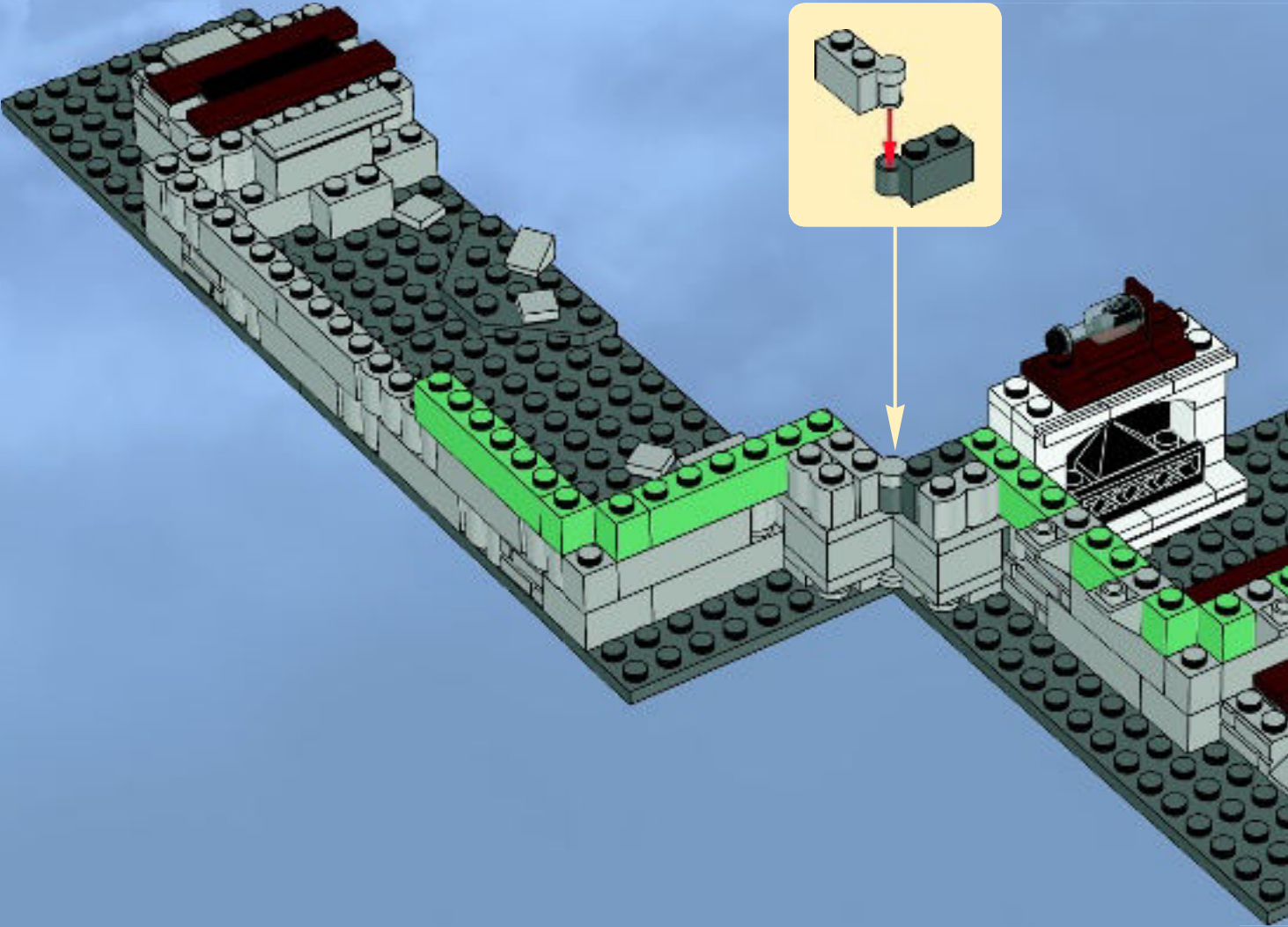



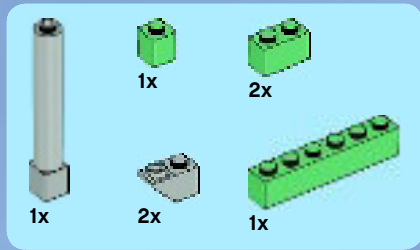

# 26

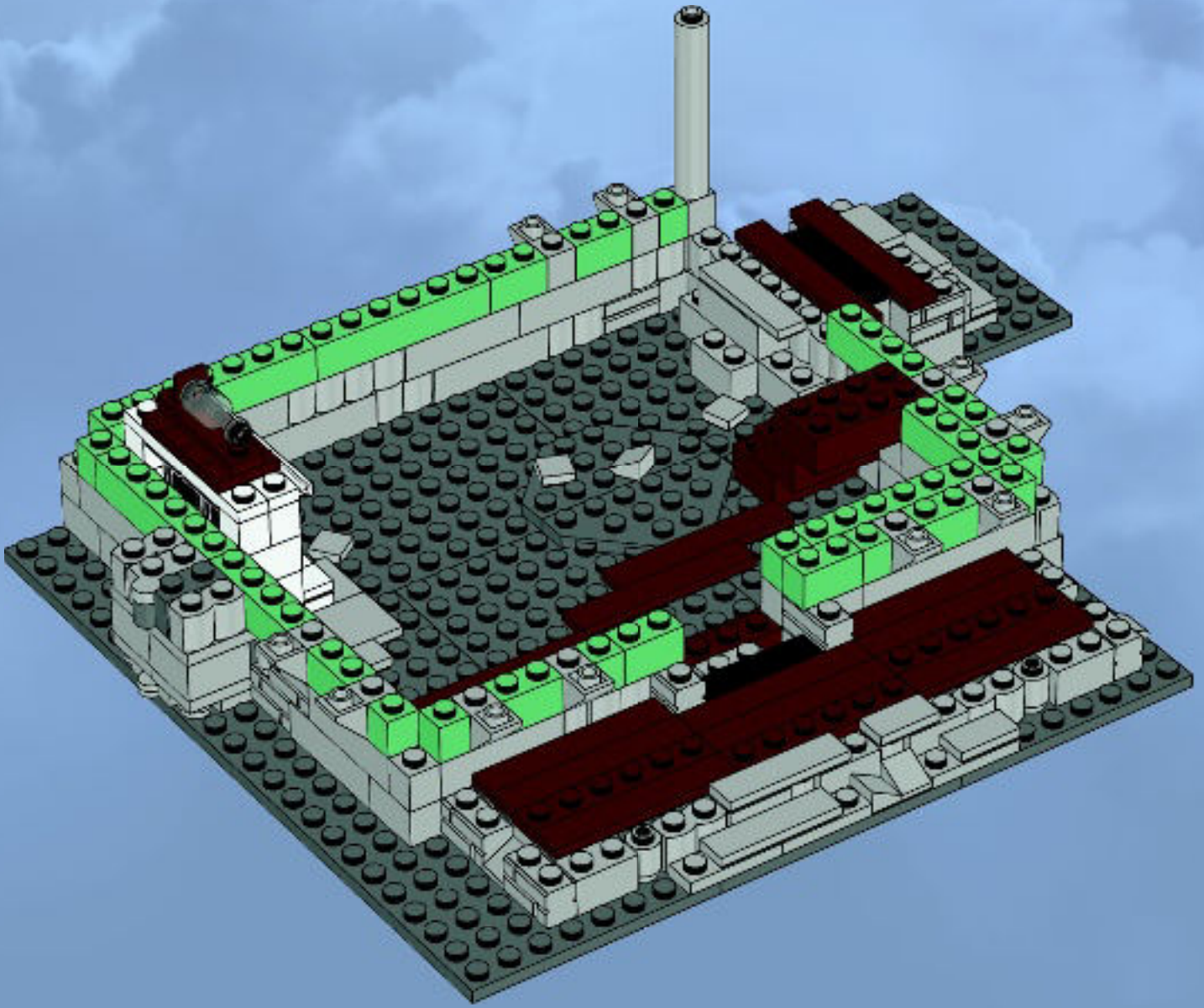



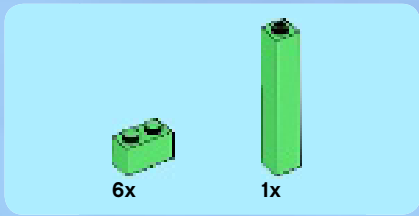

27

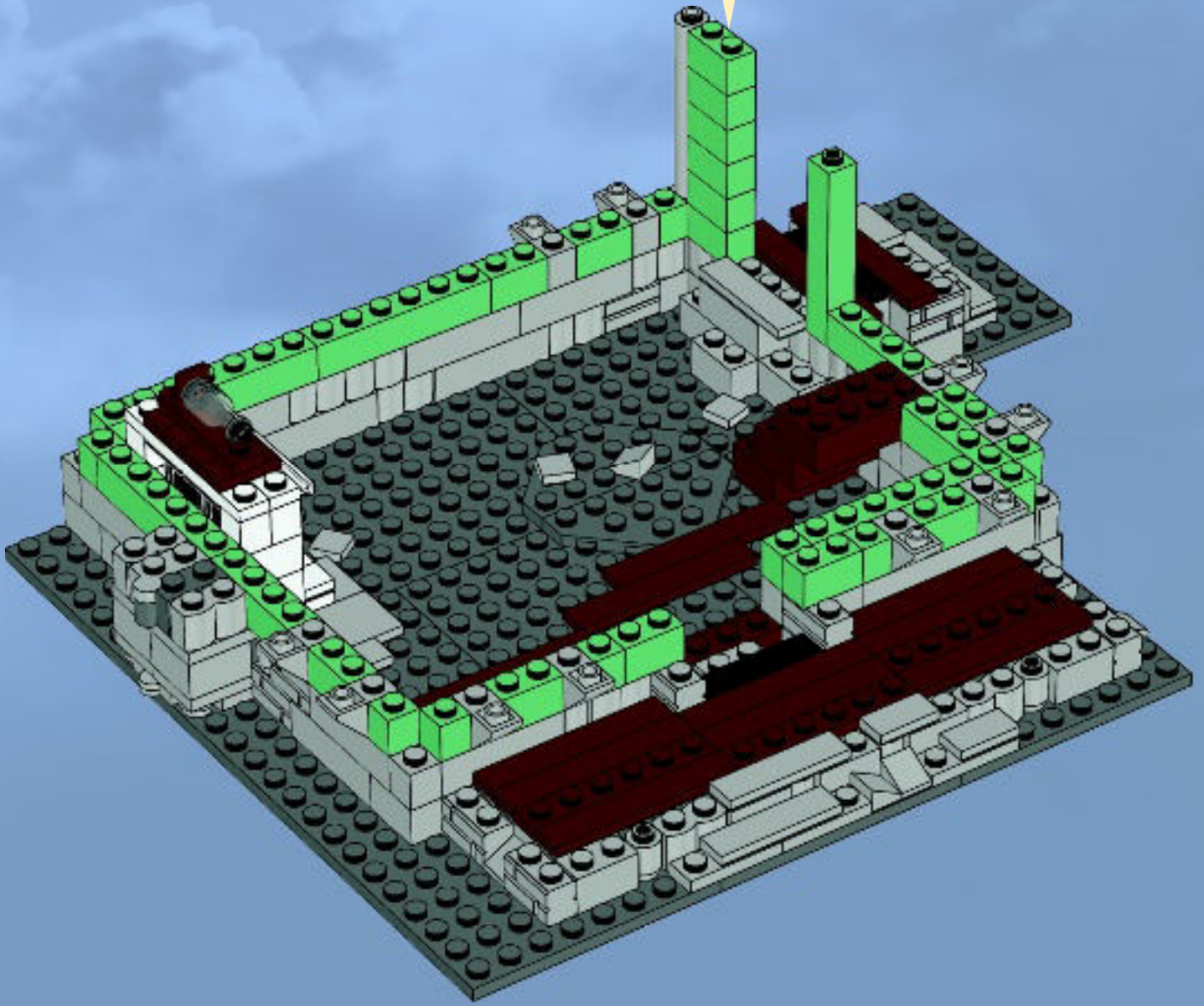
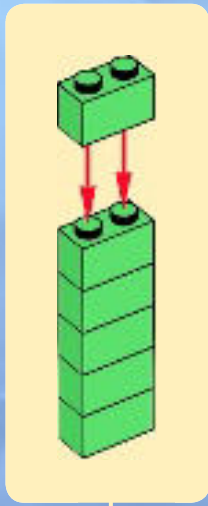

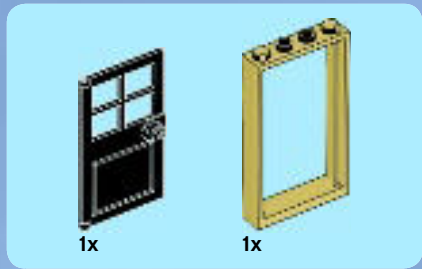

28

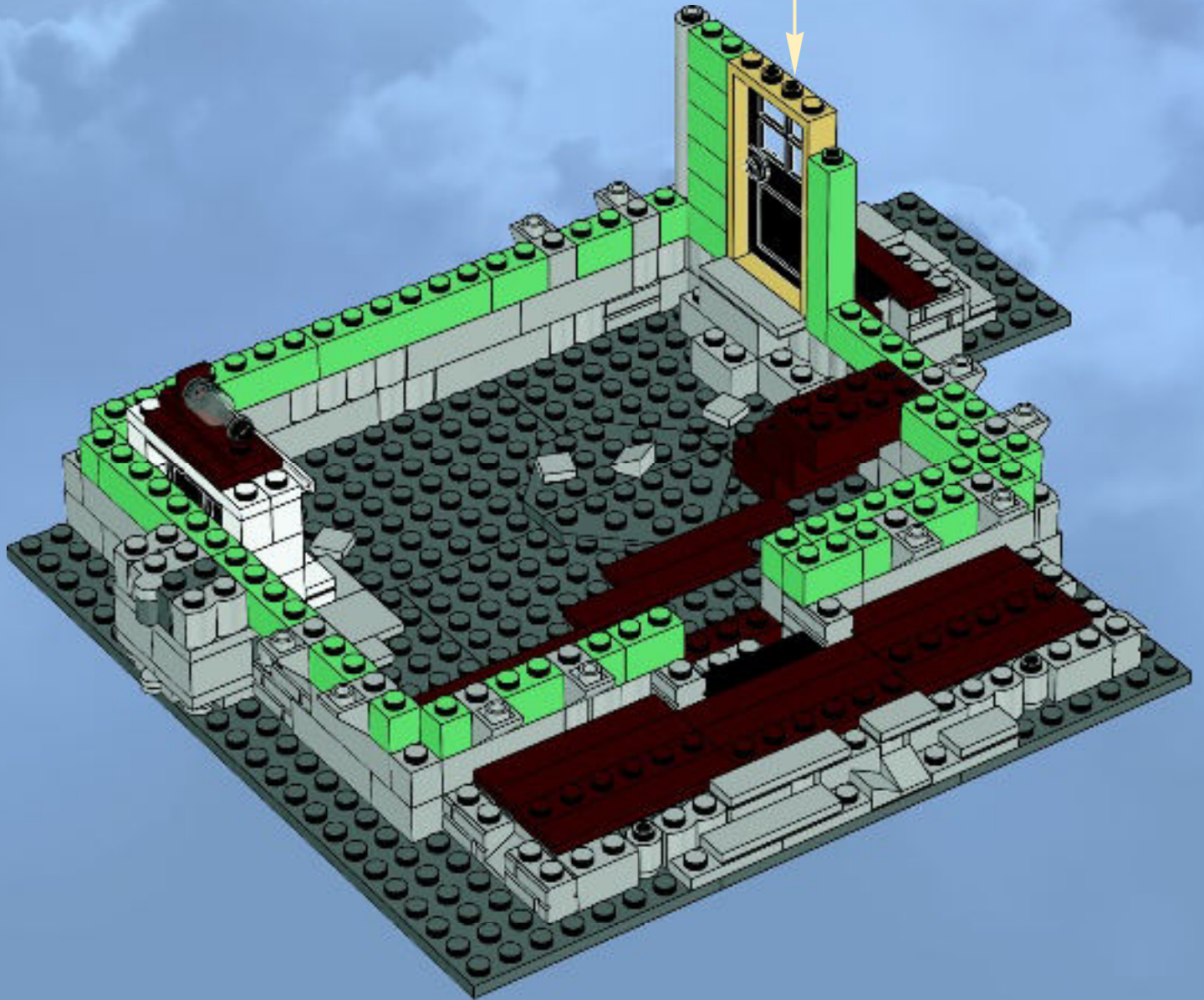
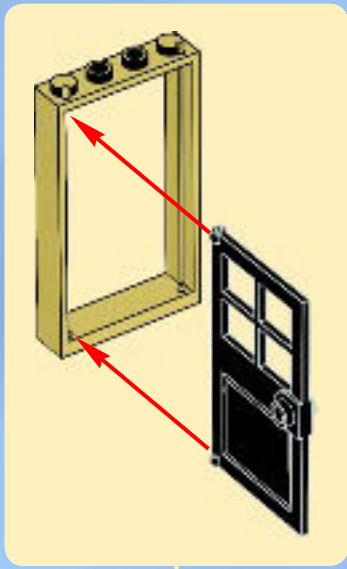



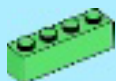

4x

# 29

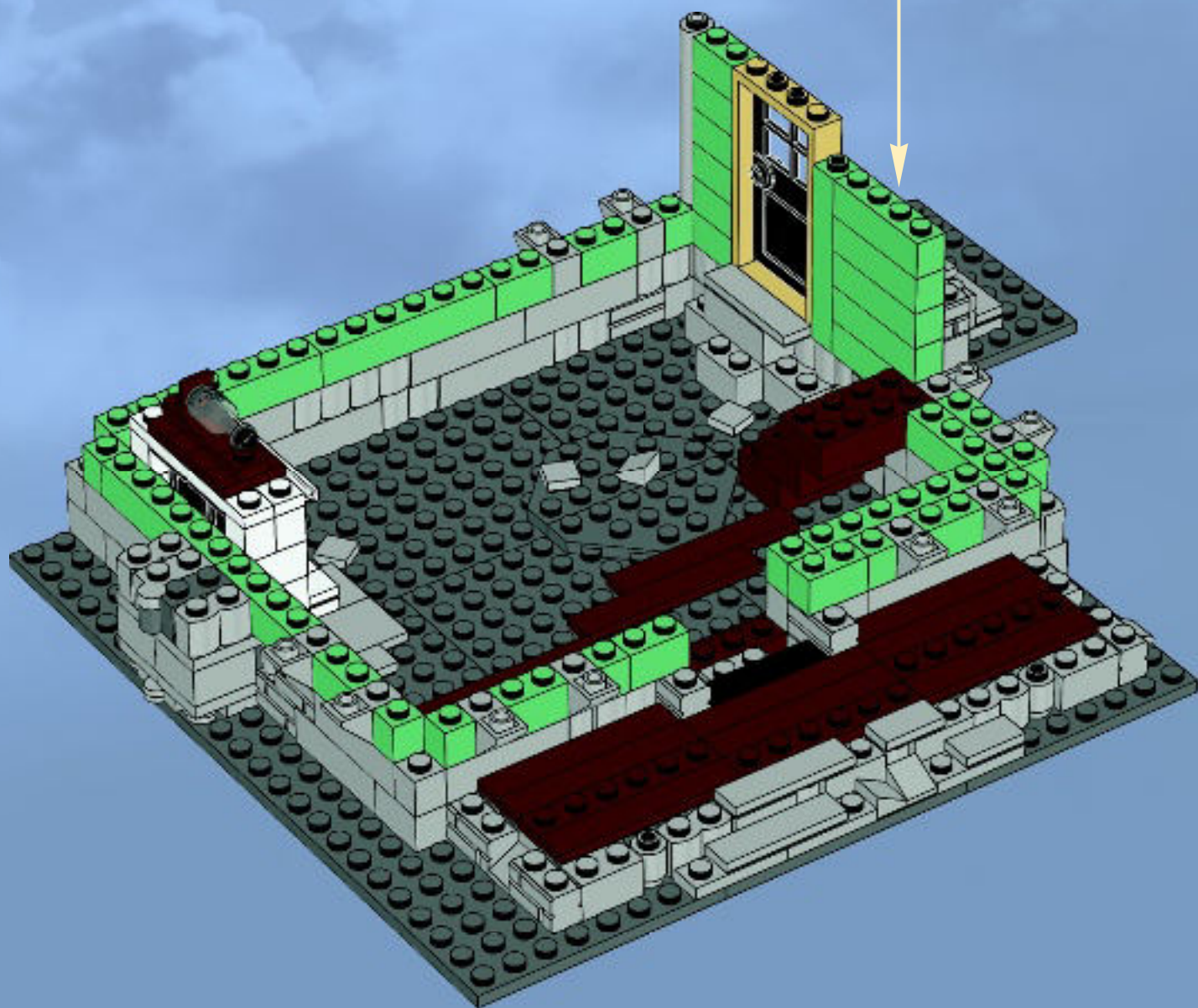
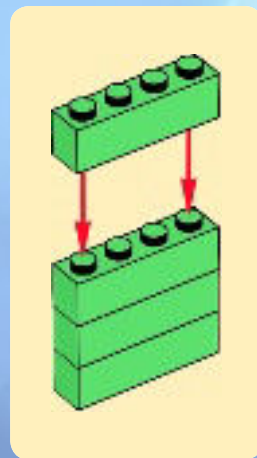



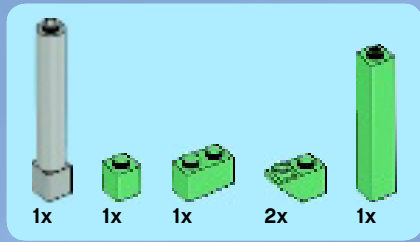

30

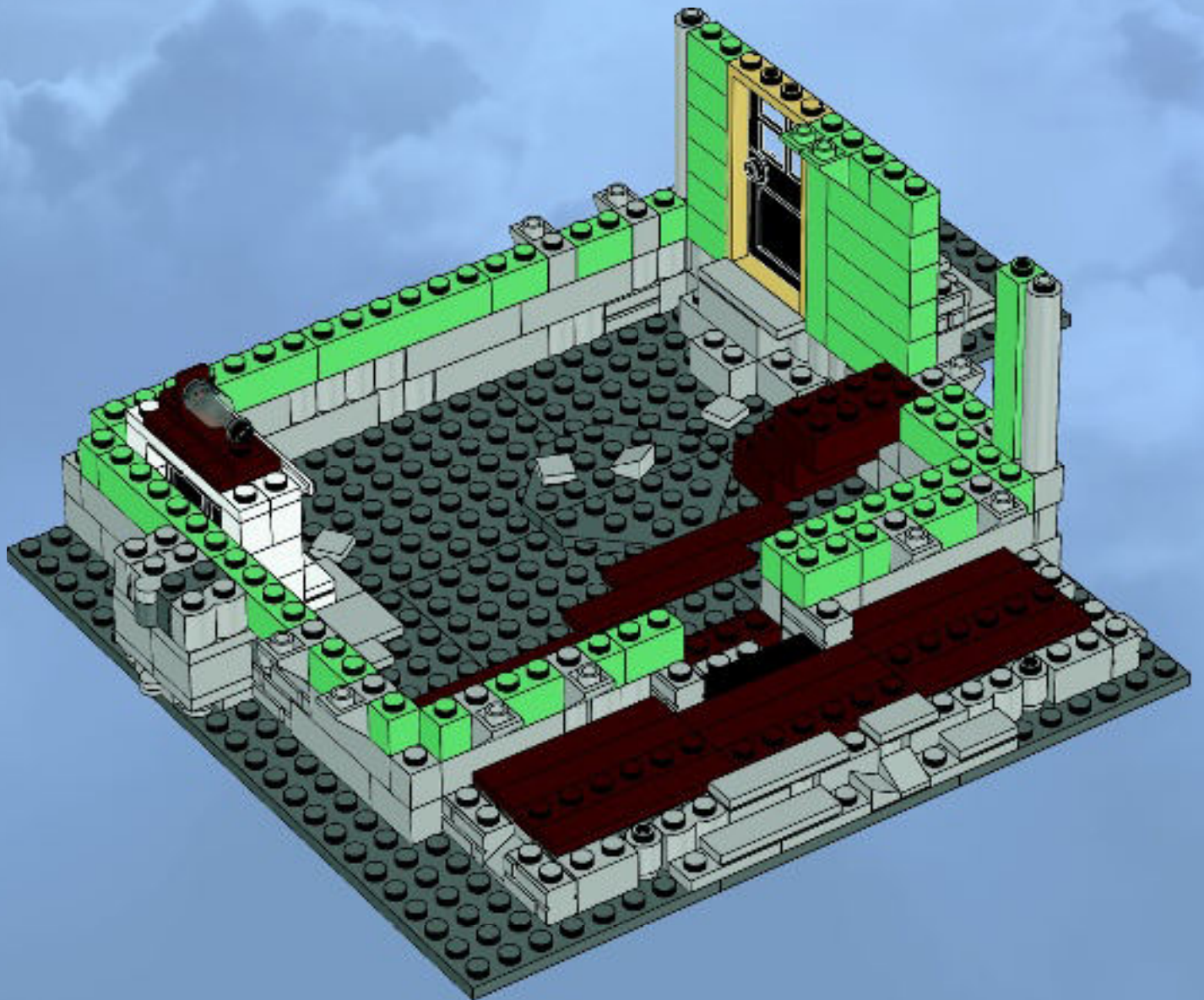



1x

2x

1x

# 3



1x

# 1

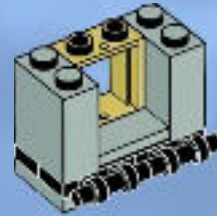

1x



2x

# 2



1x



1x



1x



1x

# 4

## 1

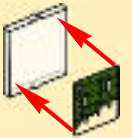

## 2

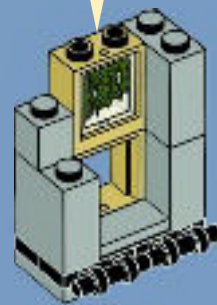



1x

5



1x



1x

6

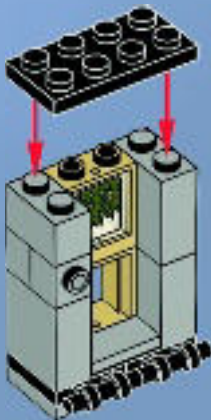

1x



2x

7



2x



1x

8





31

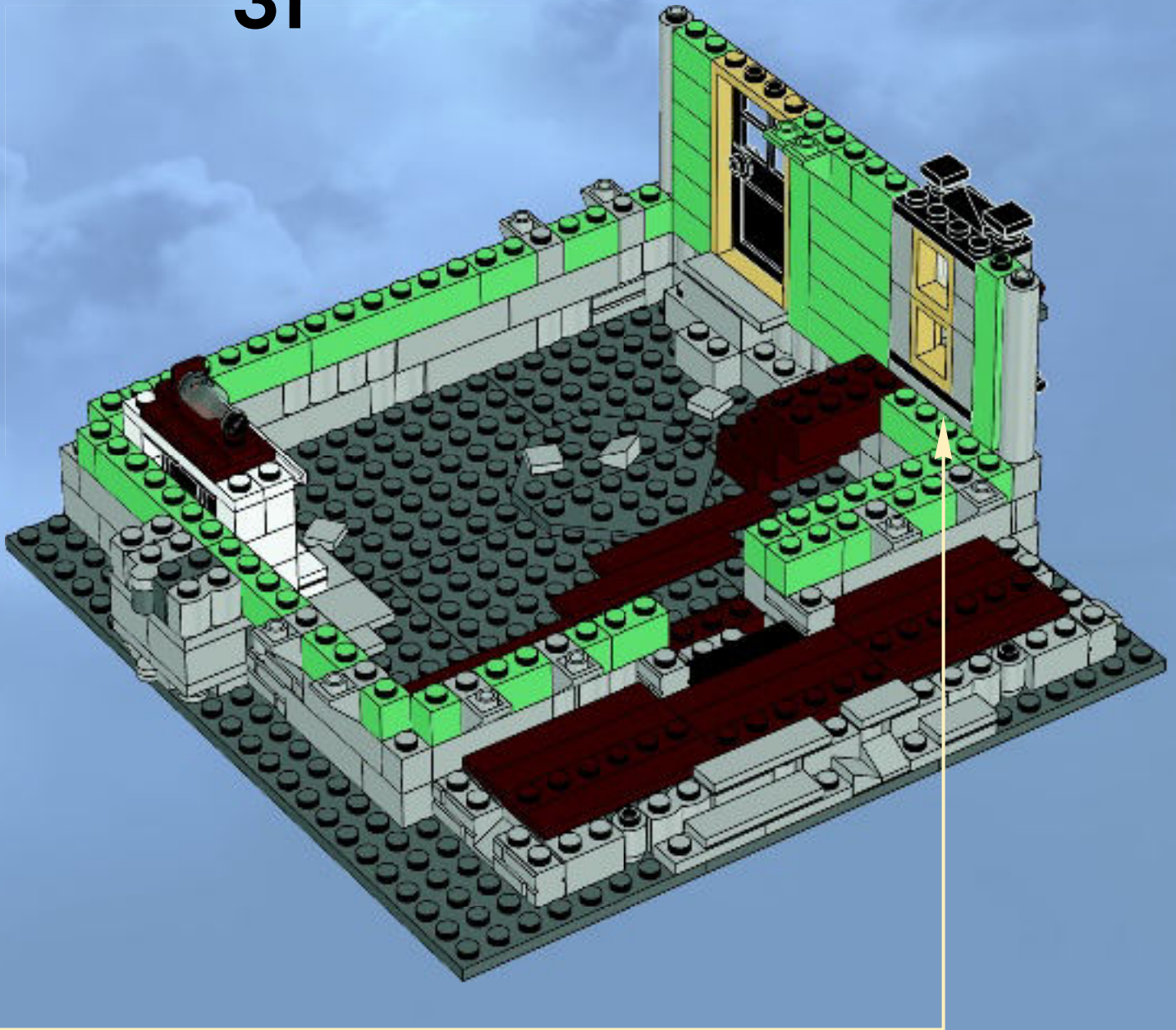

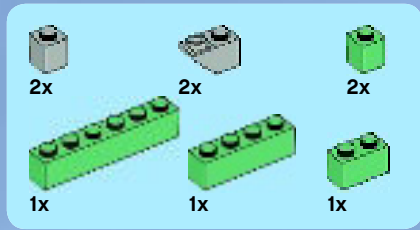

# 32

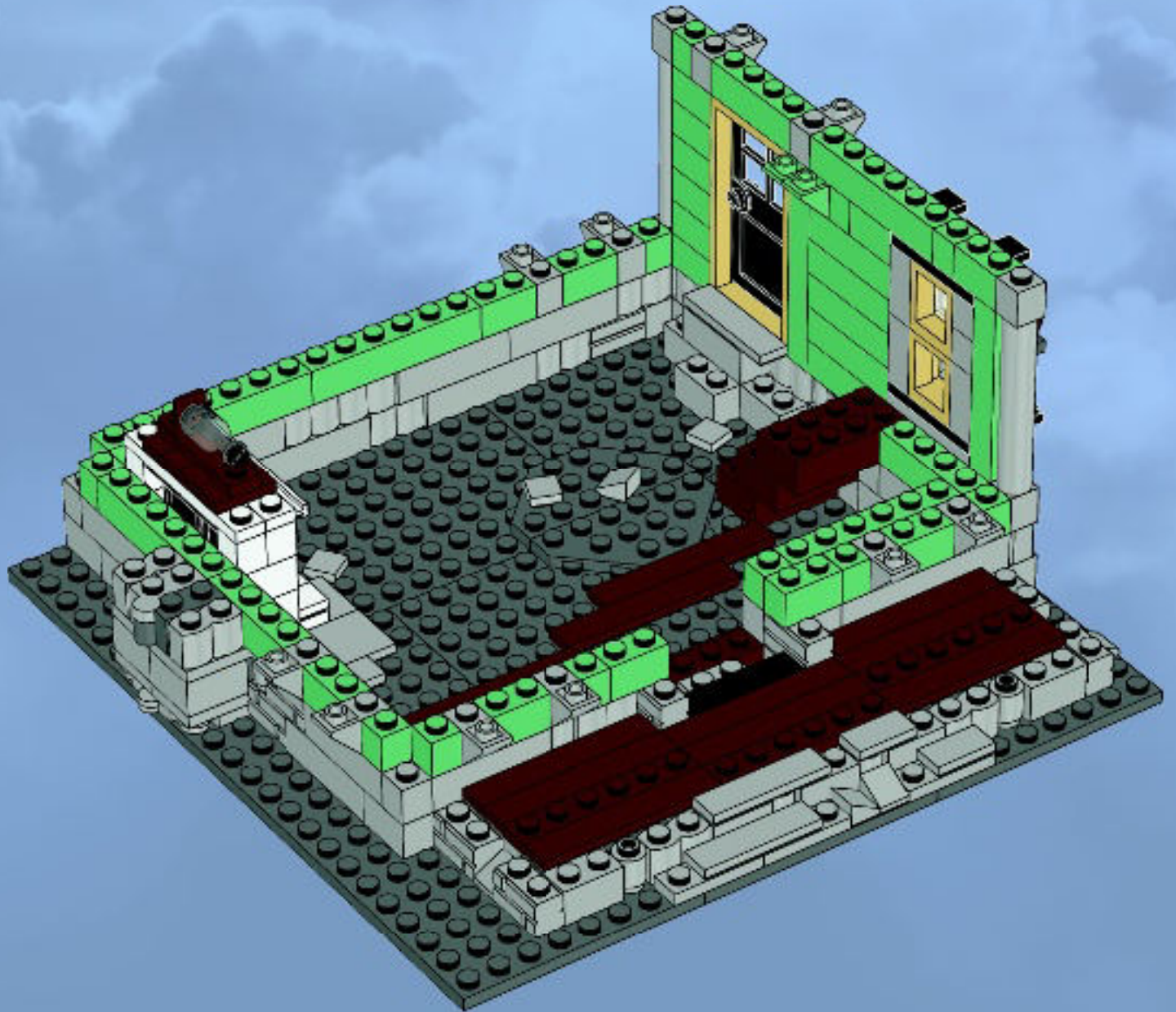



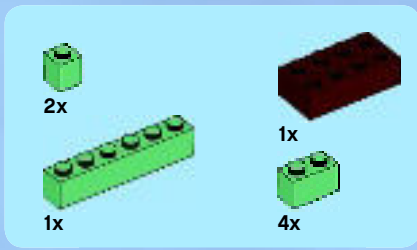

33

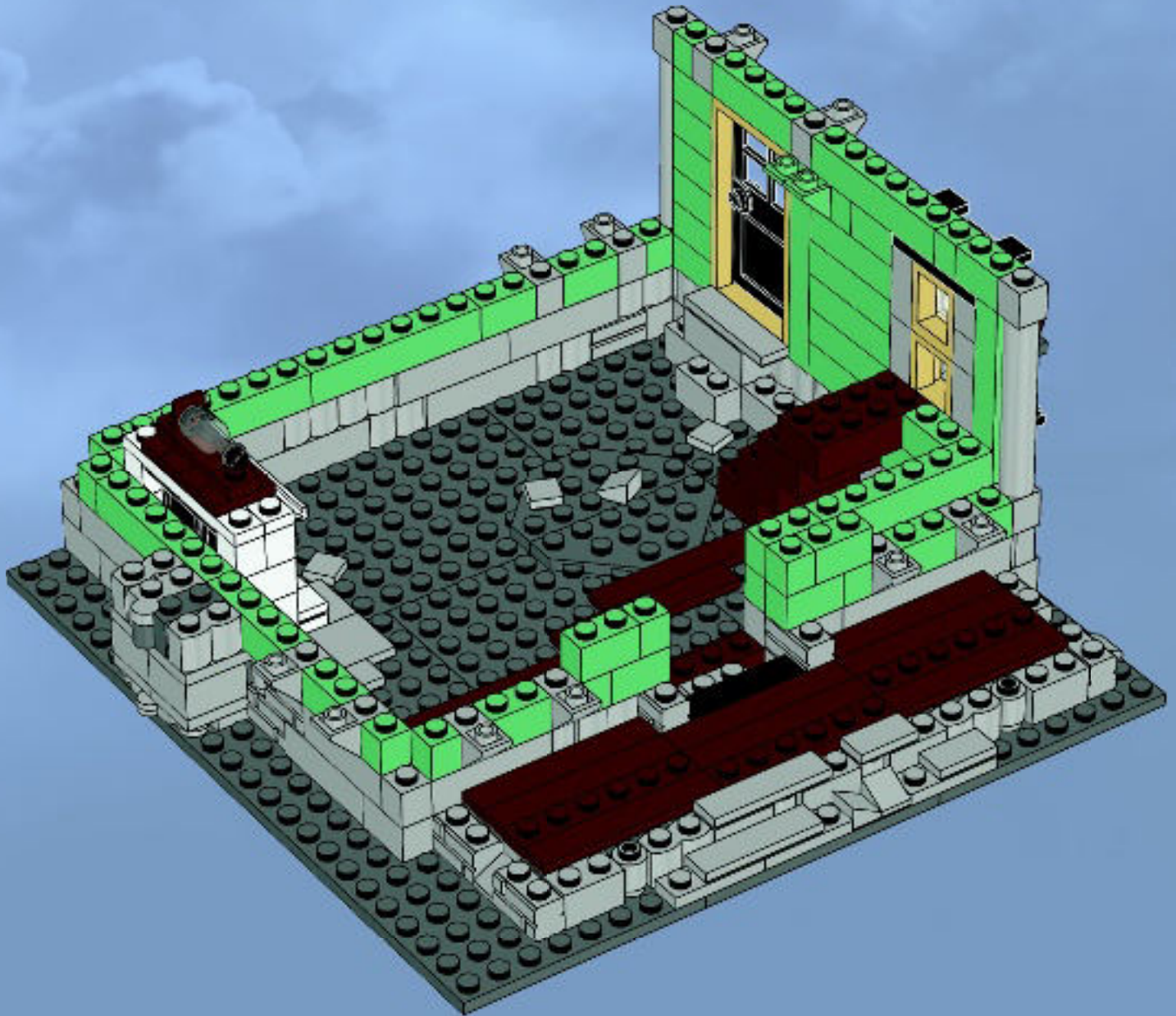



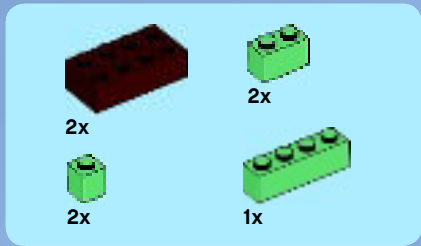

# 34

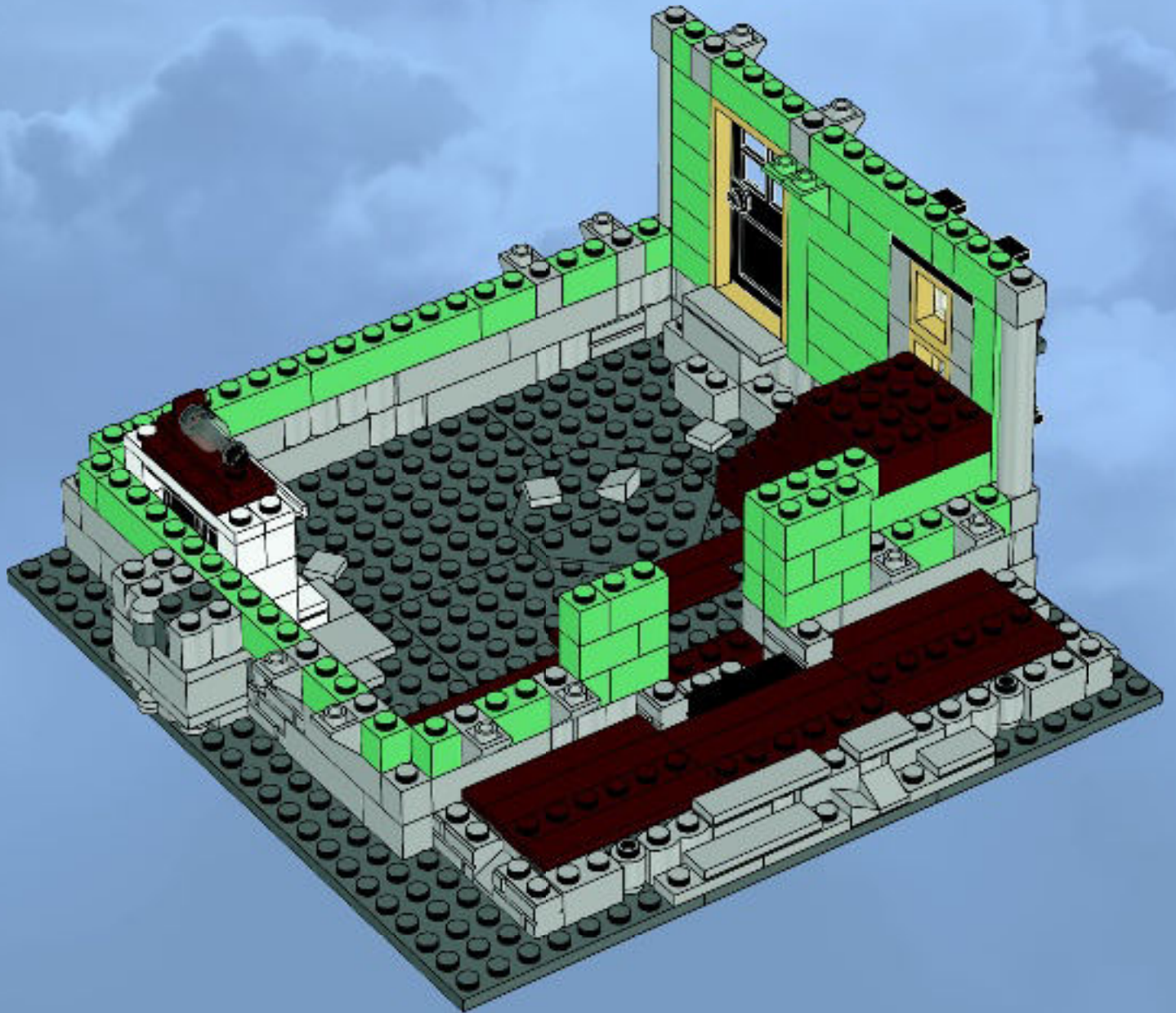



# 35

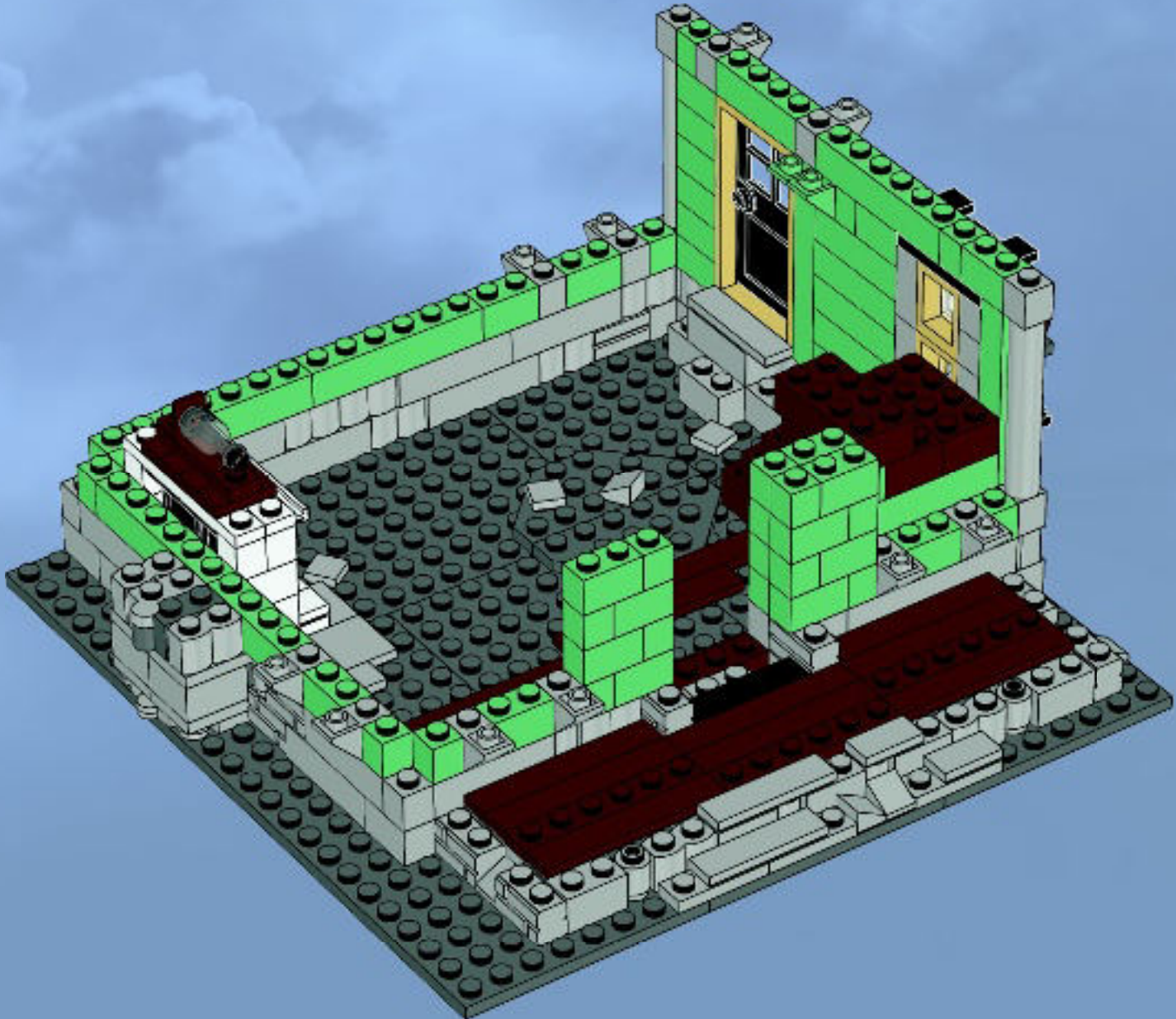



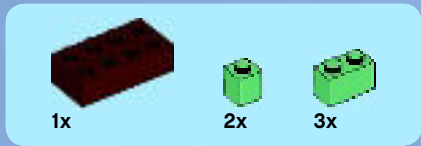

# 36

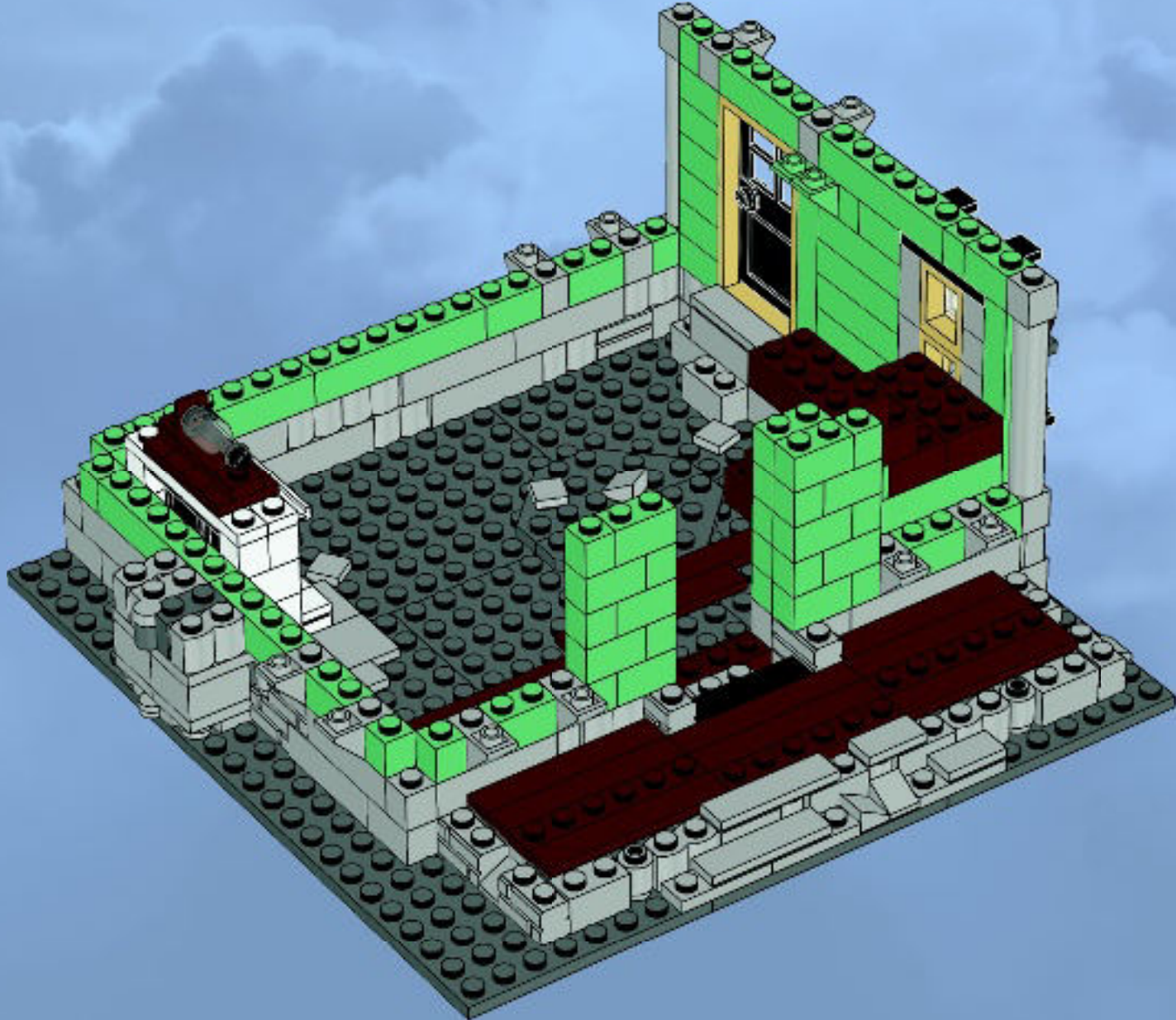





37

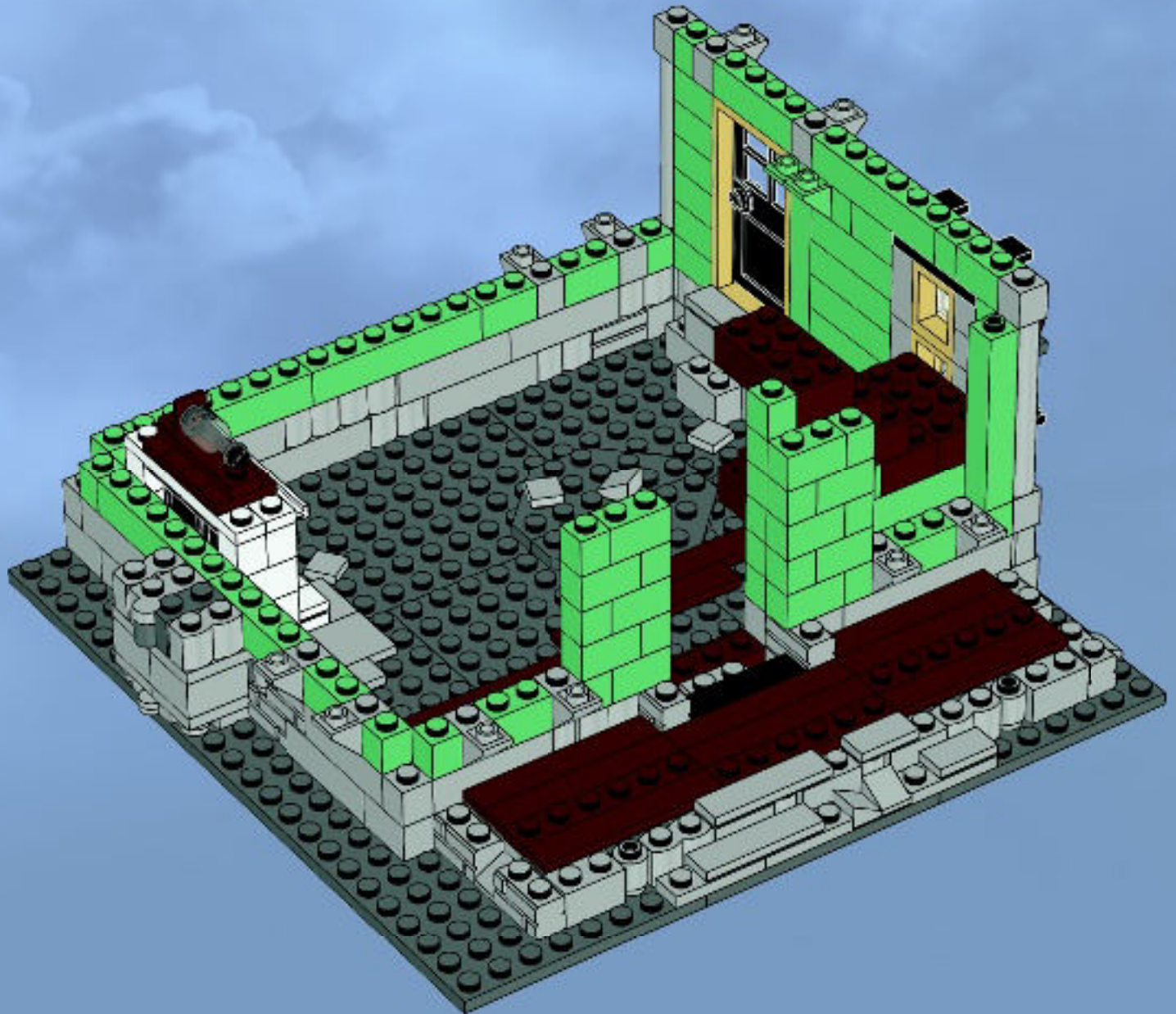



1x

1

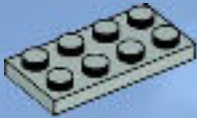

1x



2x

2



1x



2x



1x

3

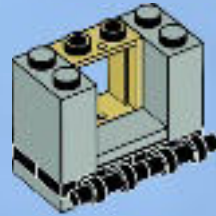

1x



1x

4

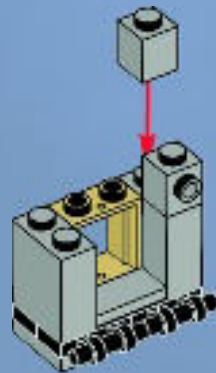



1x



1x

5

1

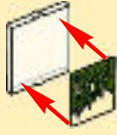

2



1x



1x



1x

6

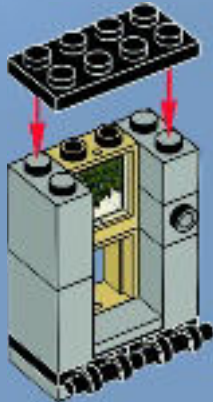

1x



2x

7

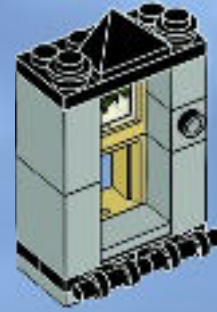

2x



1x

8

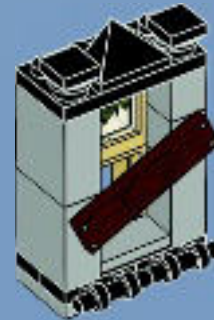



38

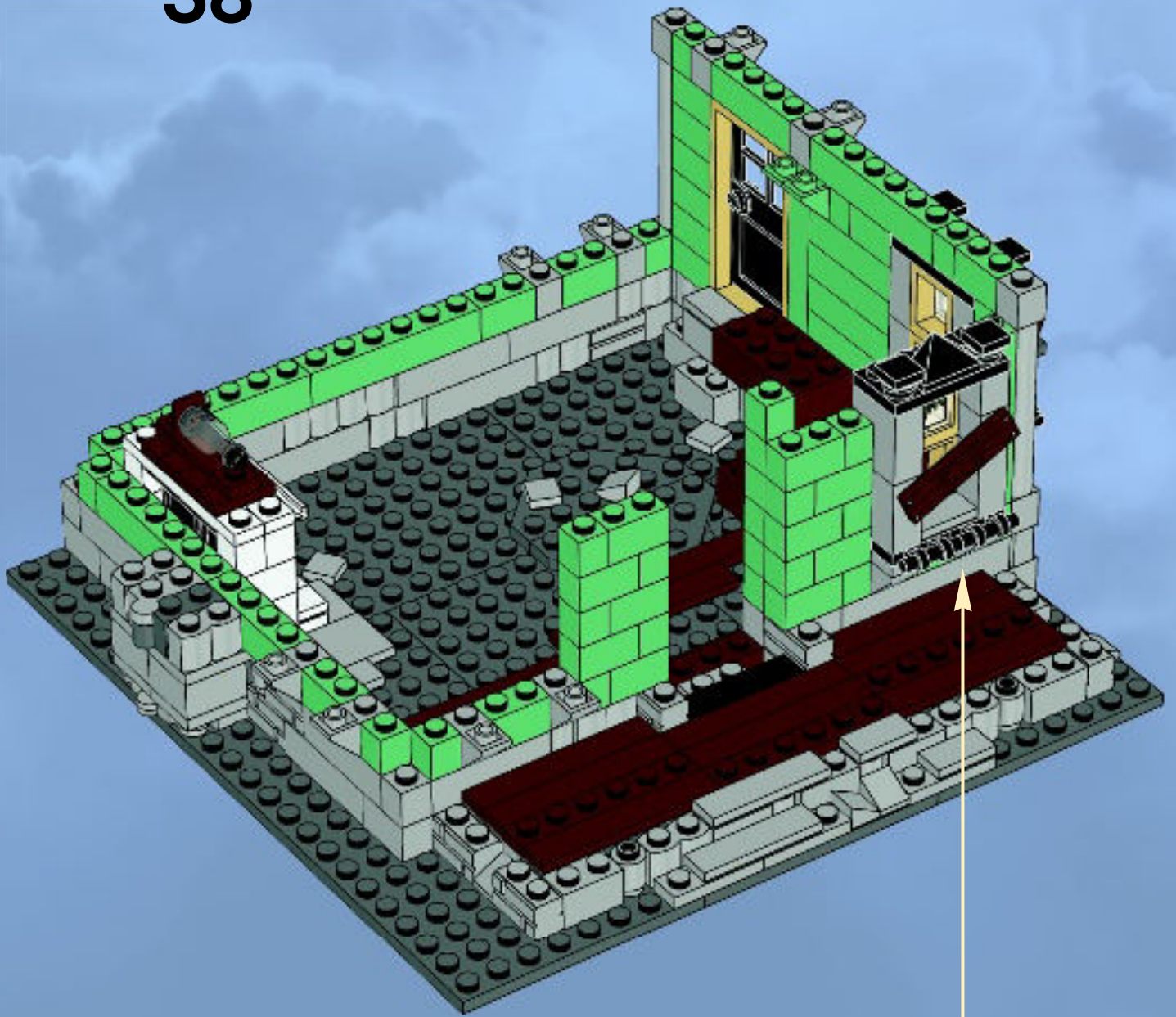

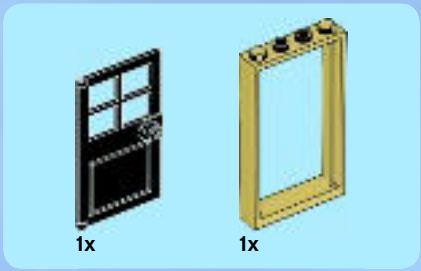

39

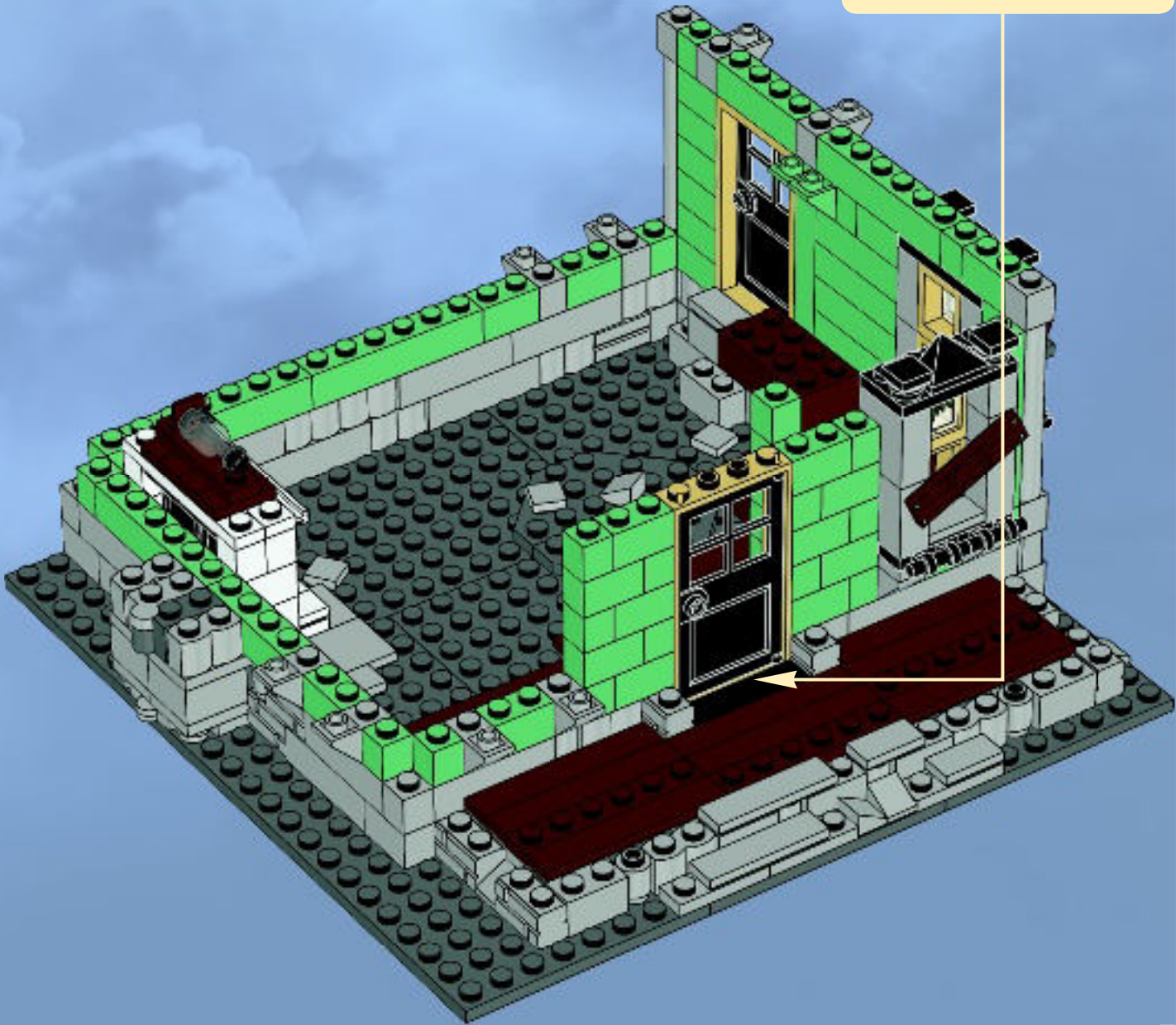
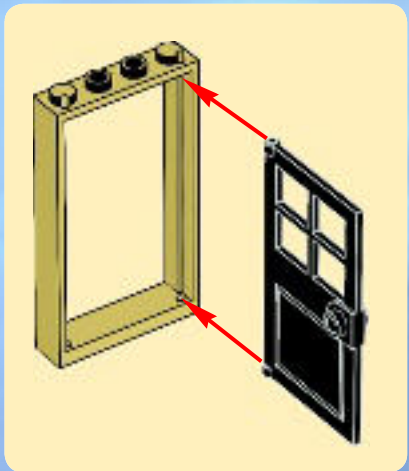



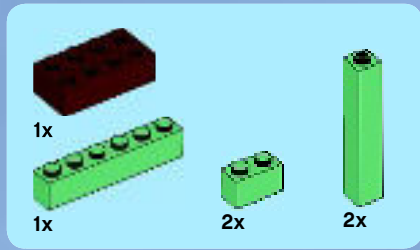

40

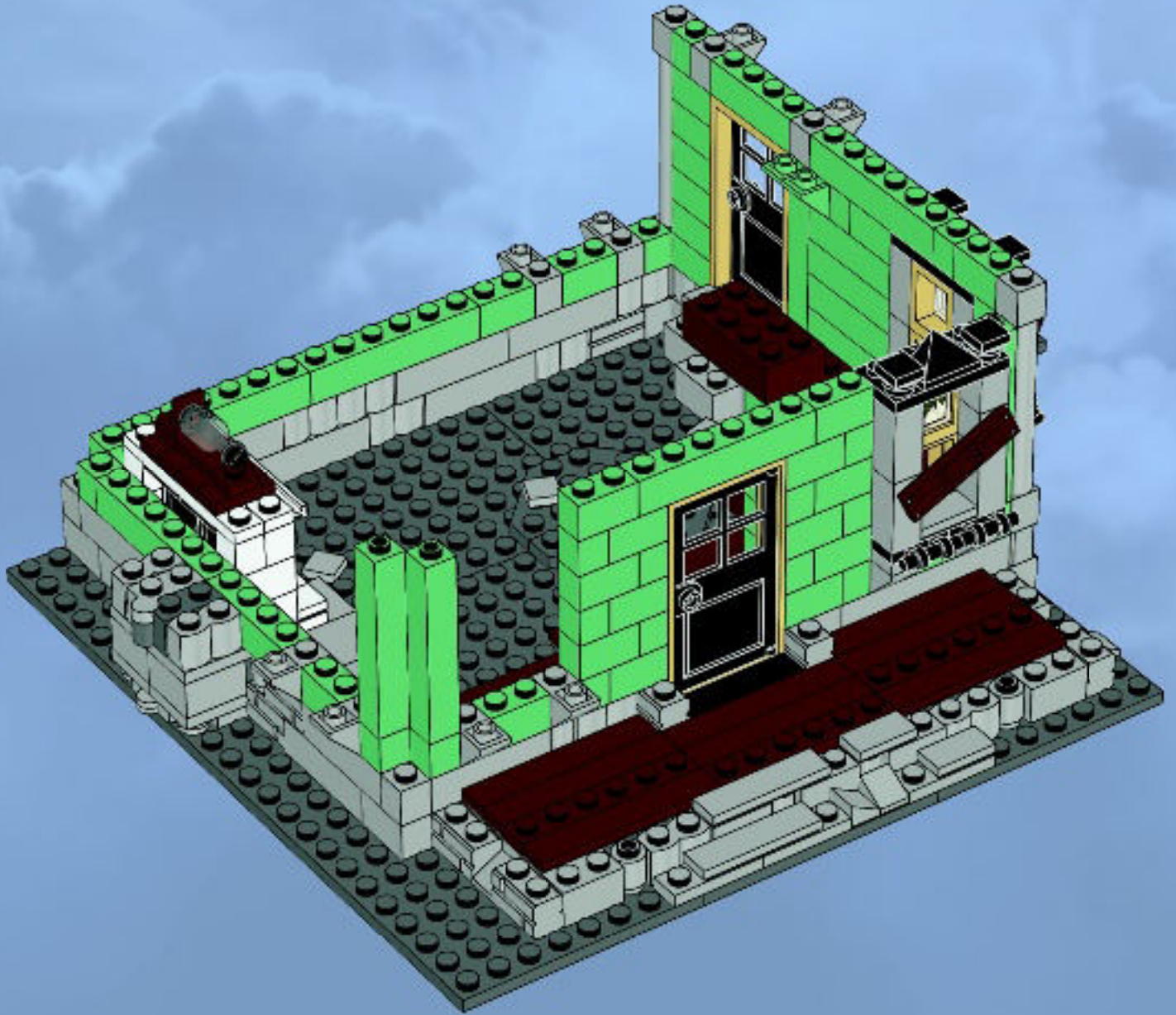





1x

1

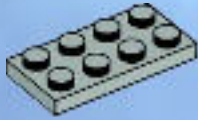

1x



2x

2



1x



2x

3

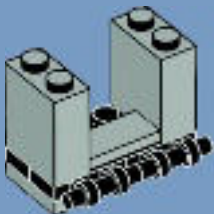

1x



1x



1x

4

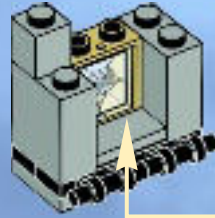

1x



1x



1x

5

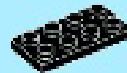
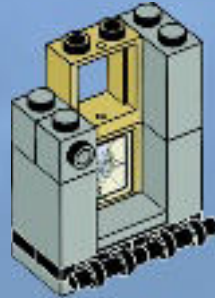

1x



1x

6

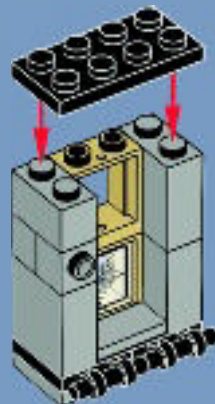



1x



2x

7



2x



1x

8



41

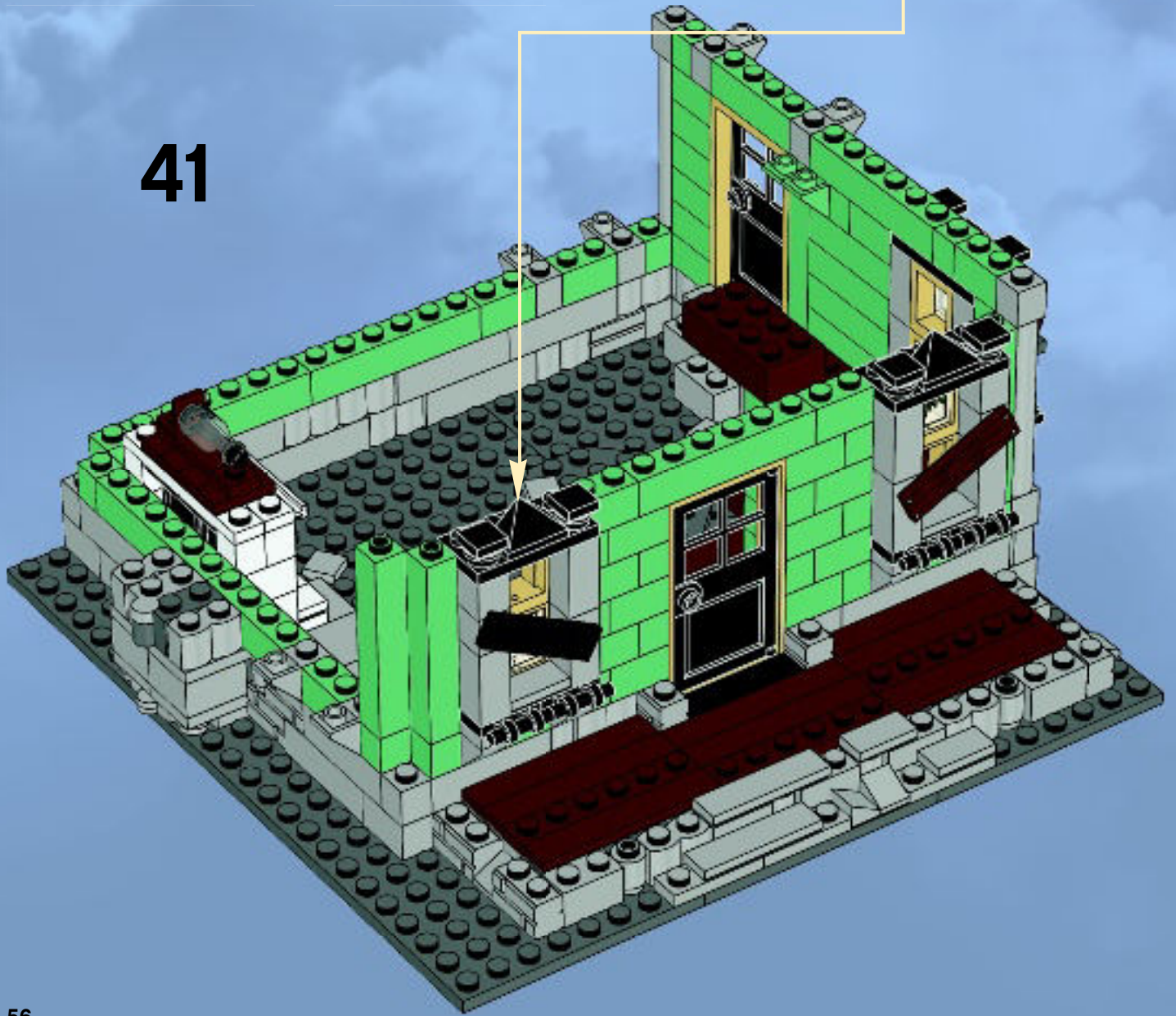



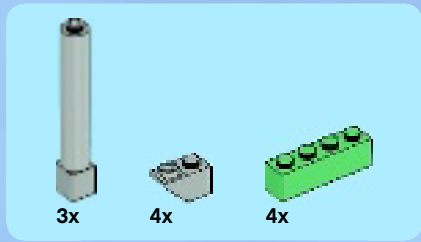

42

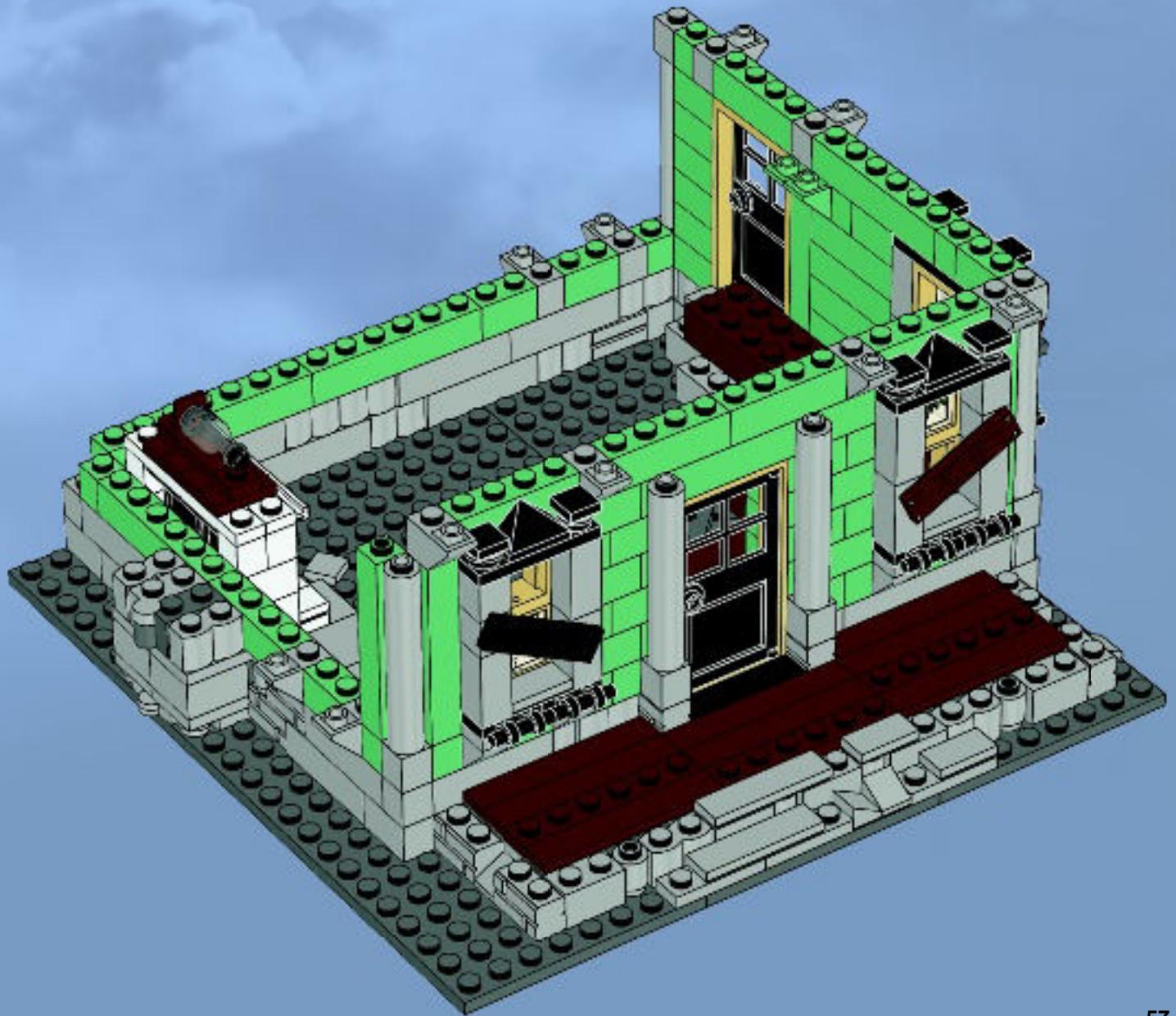





1x

1

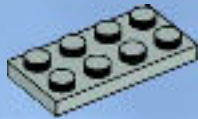

1x



2x

2



1x



2x

3

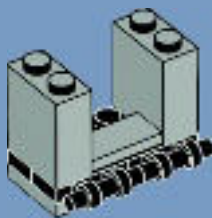

1x



1x



1x

4

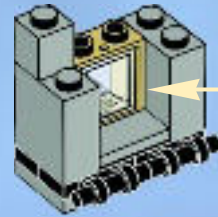

1

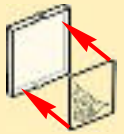

2



1x



1x



1x

5

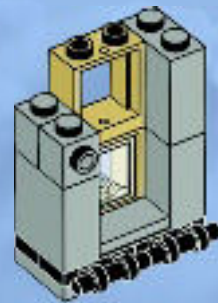

1x



1x

6

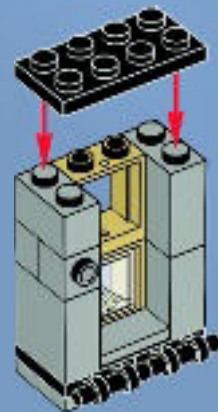



1x



2x

7

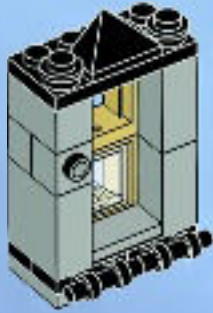

2x



1x

8

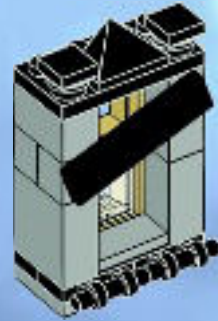

43

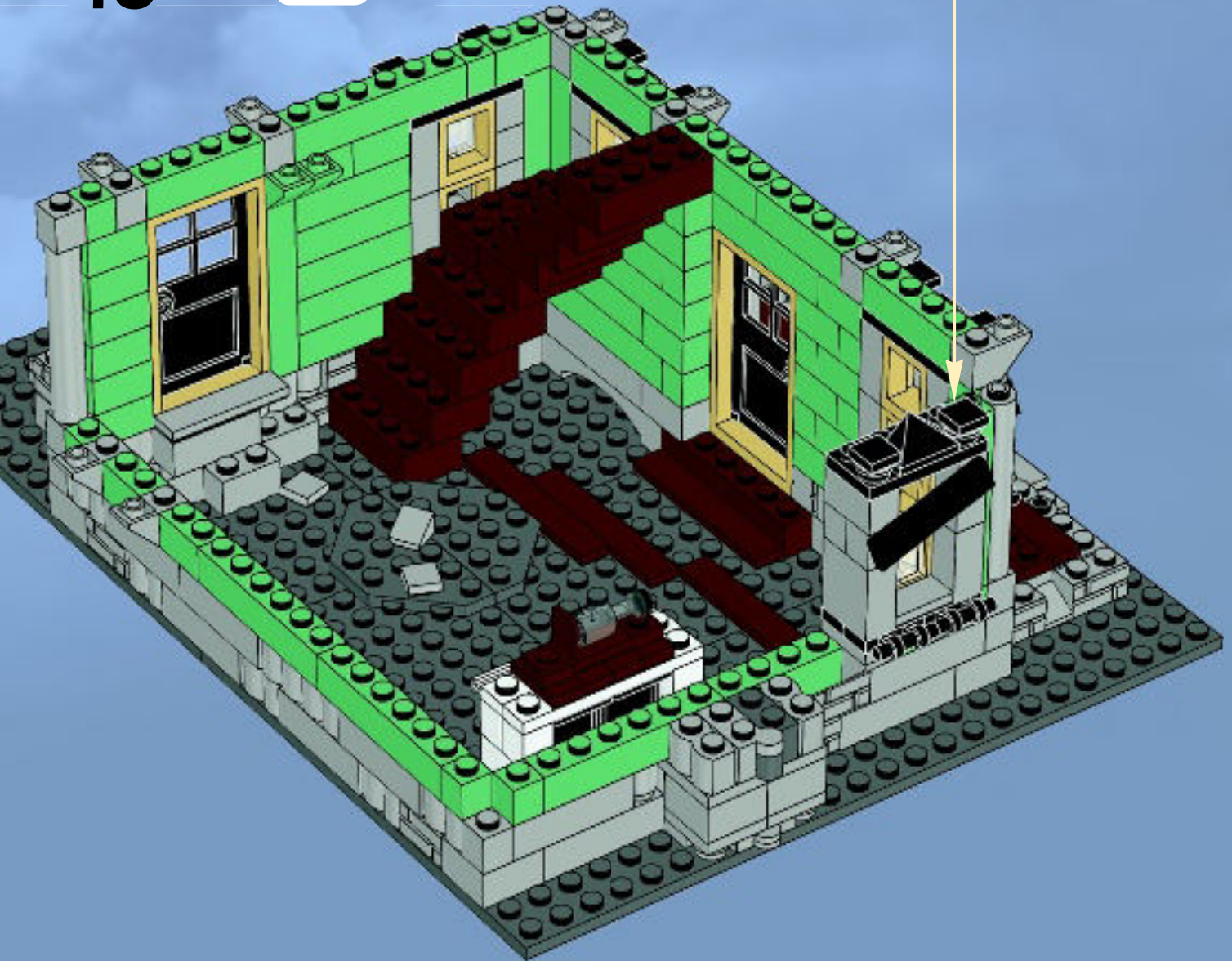



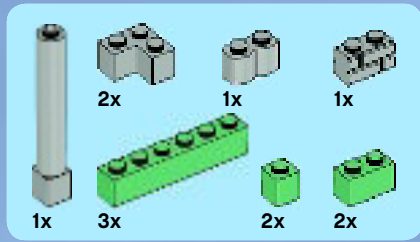

44

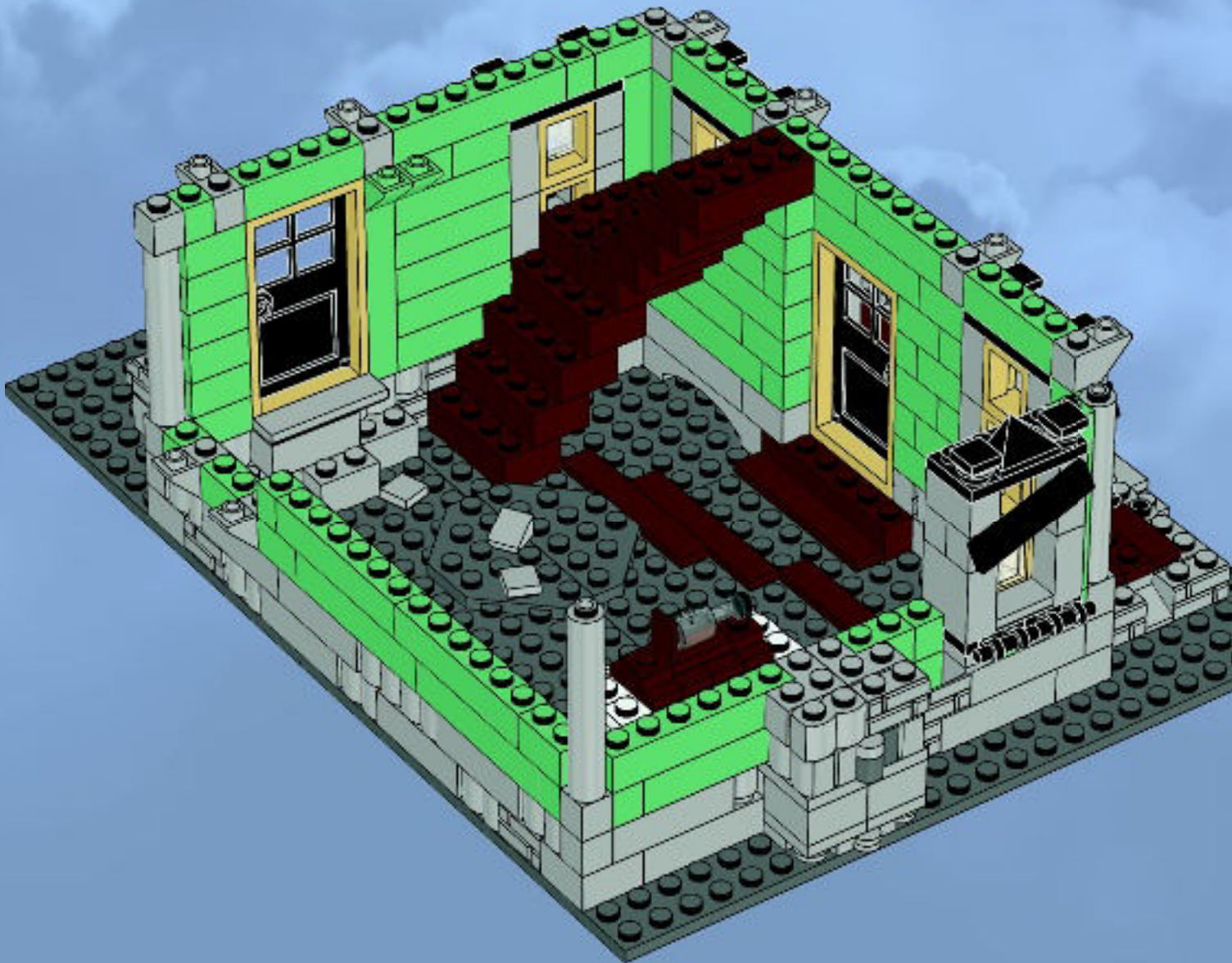



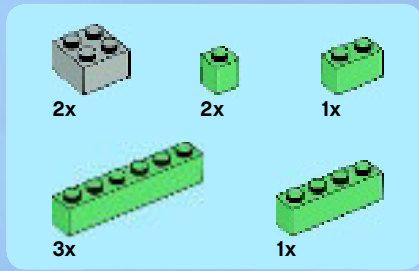

# 45

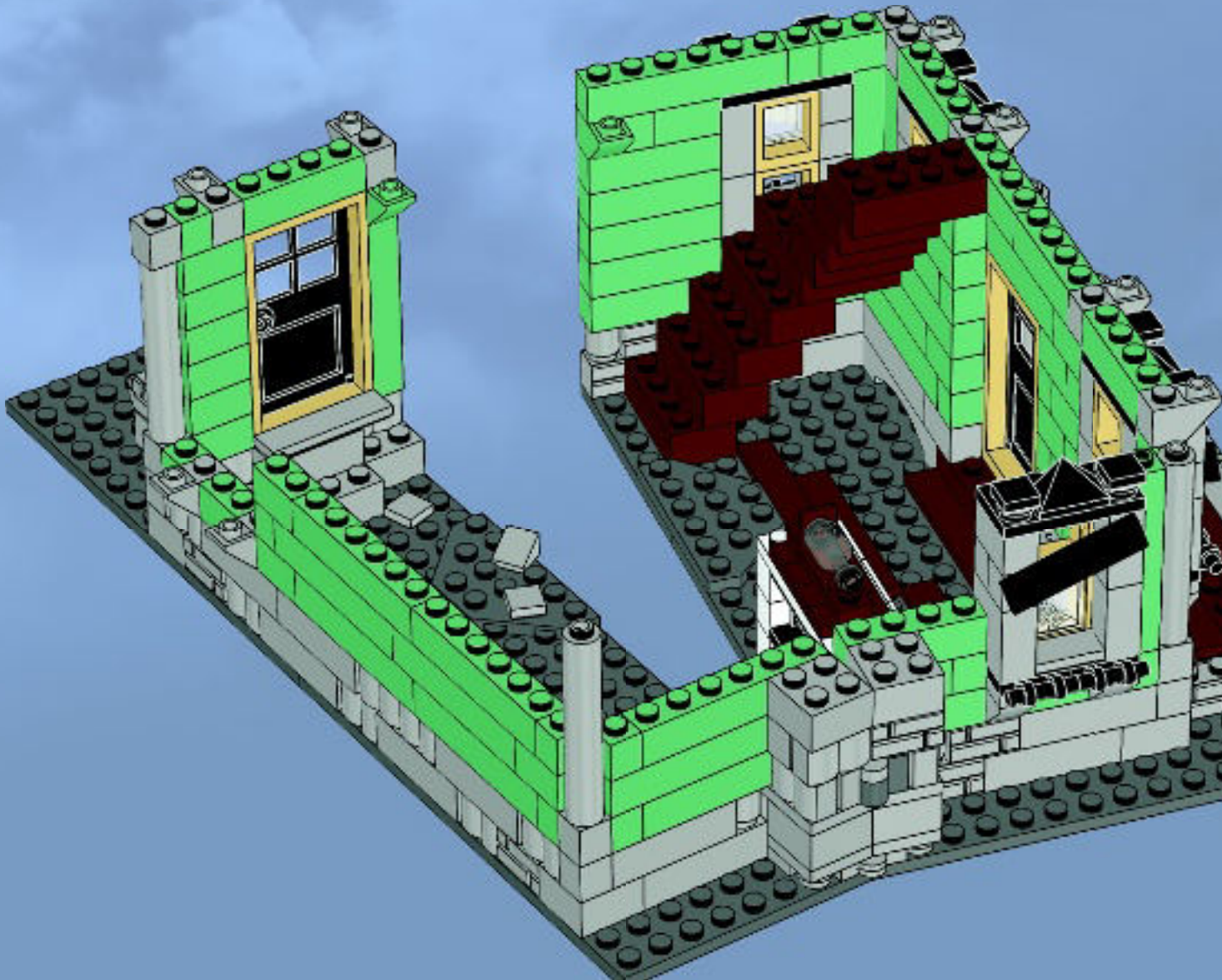

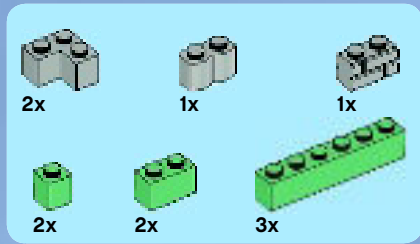

# 46

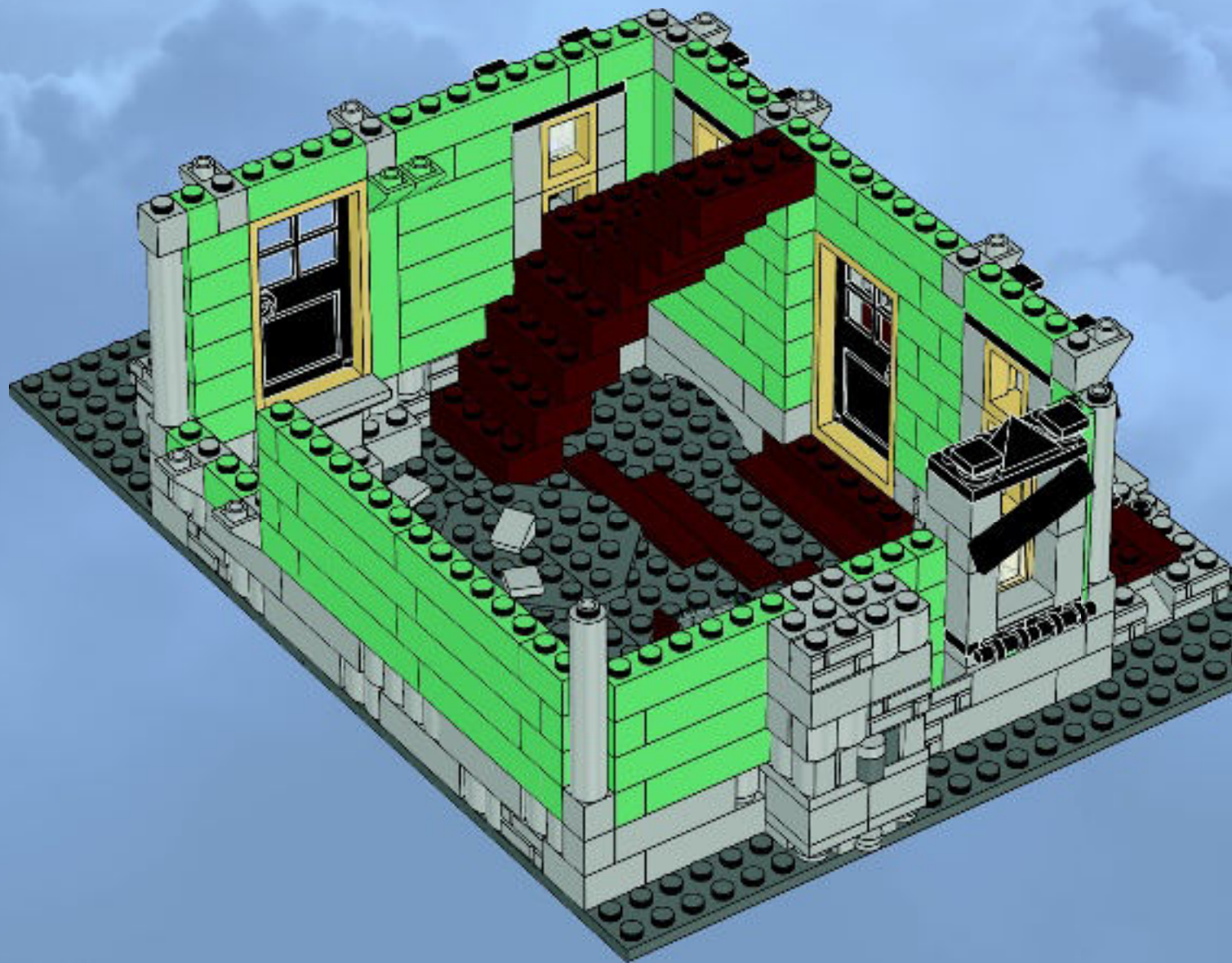



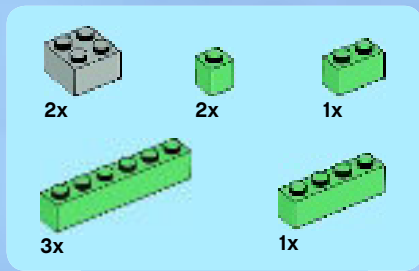

47

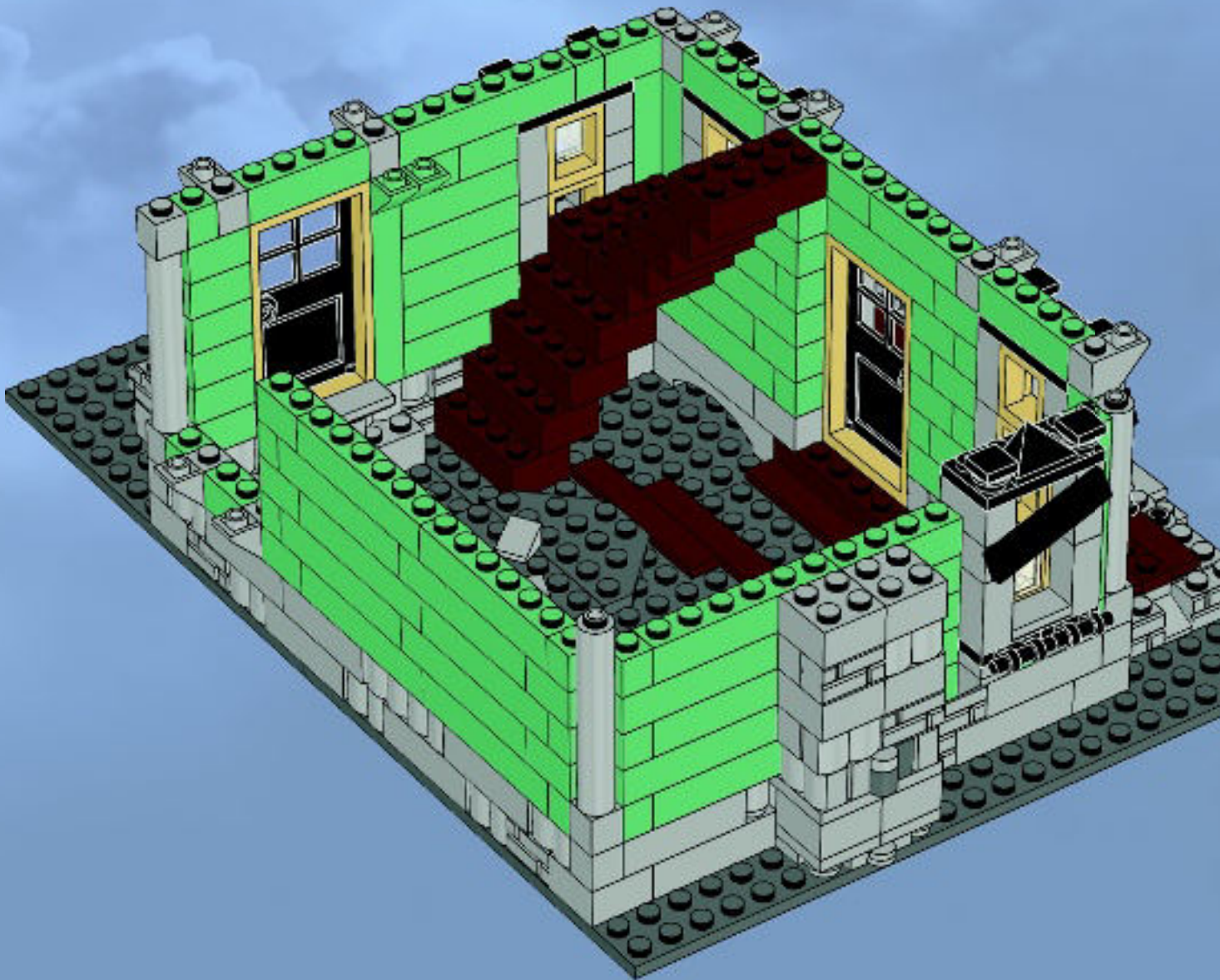



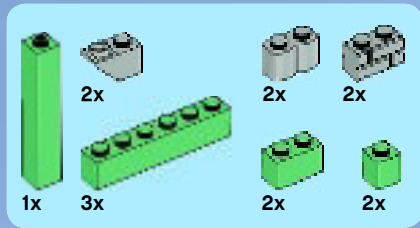

# 48

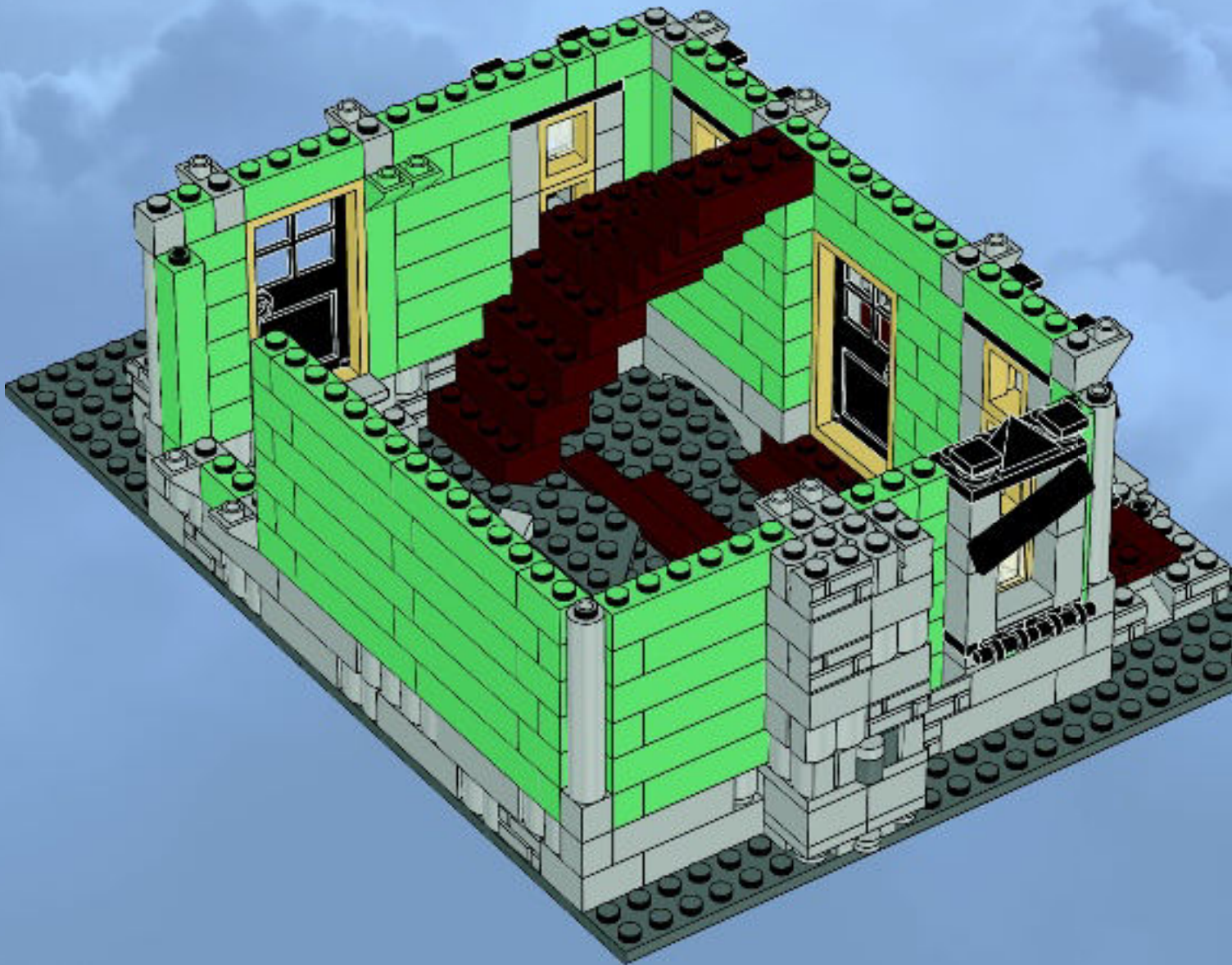

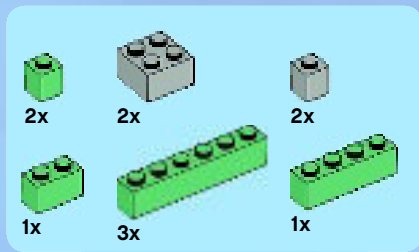

# 49

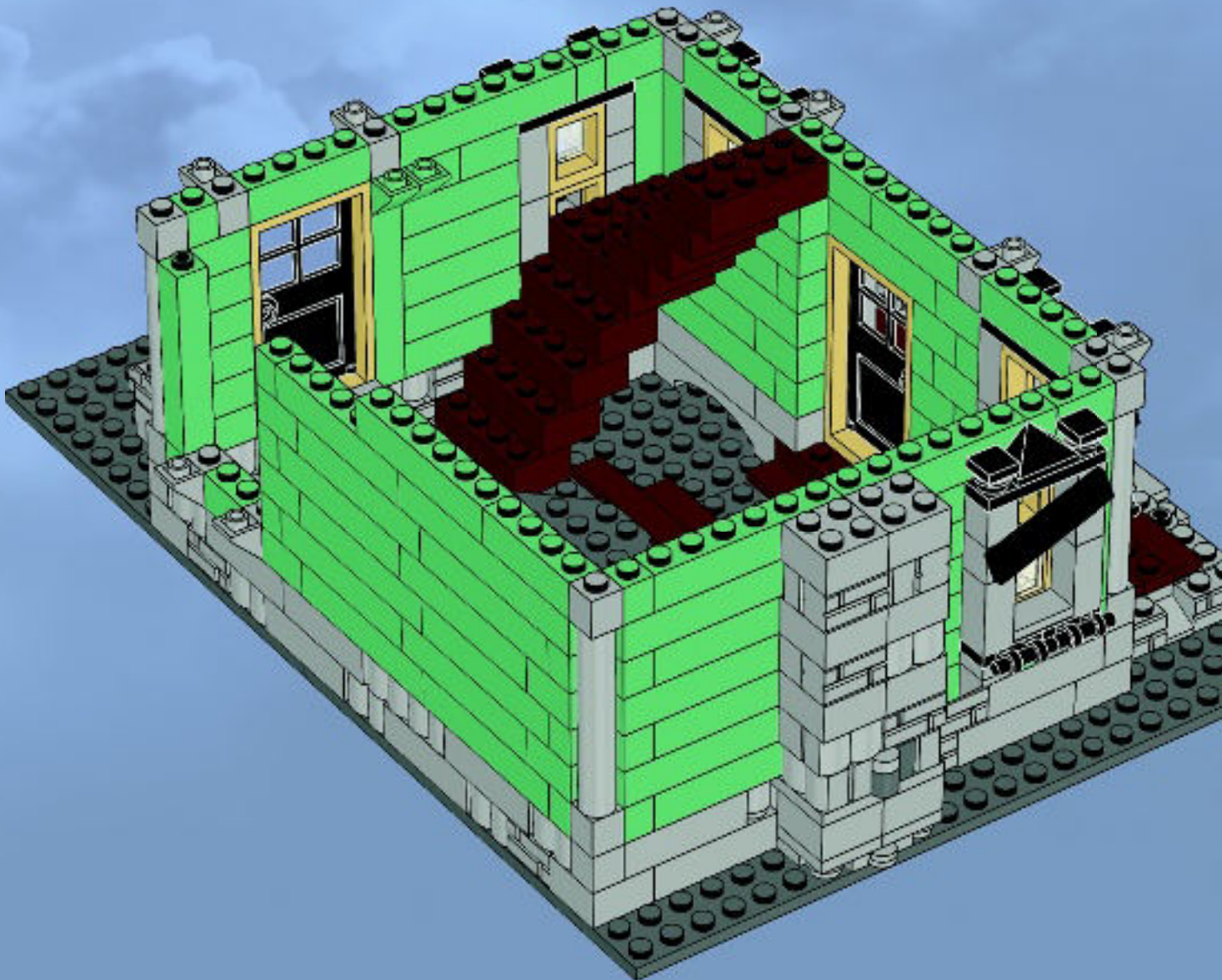





1x

1



1x



2x

2



1x



2x



1x

3

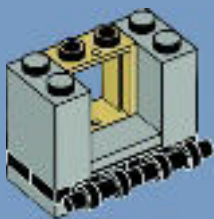

2x



1x

4

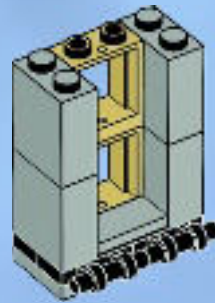

1x

5



1x



2x

6

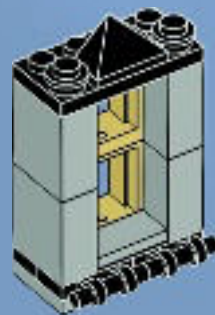



2x

7

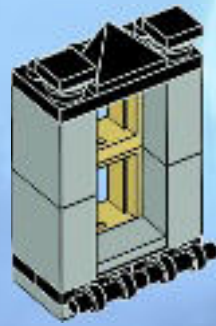

50

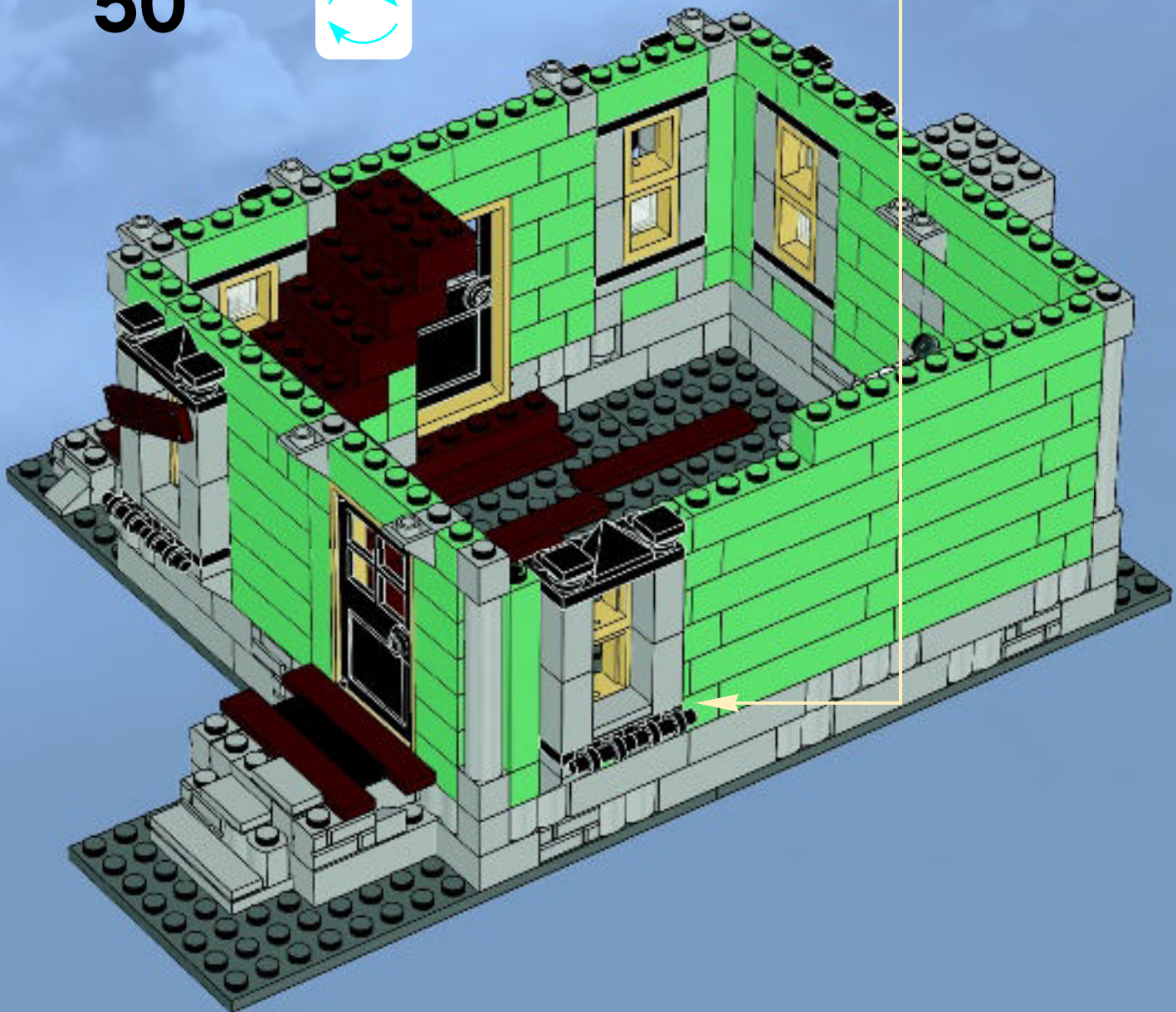



1x

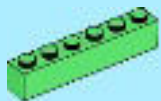

1x

# 51

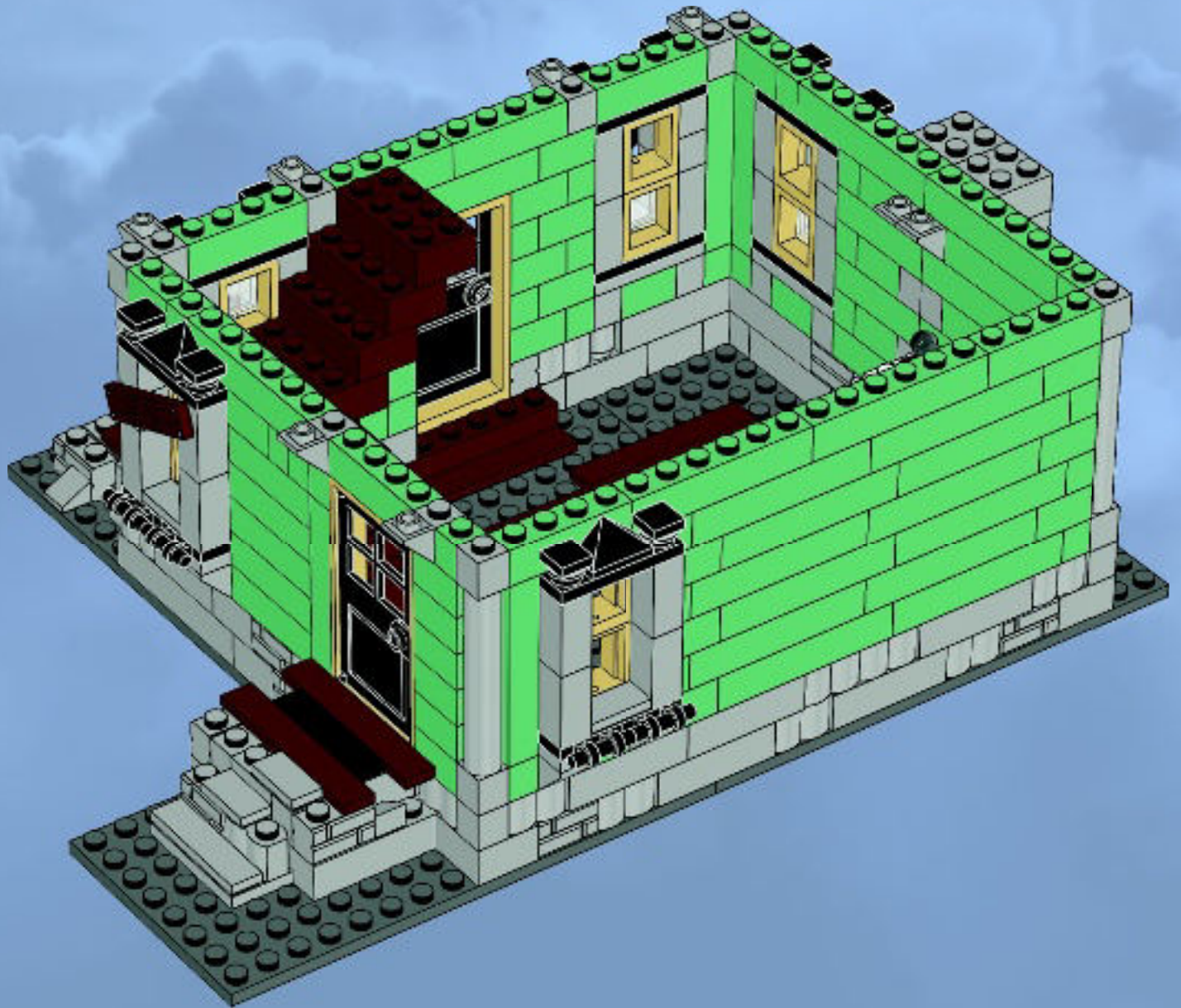



52

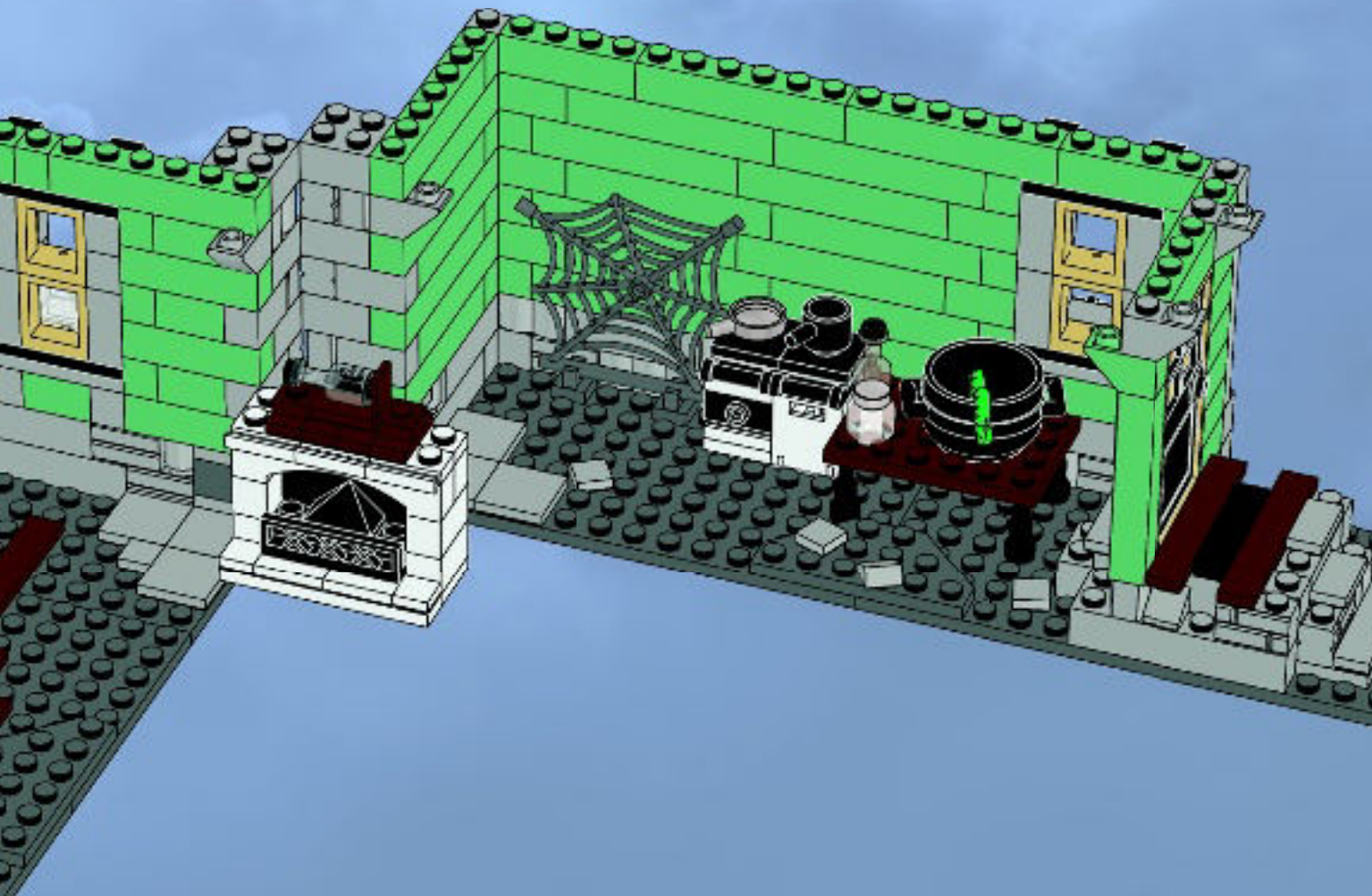



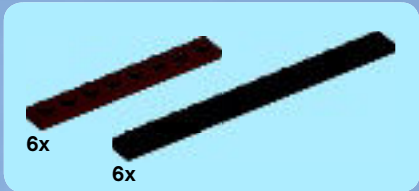

1

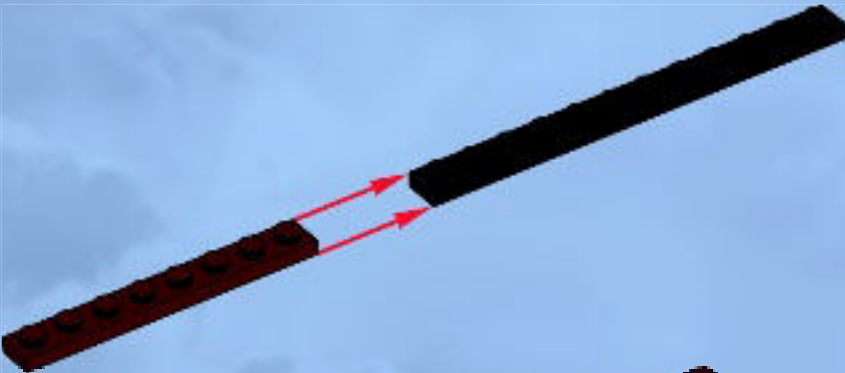

2

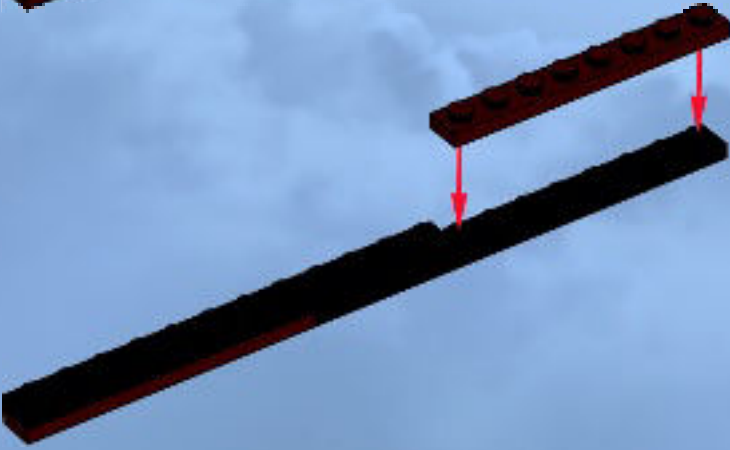

3



2x

53

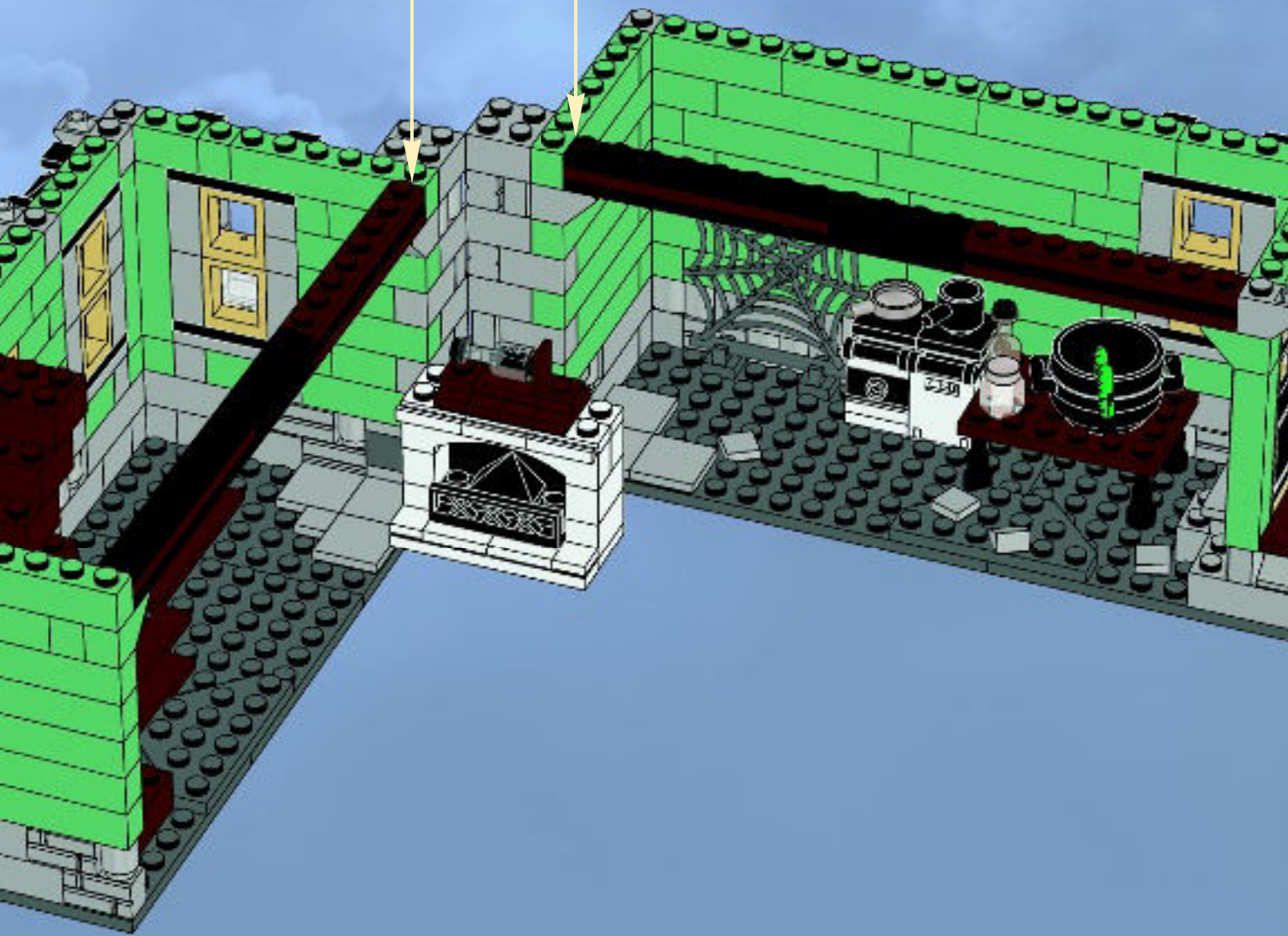

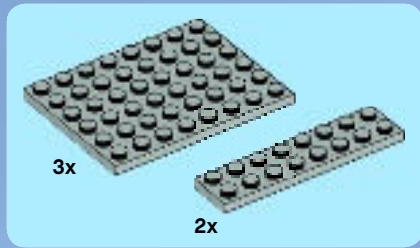

54

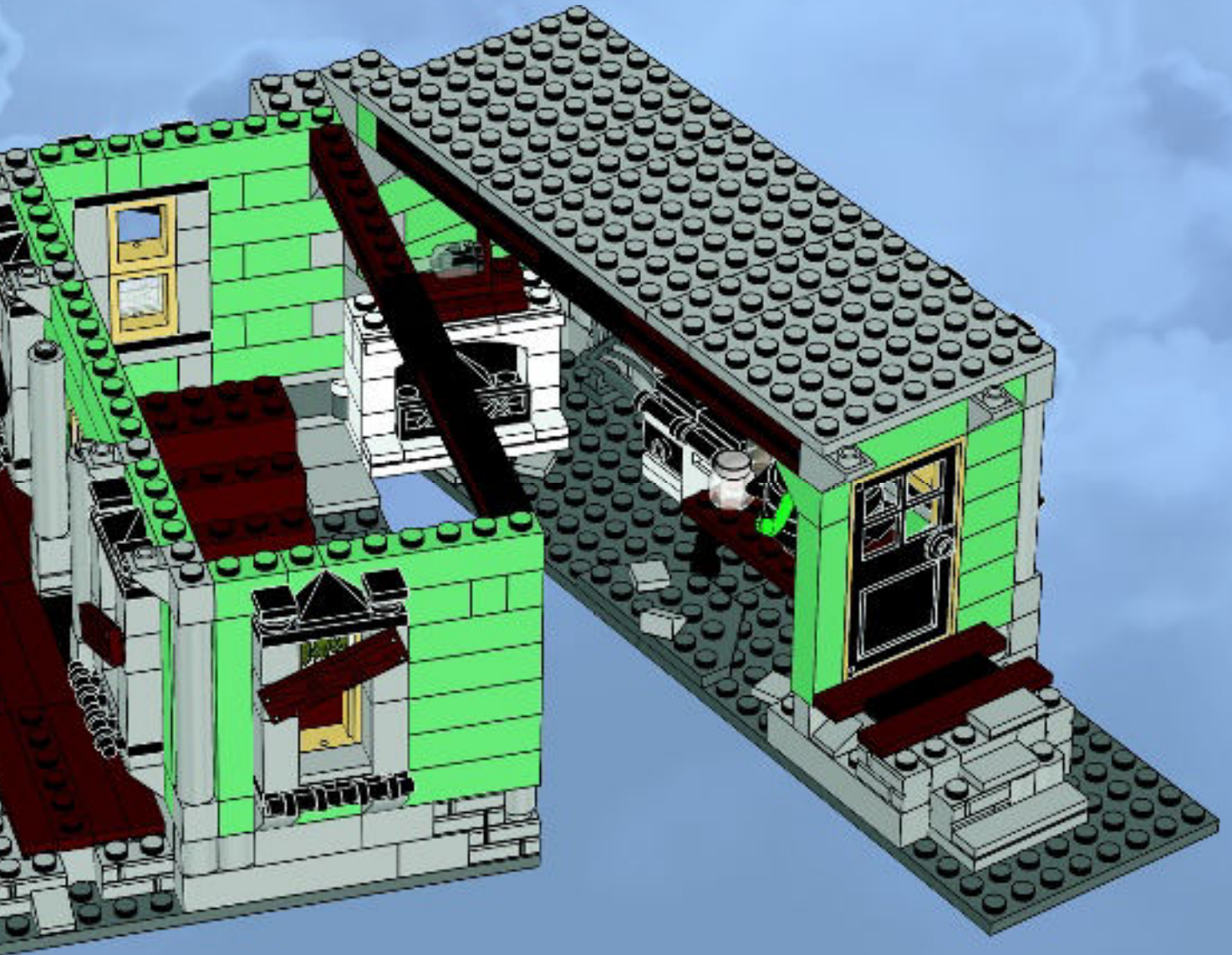



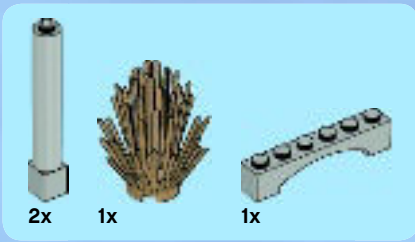

55

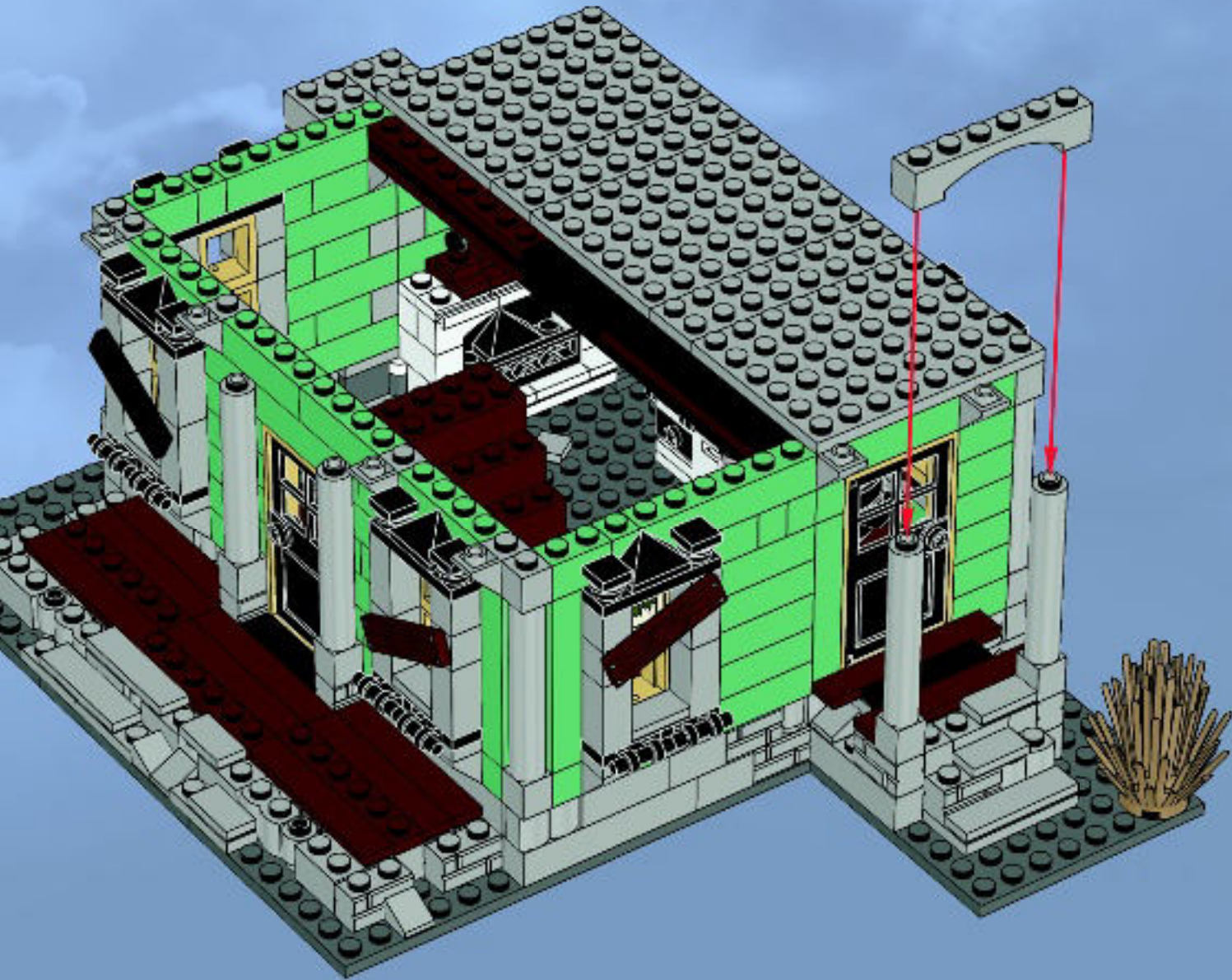



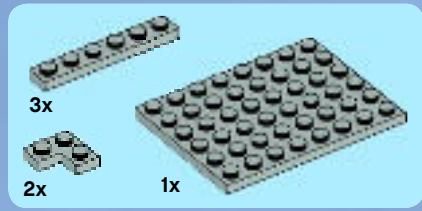

# 56

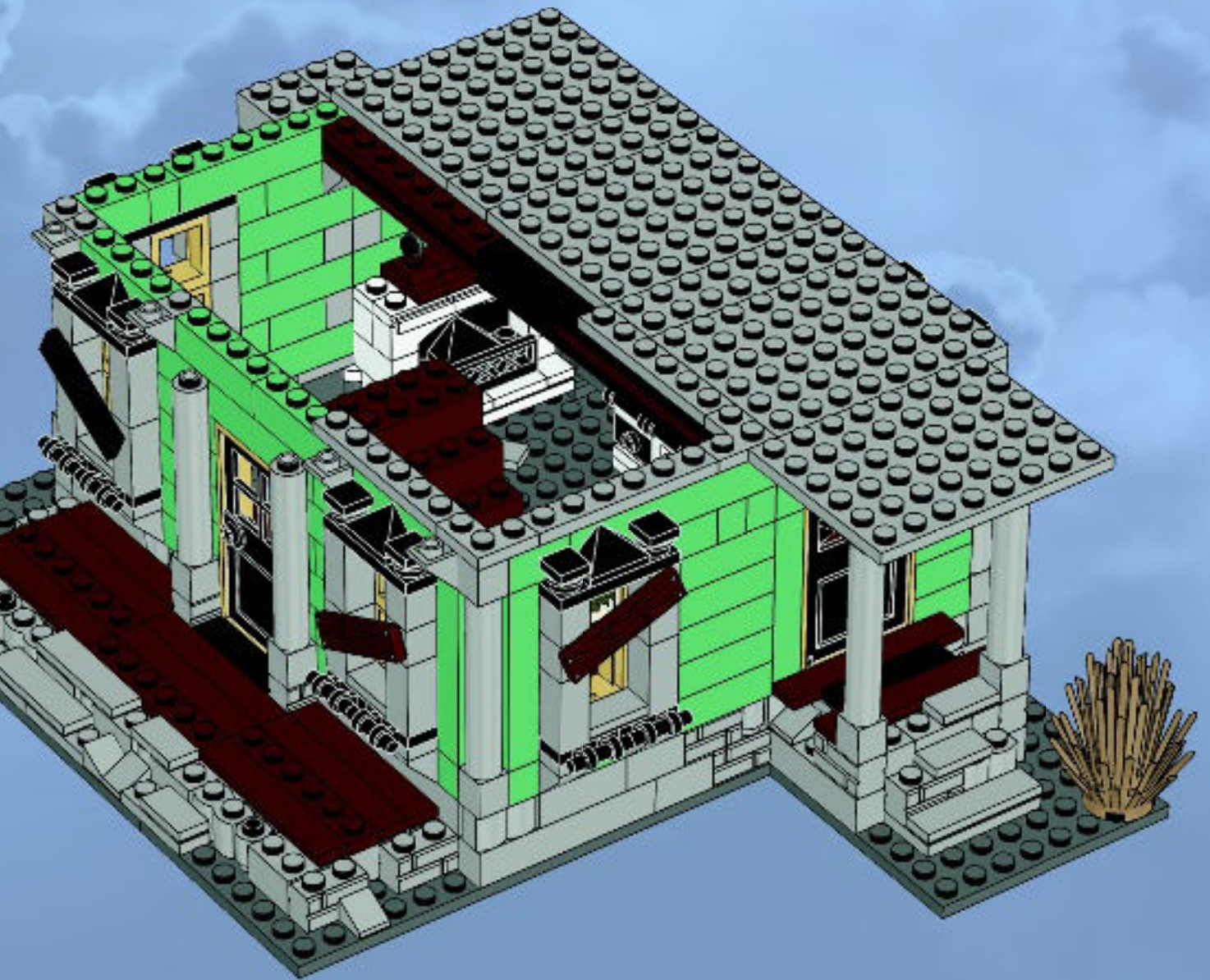



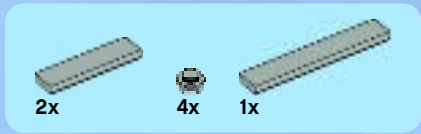

57

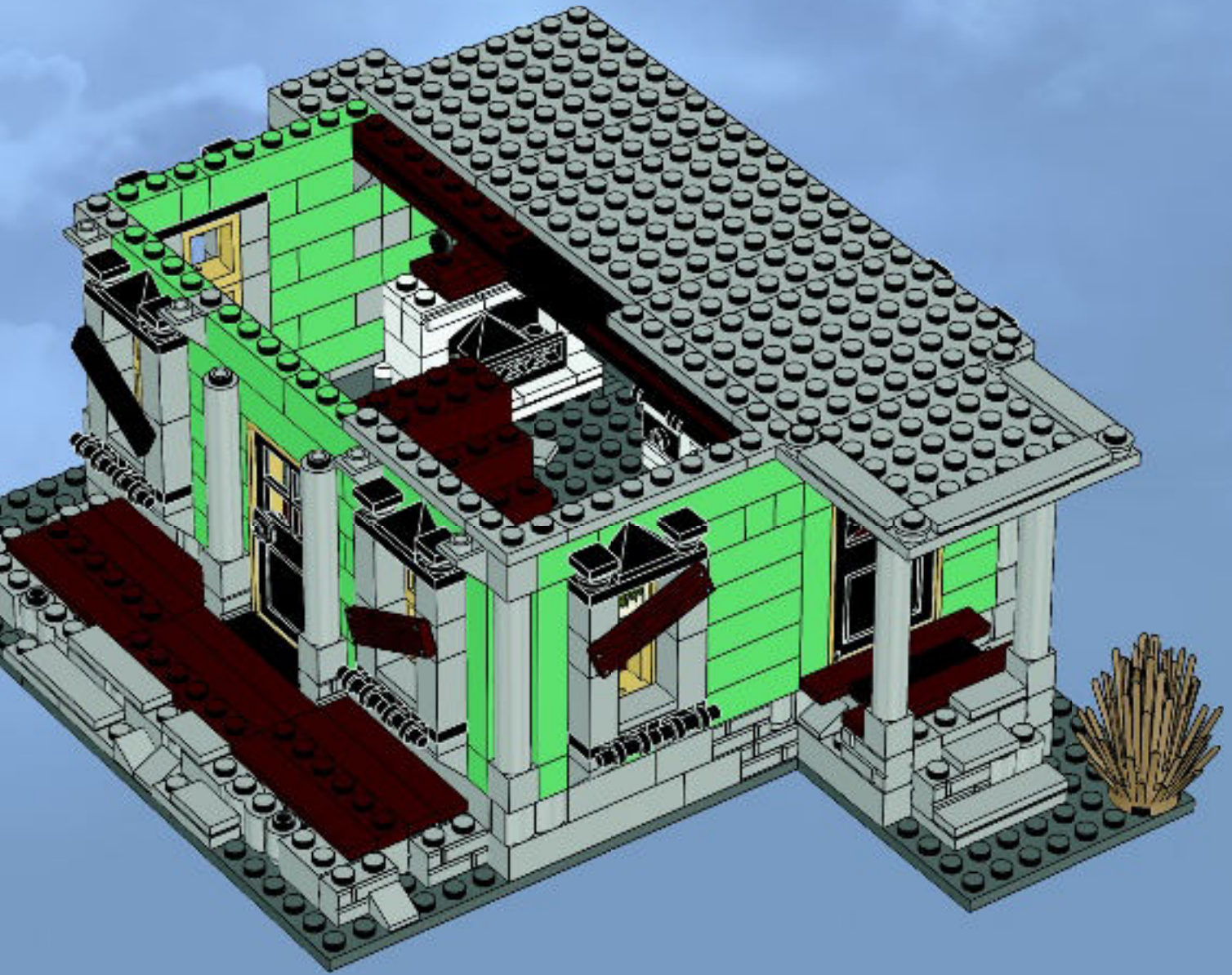



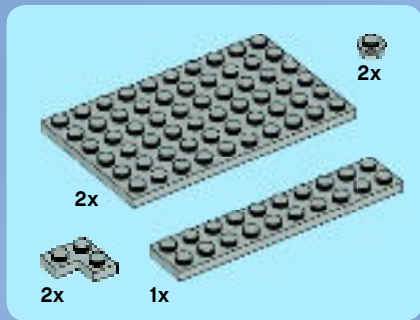

58

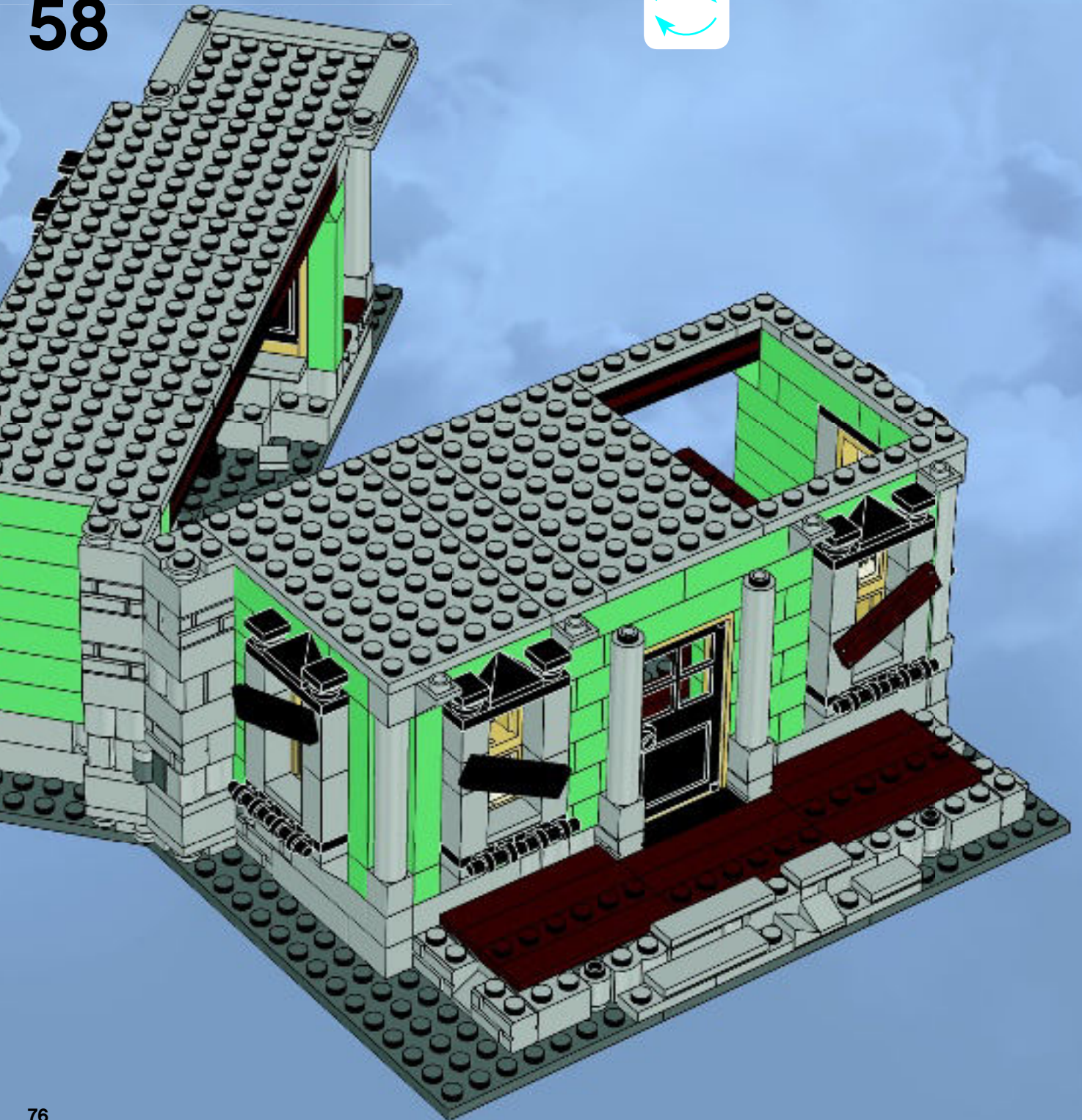





4x



4x

# 59

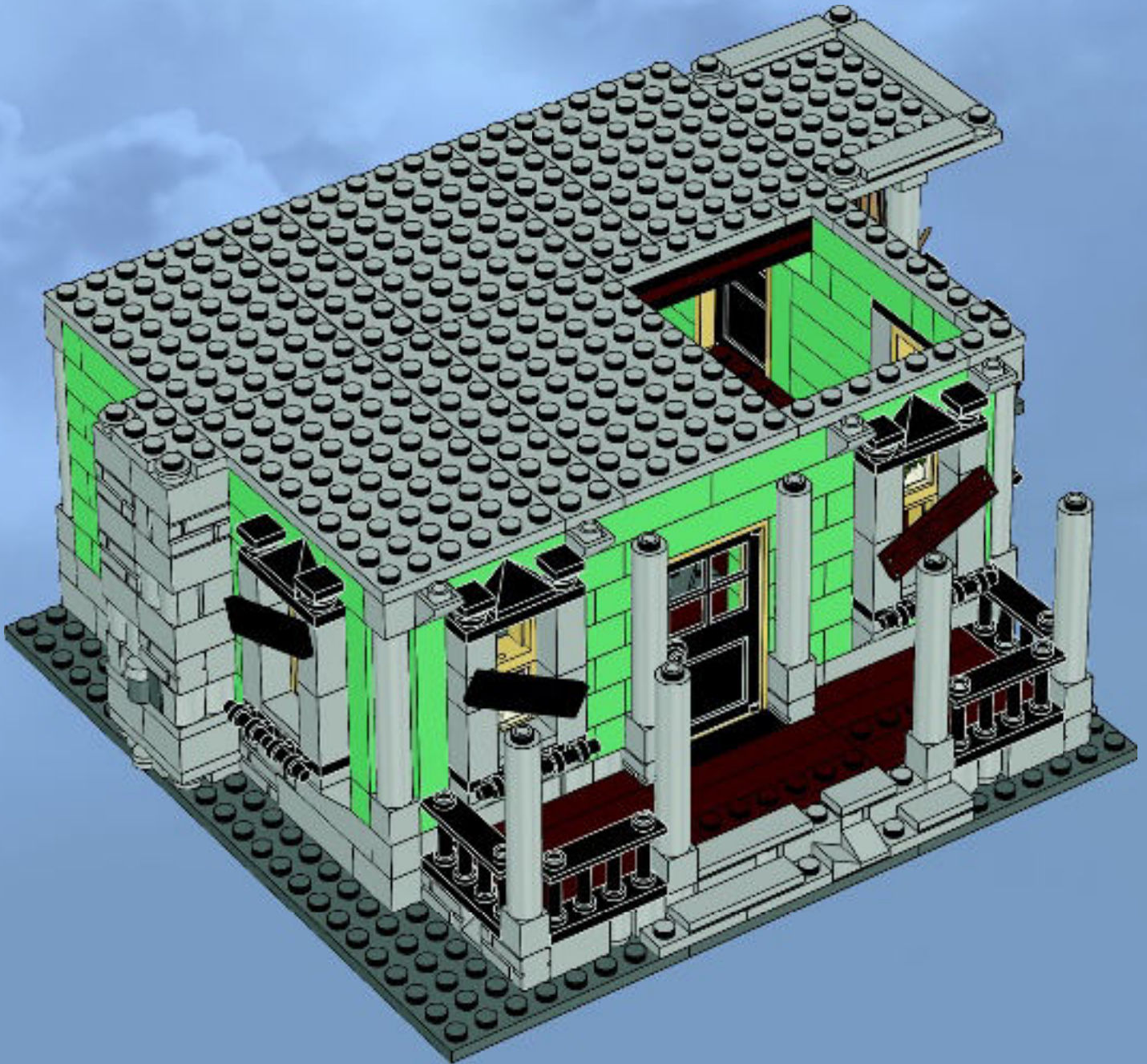



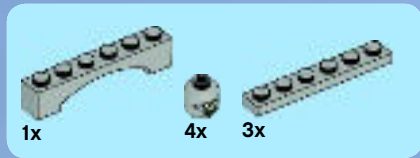

60

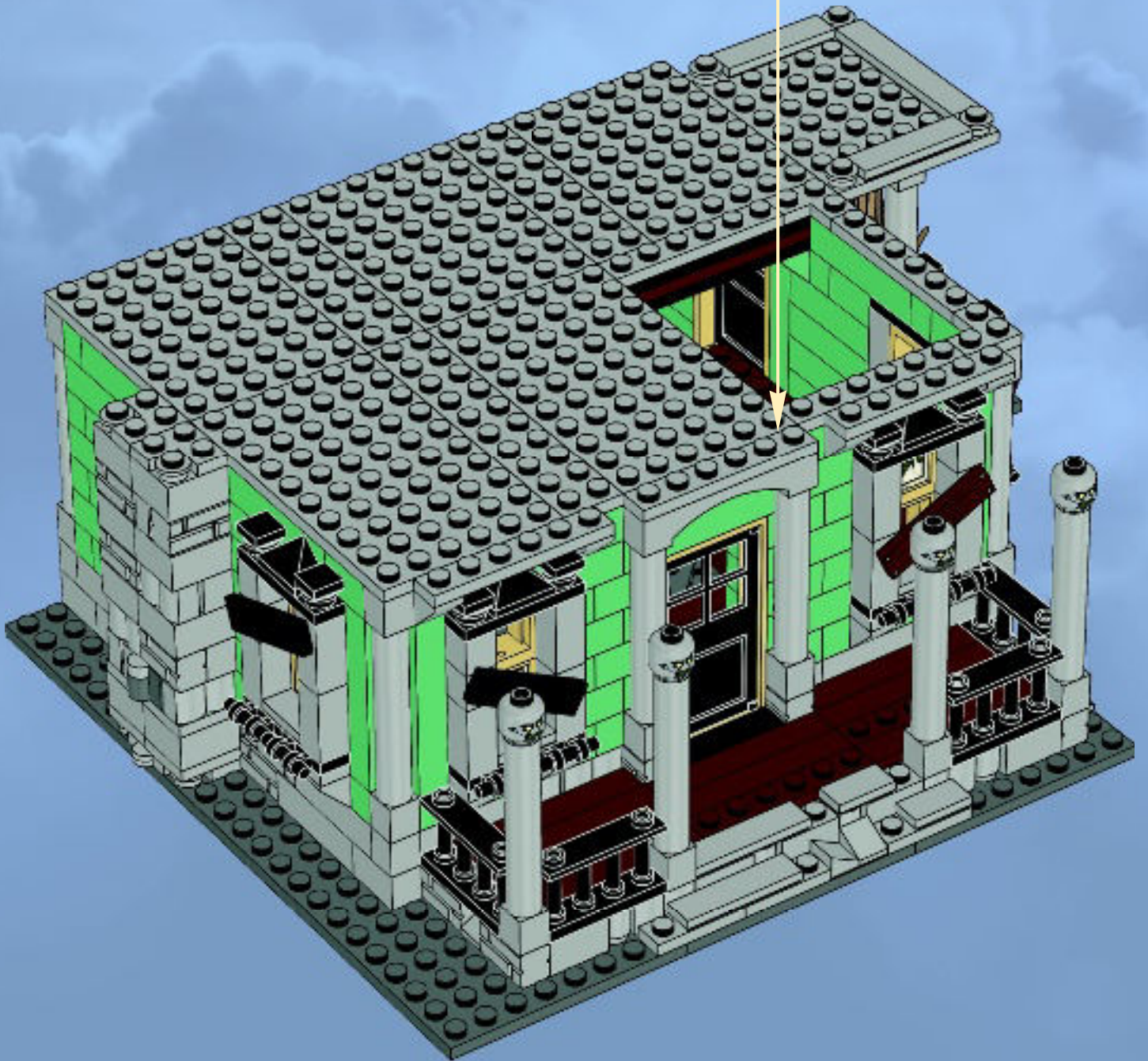
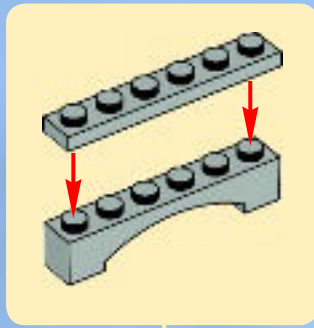





2x



4x



2x



2x

# 61

1

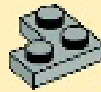

2

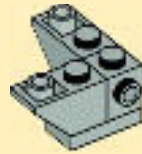

3

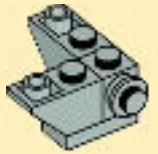

1

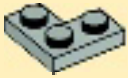

2

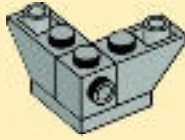

3

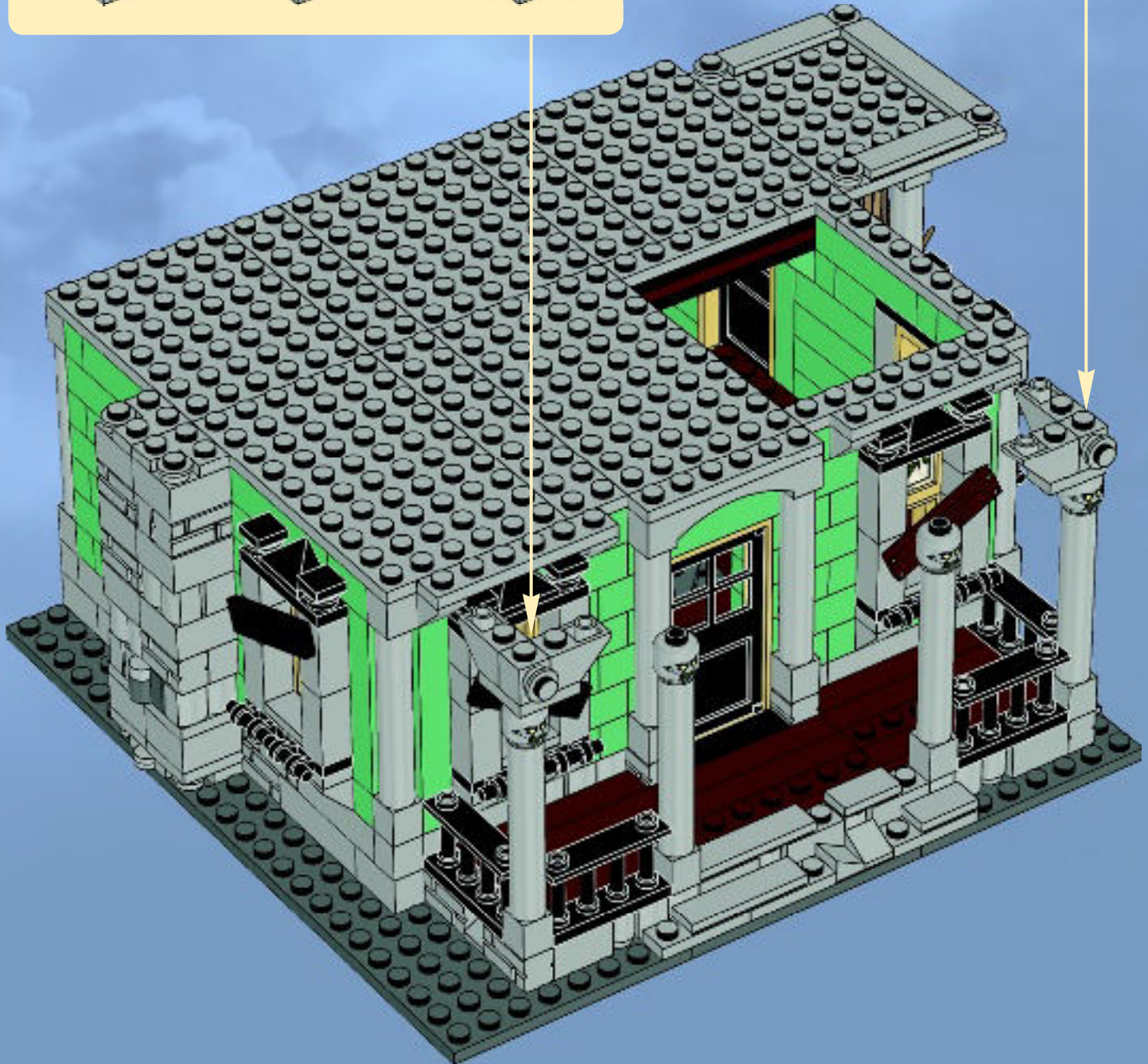
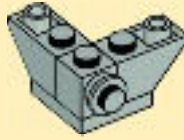



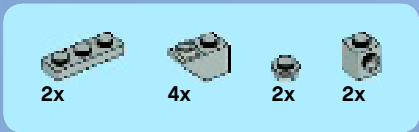

# 62

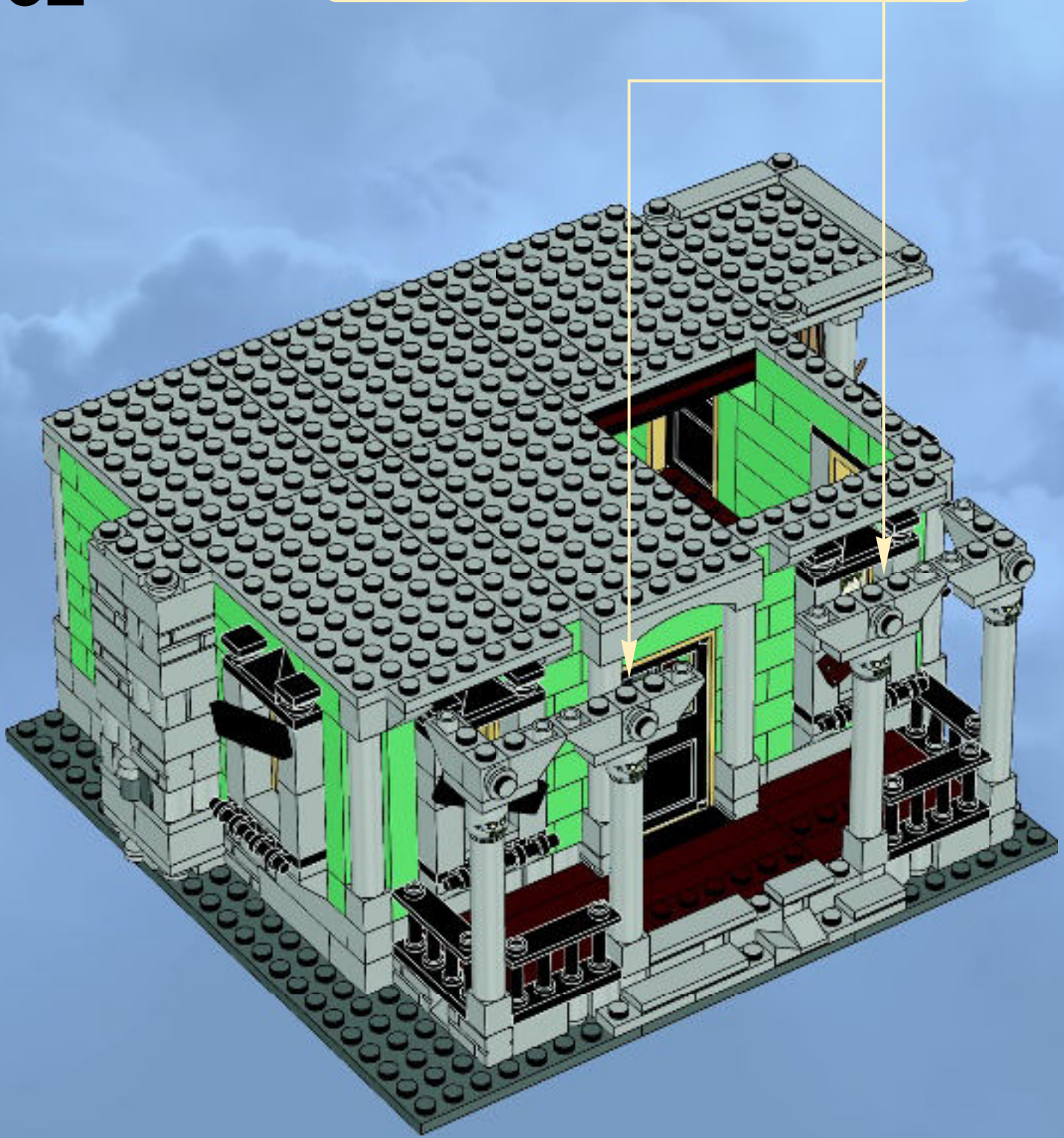
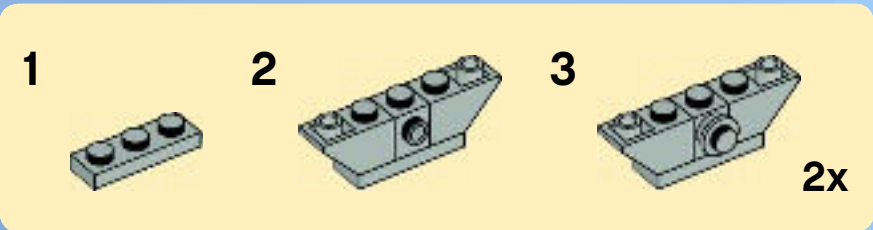



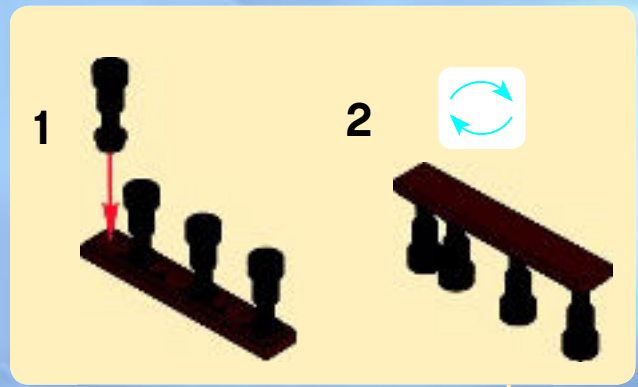
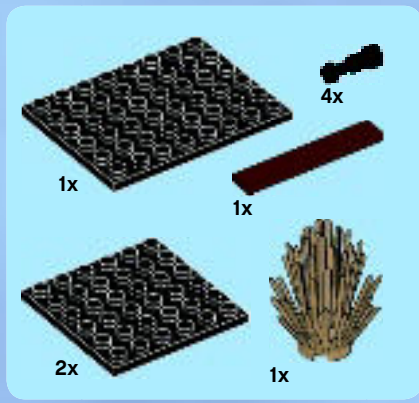

63

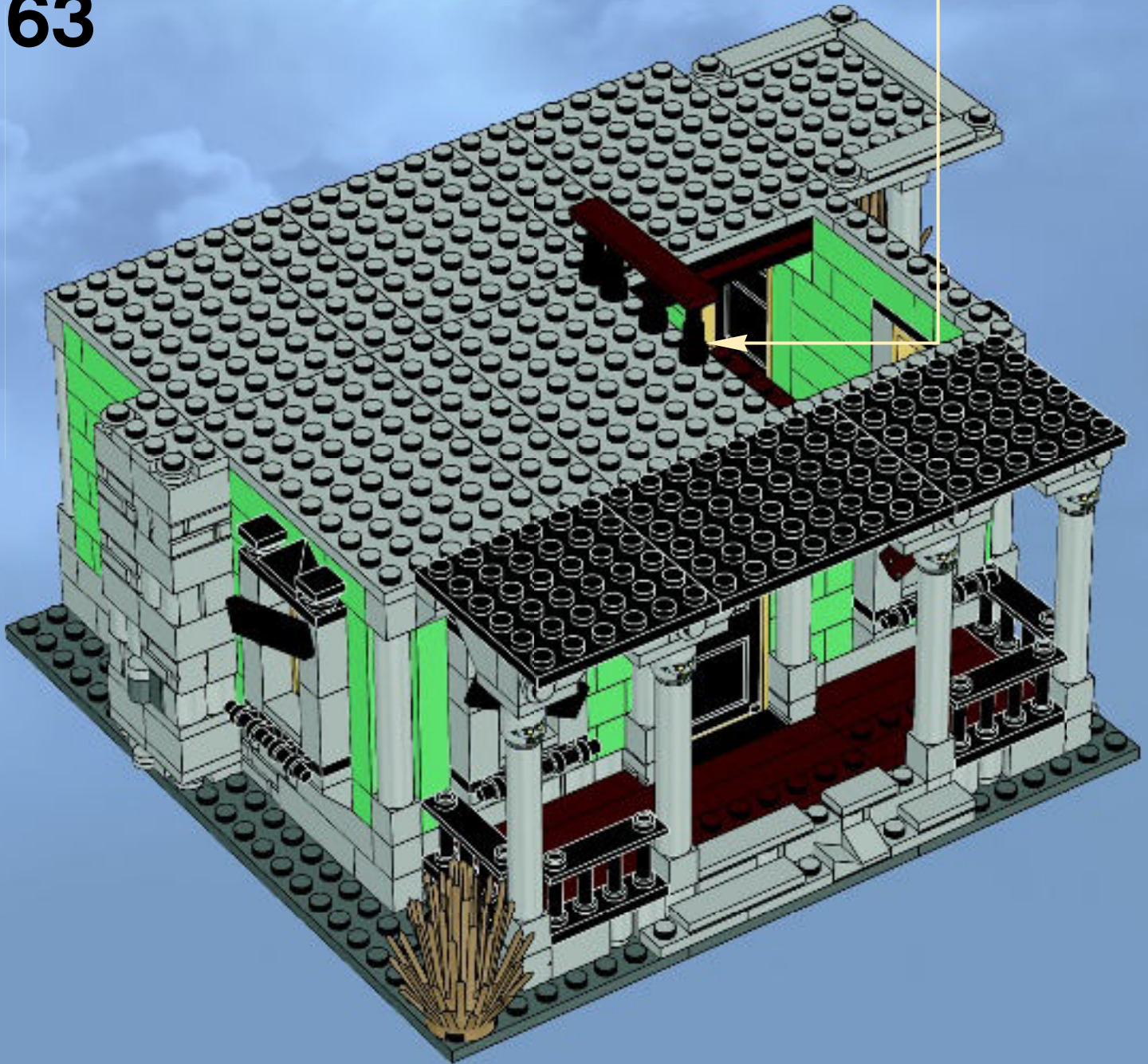





10x



6x

# 64

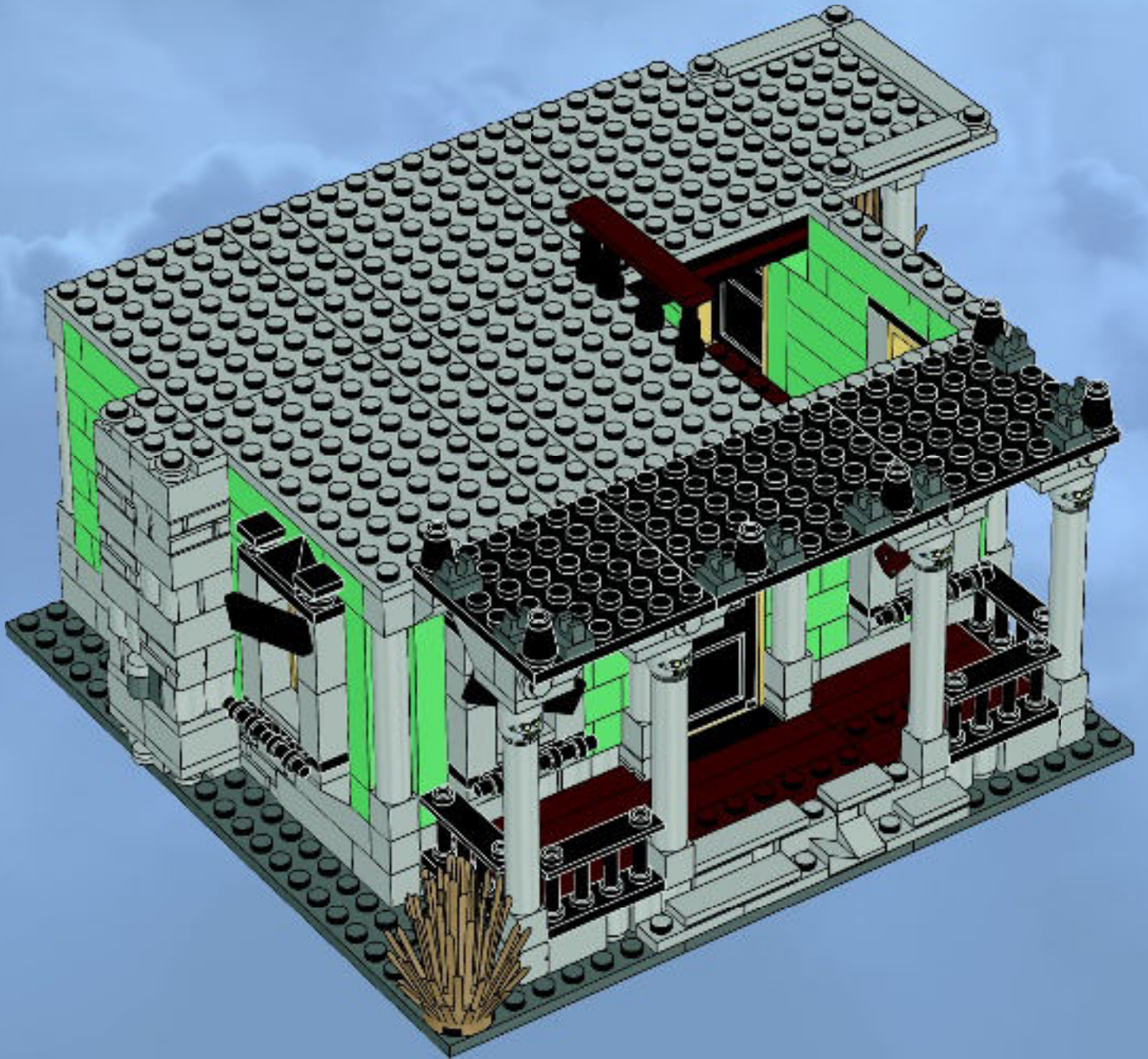





# 65

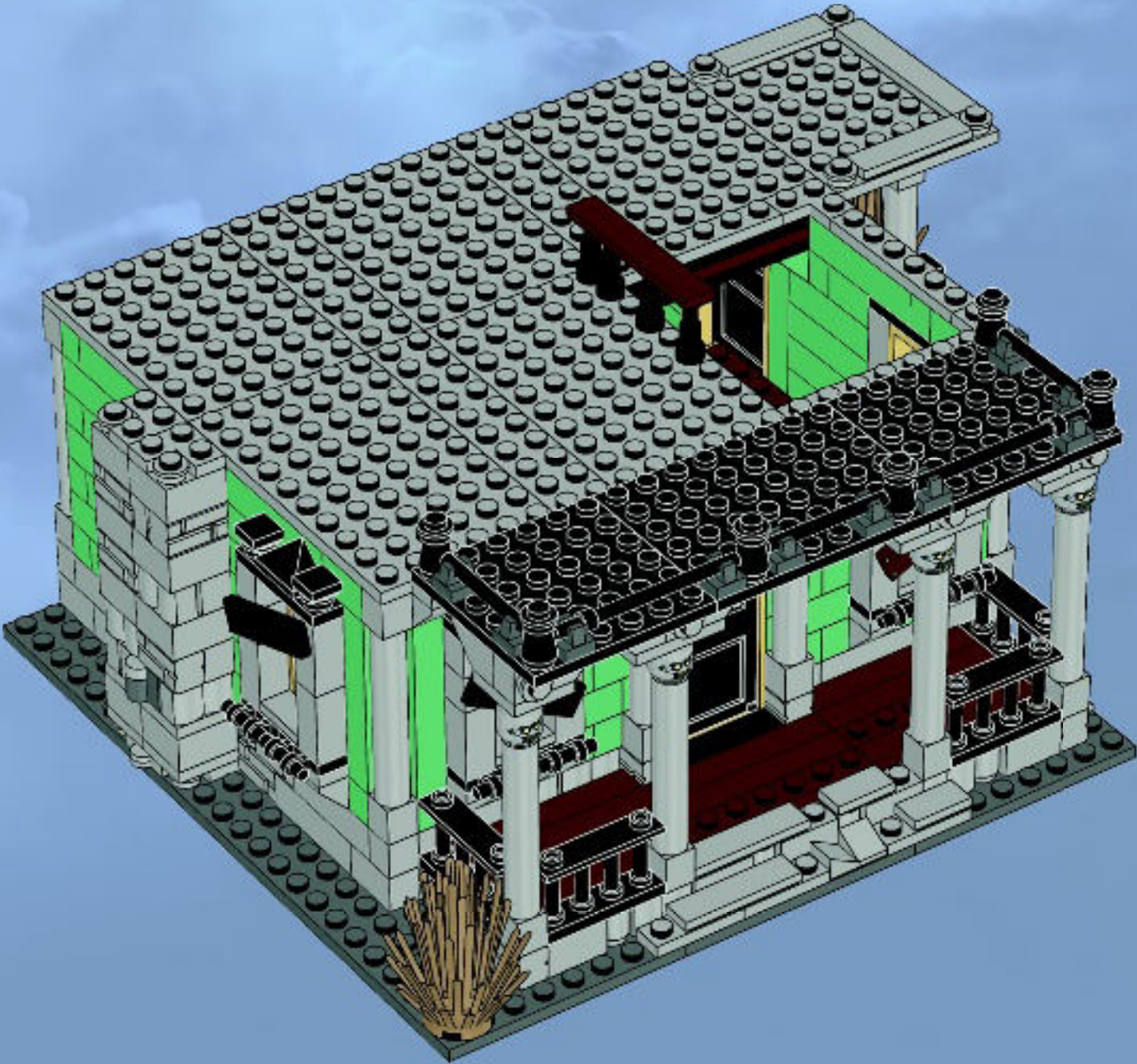





12x

# 66

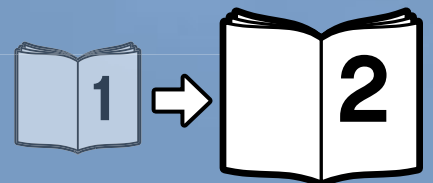

6015220 / 6015221



[www.LEGO.com](http://www.LEGO.com)





# MONSTER FIGHTERS

10228





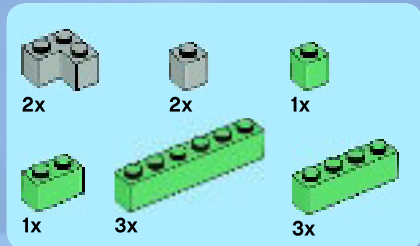
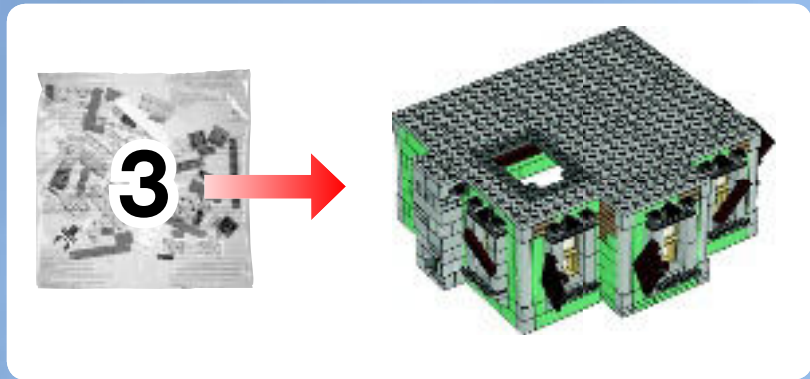

67

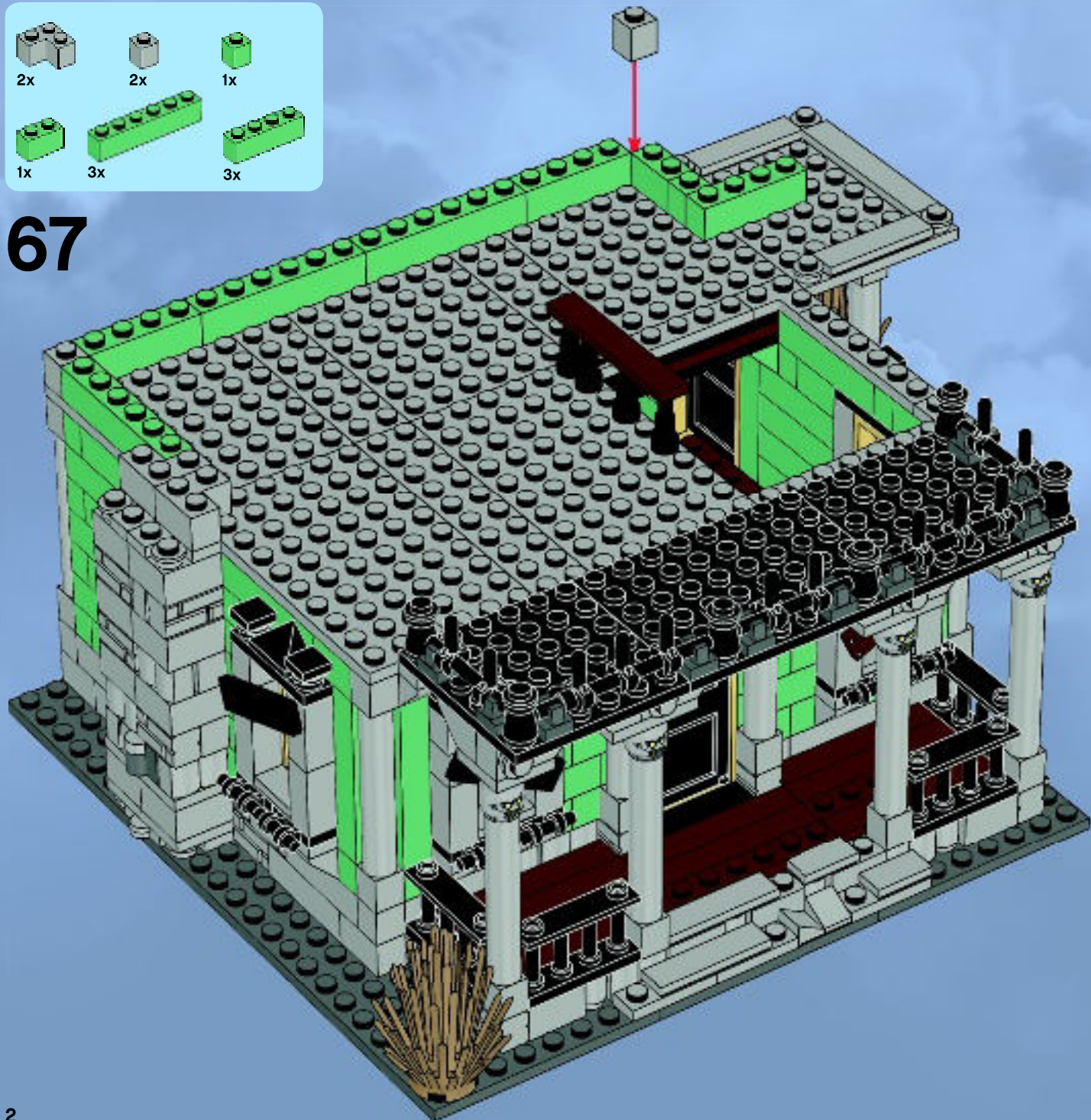



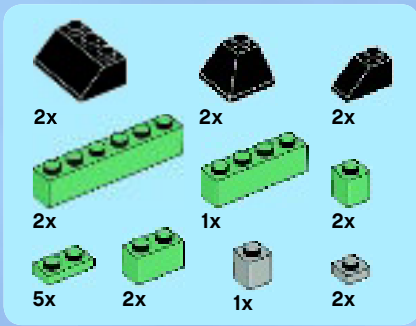

# 68

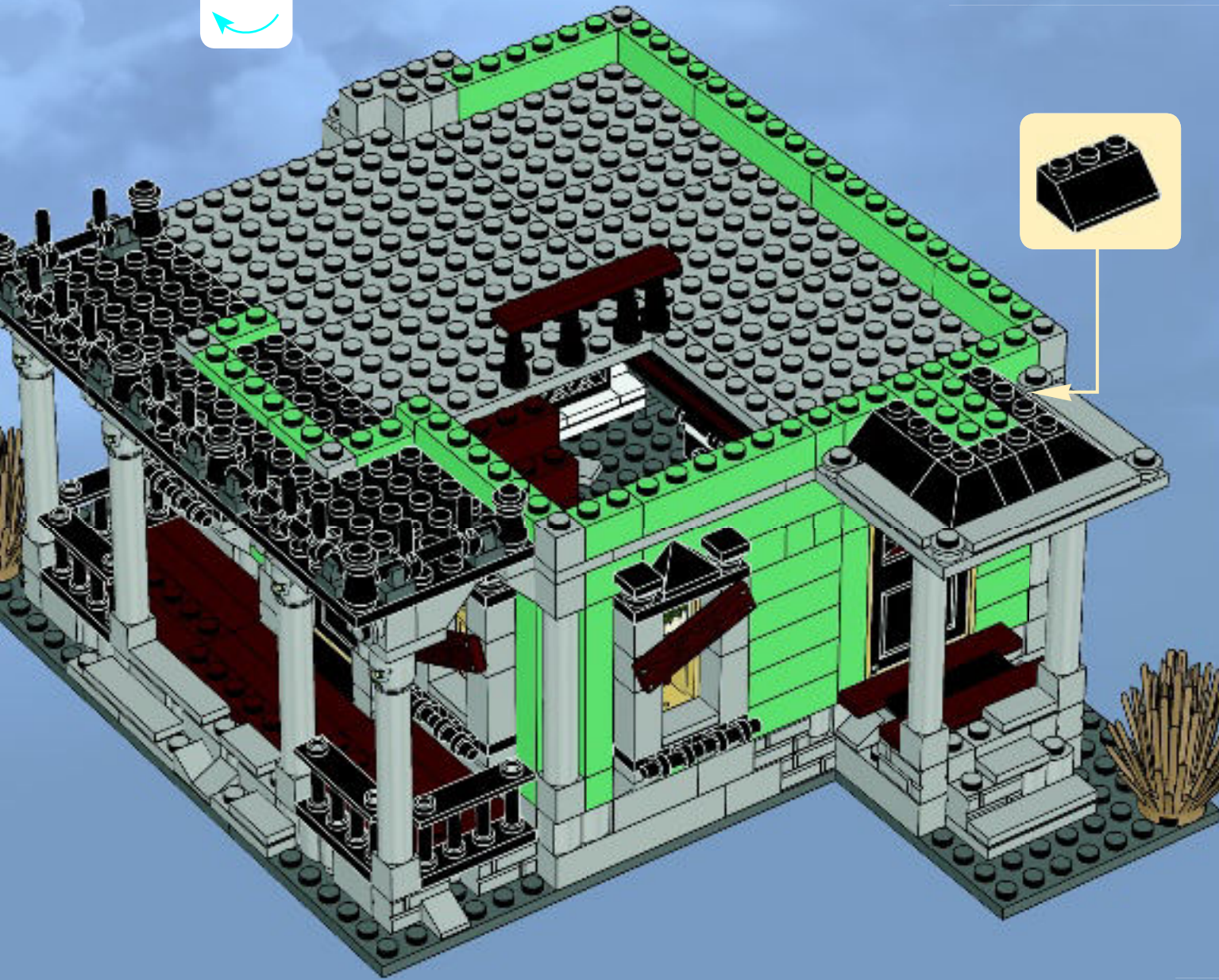



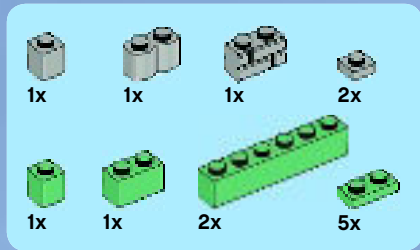

# 69





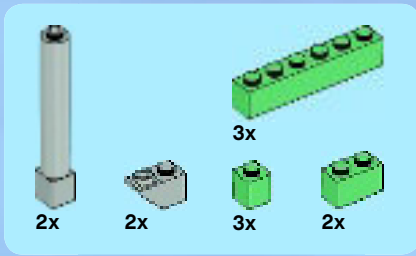

70

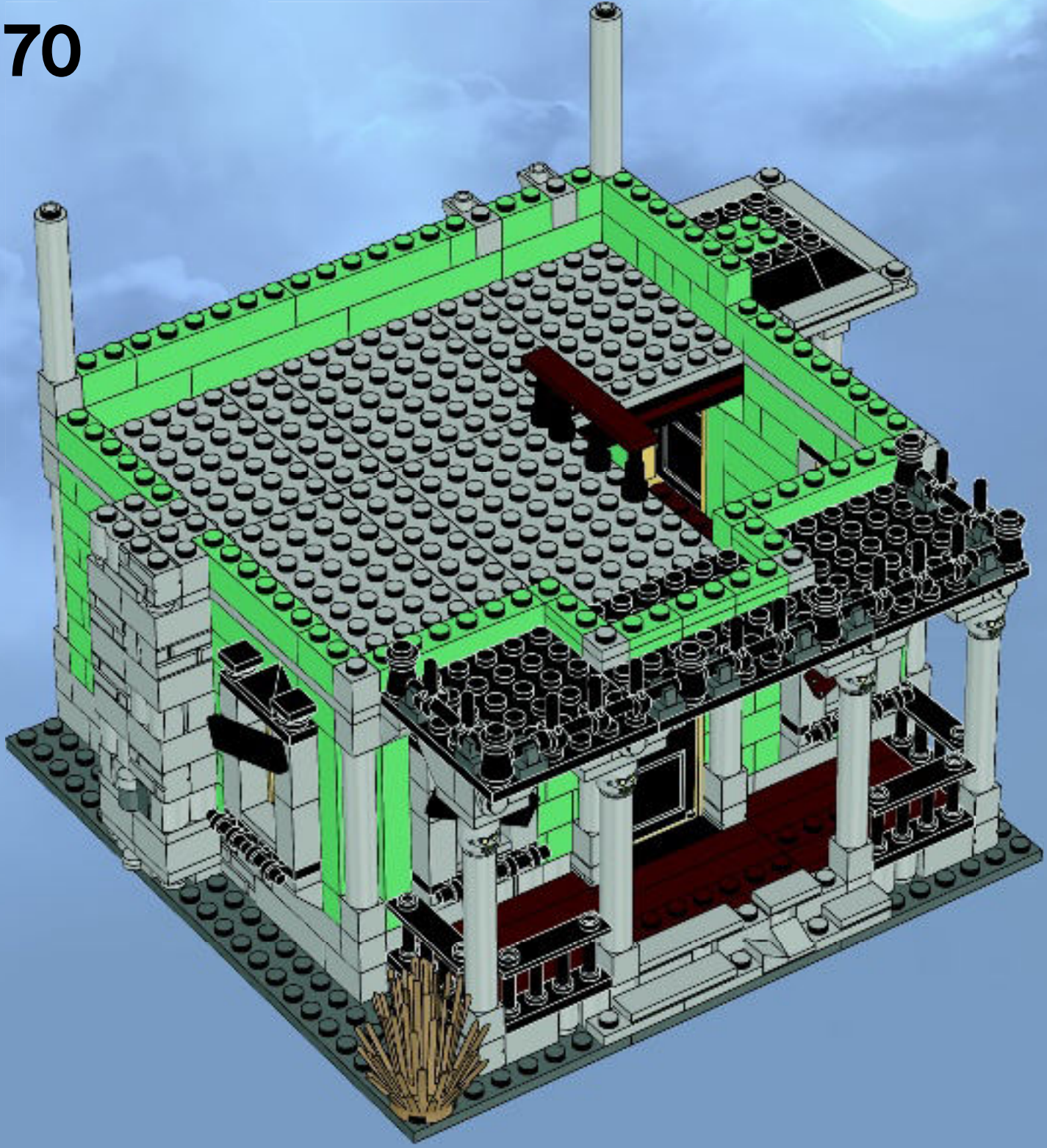



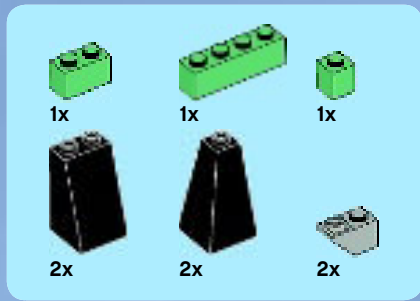

71

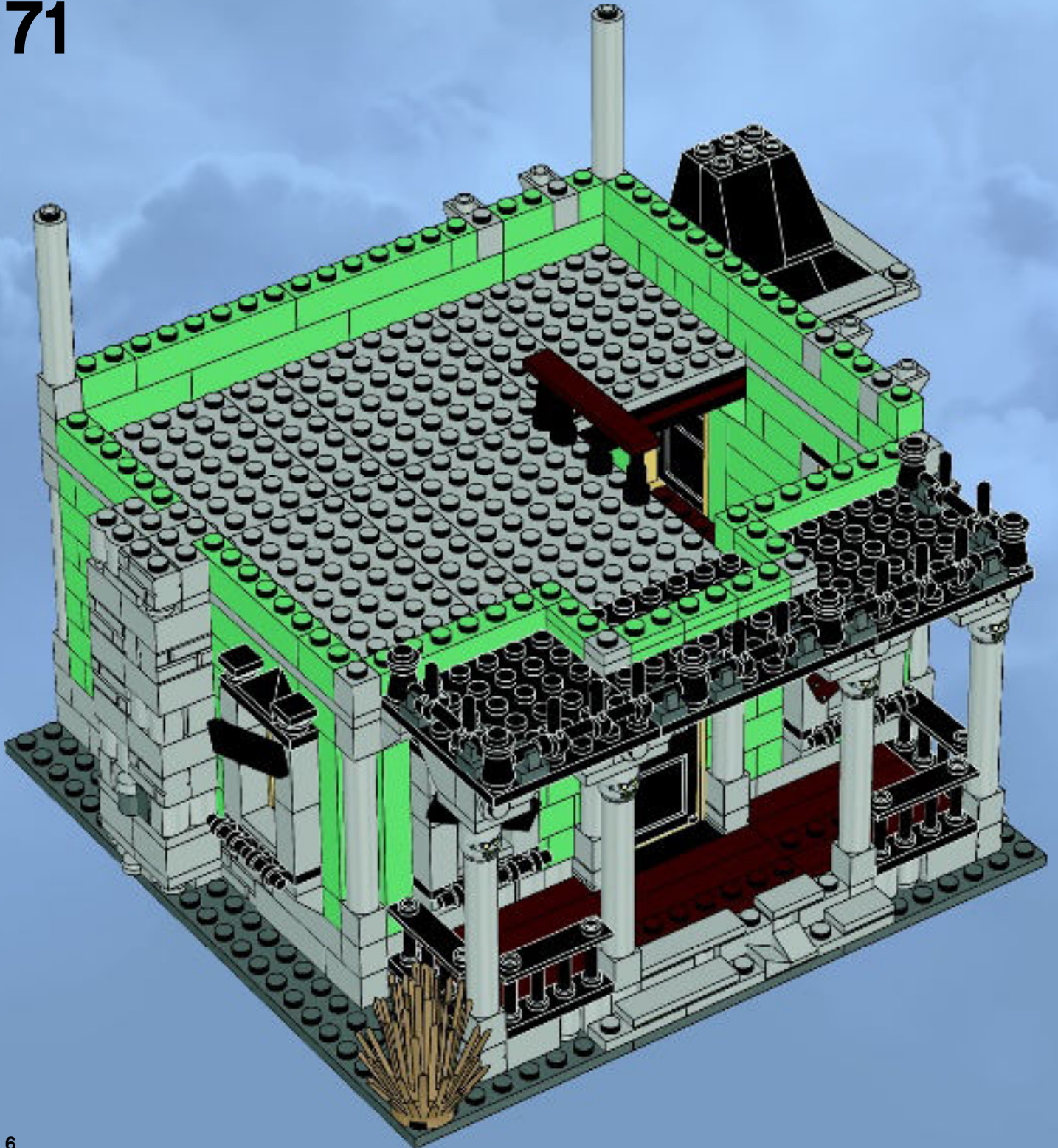





6x



8x



5x

# 72

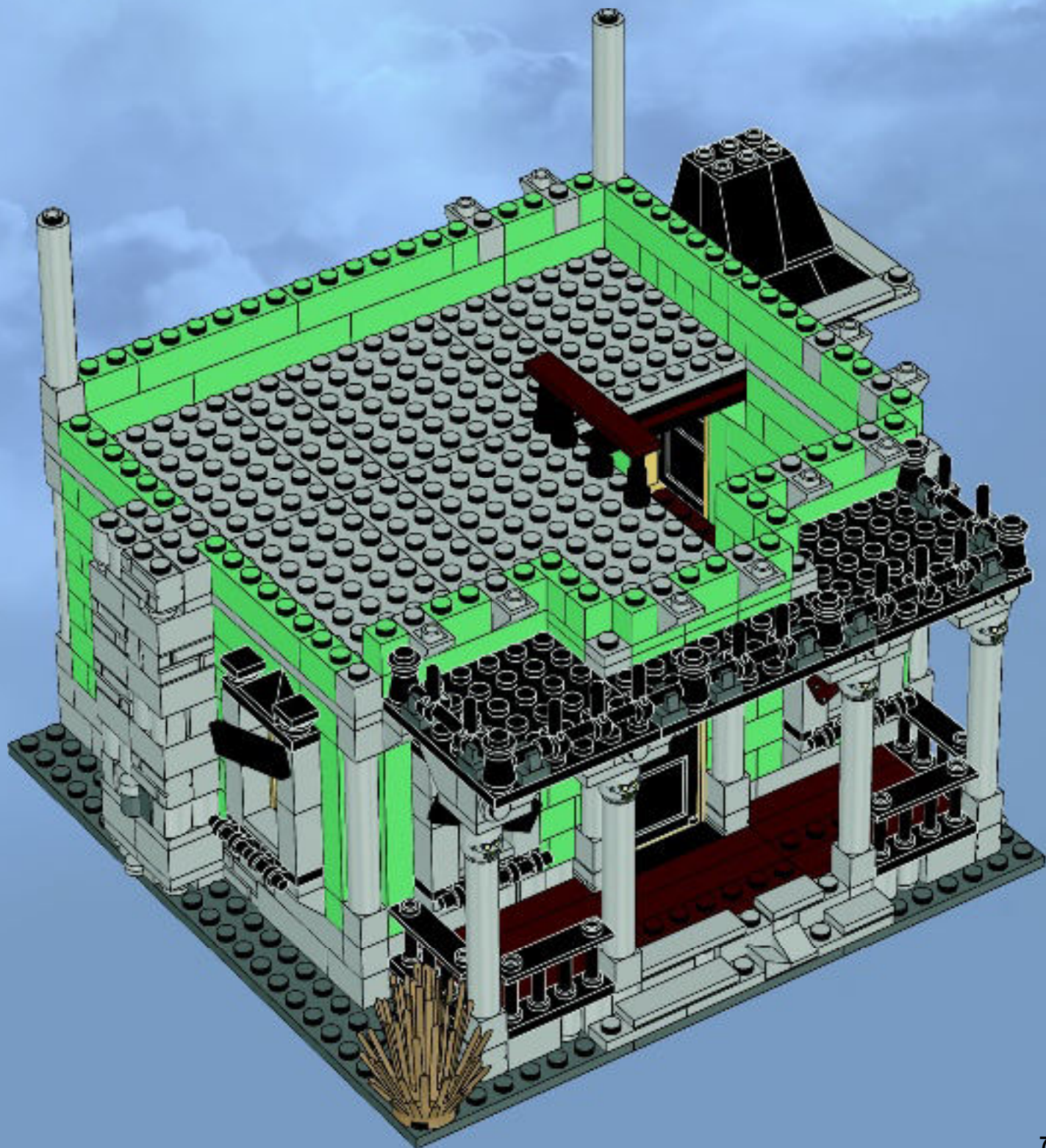



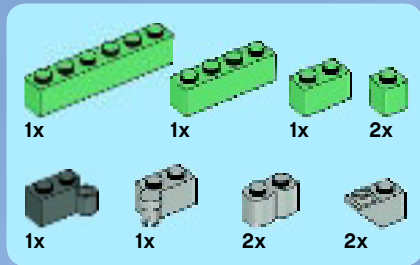

73

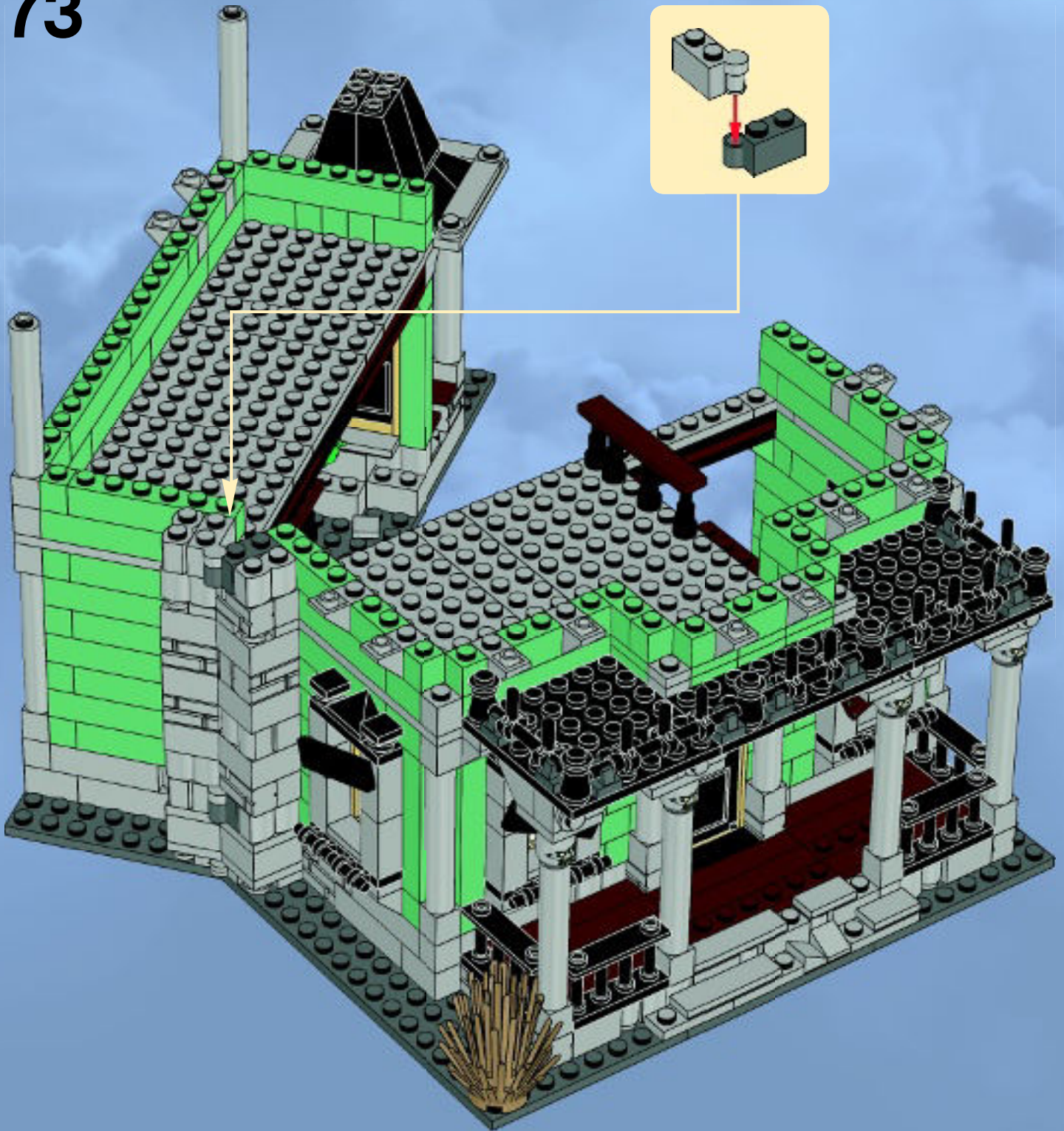



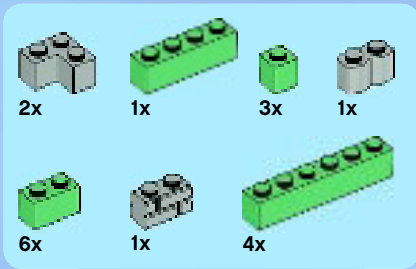

74

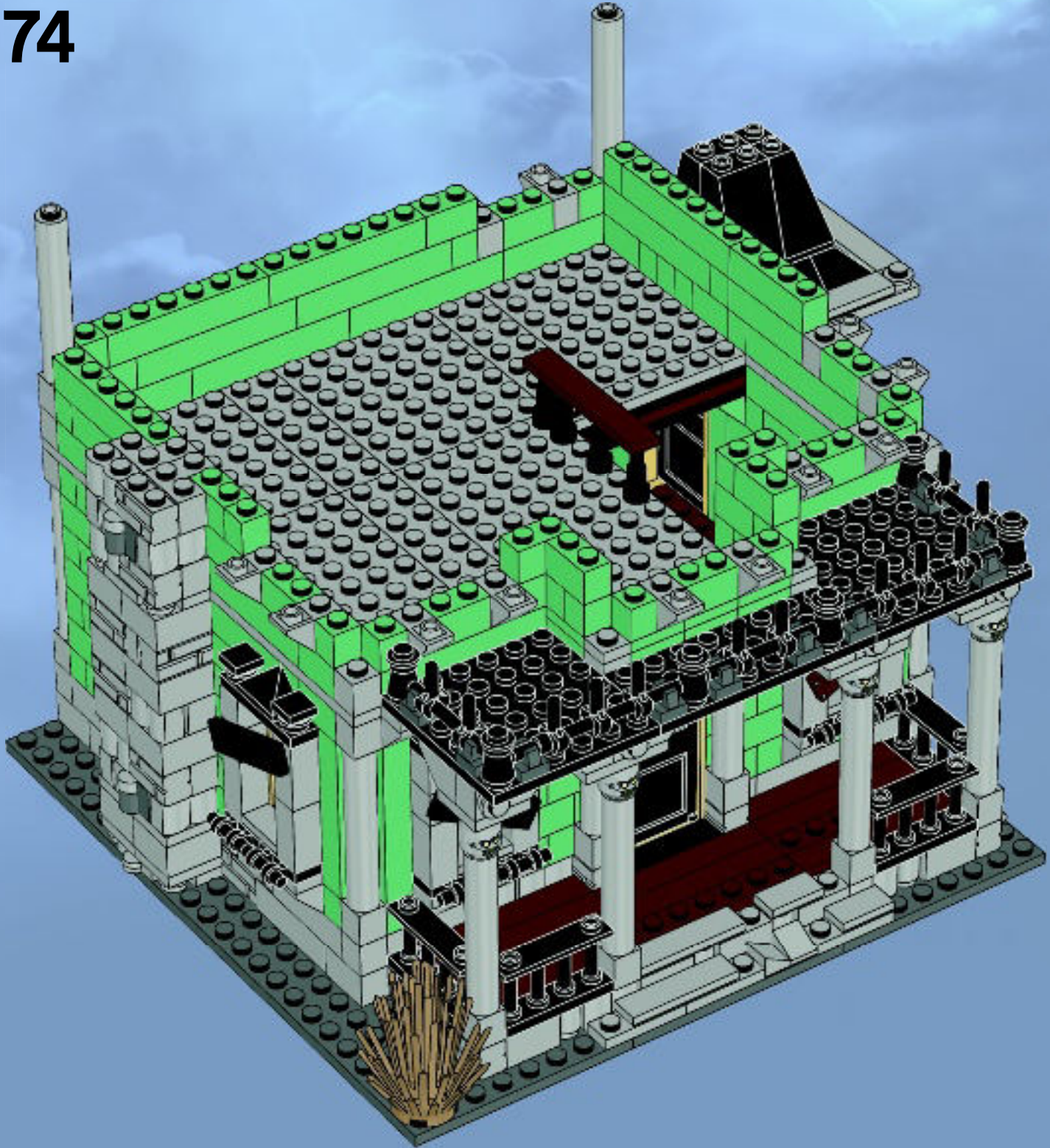



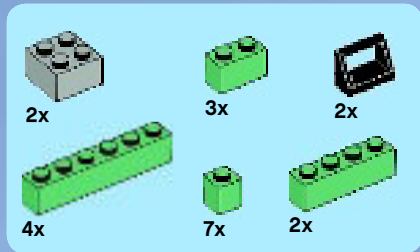

75

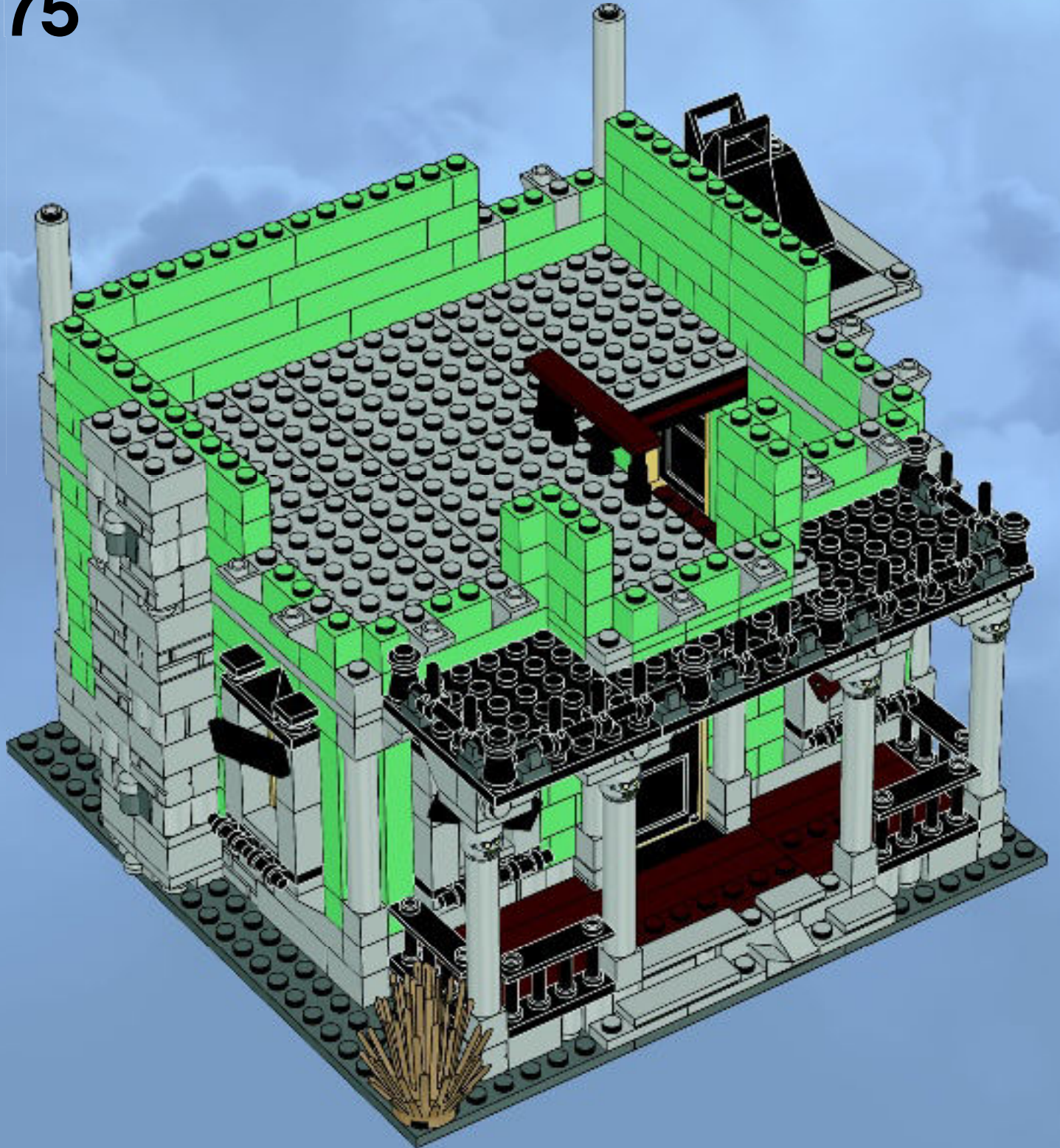



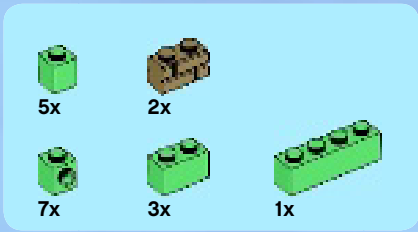

# 76

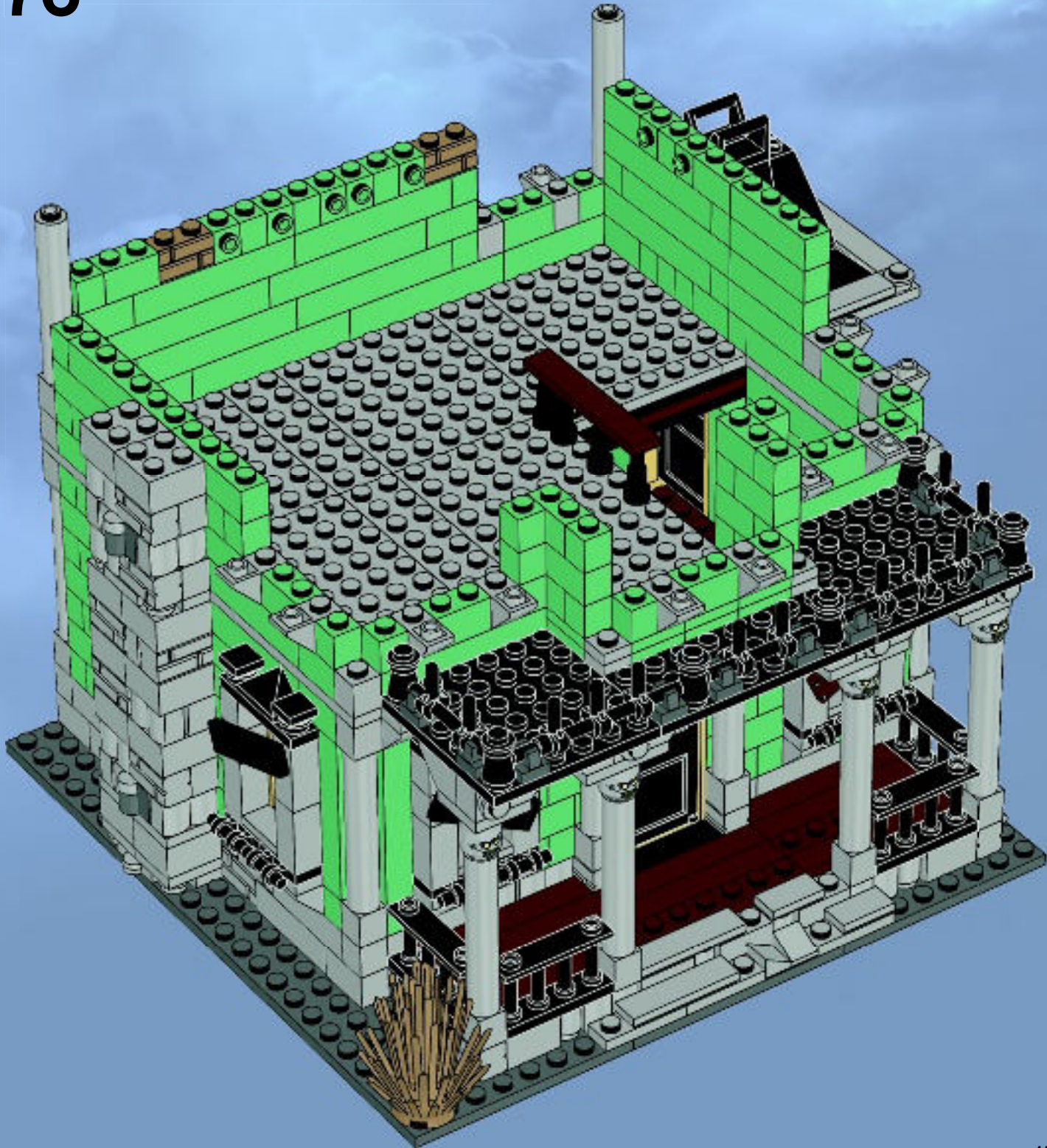



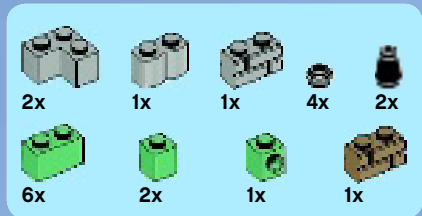

77





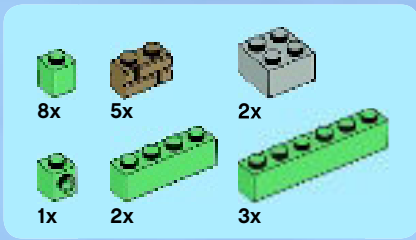

# 78

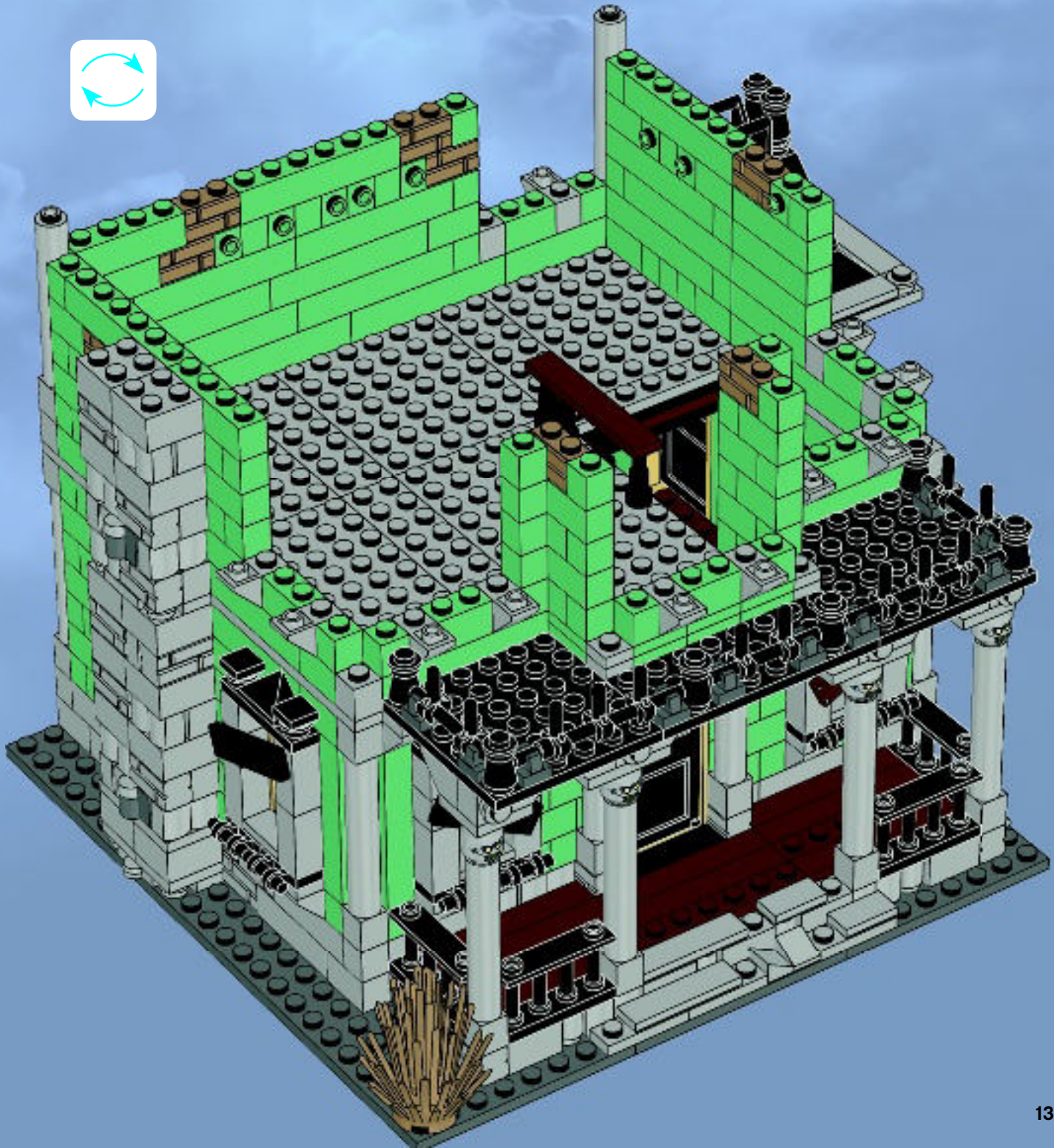



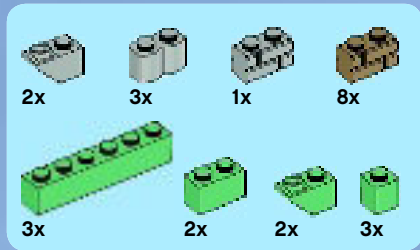

# 79

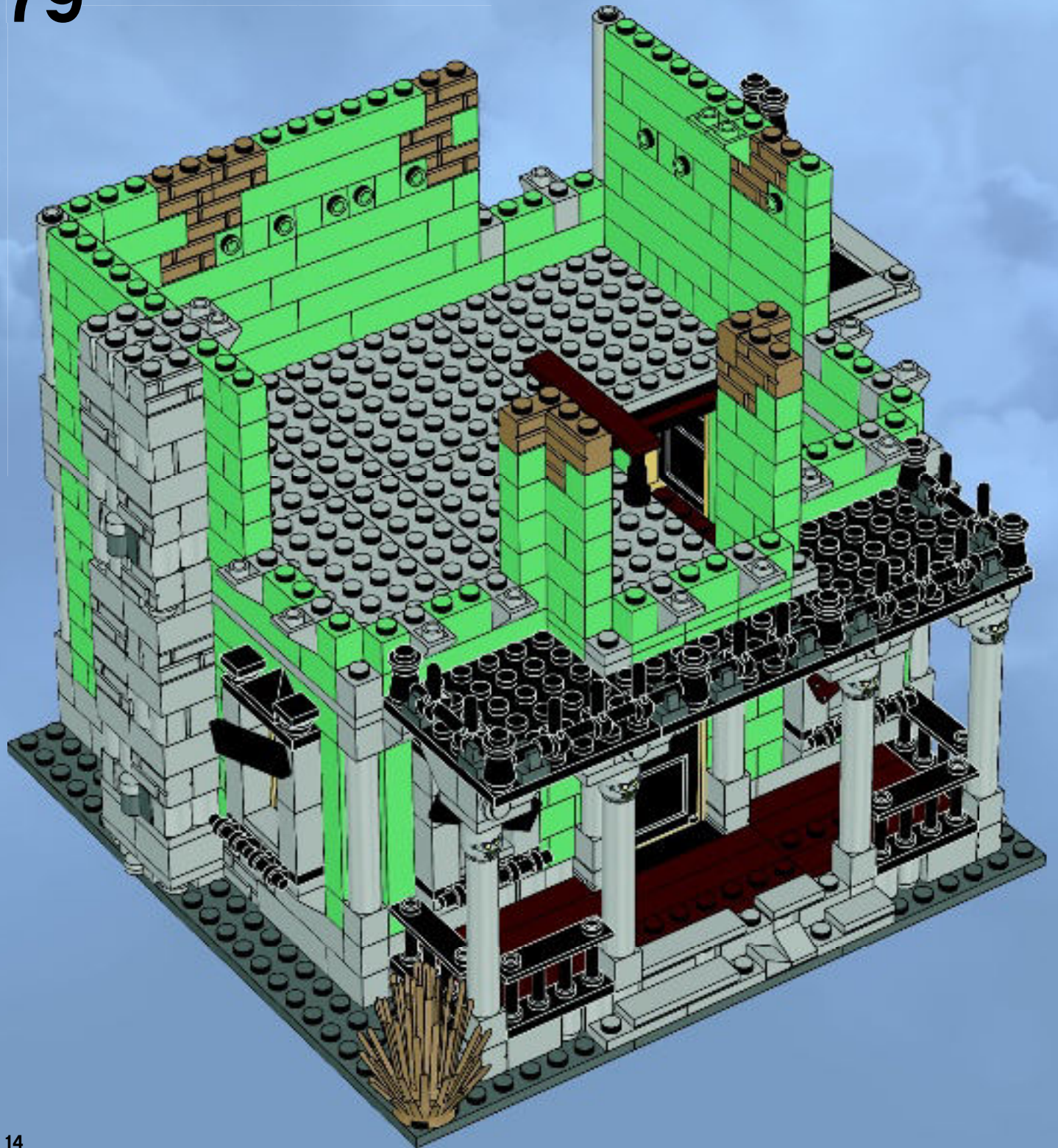



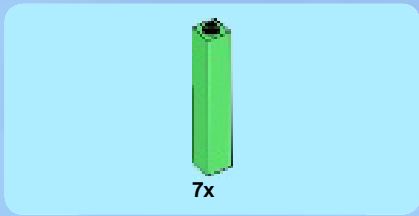

80

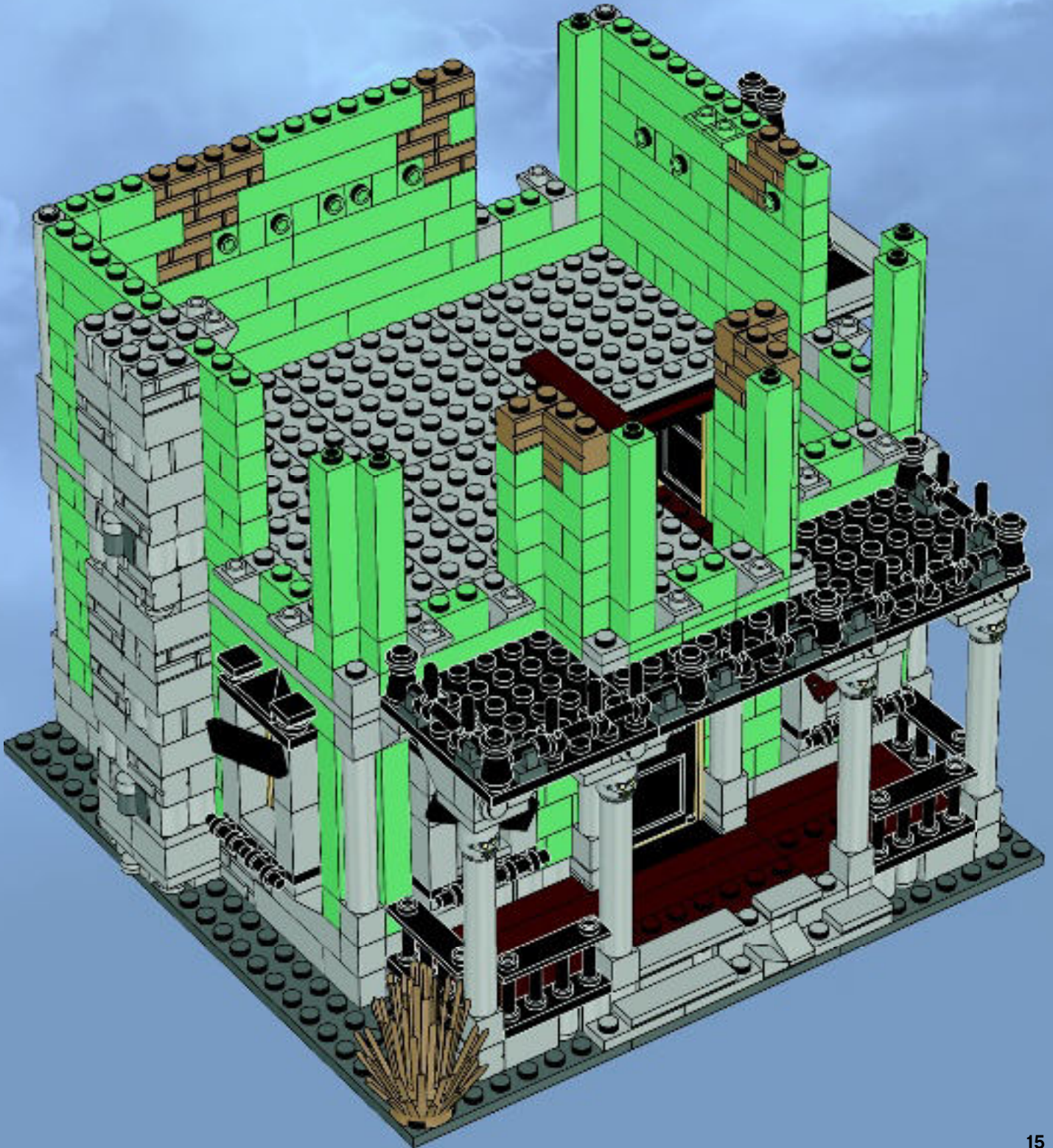





4x

# 81

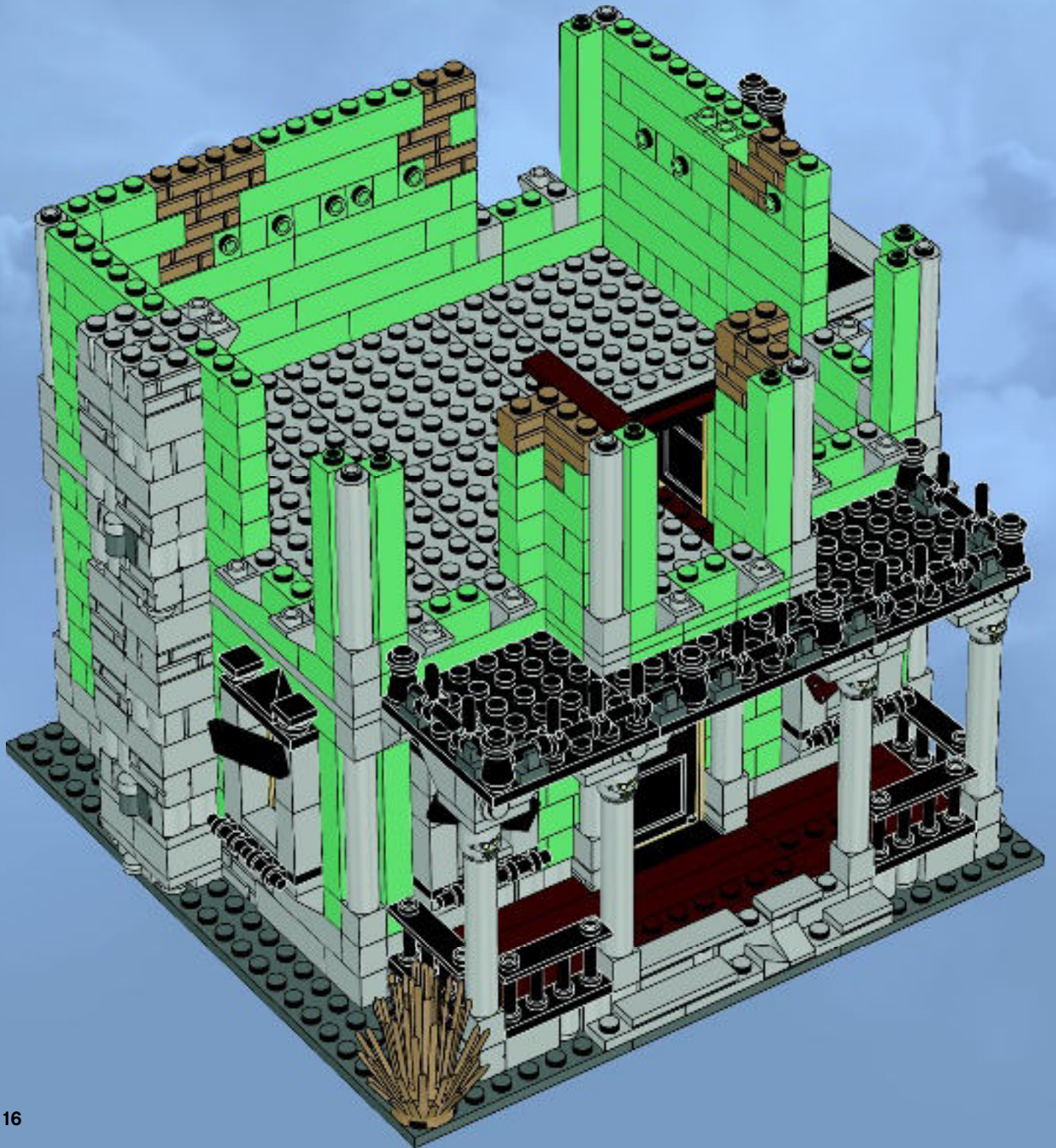



1x

1

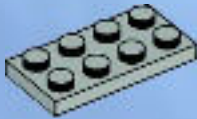

1x



2x

2



1x



2x



1x

3

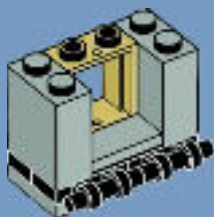

2x



1x

4

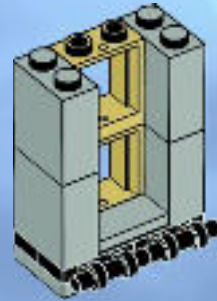

1x

5



1x



2x

6

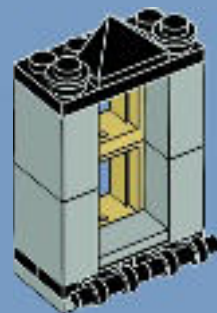



2x

7

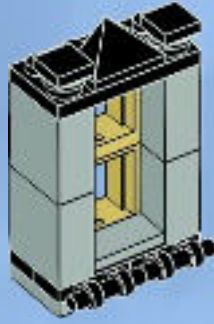

82

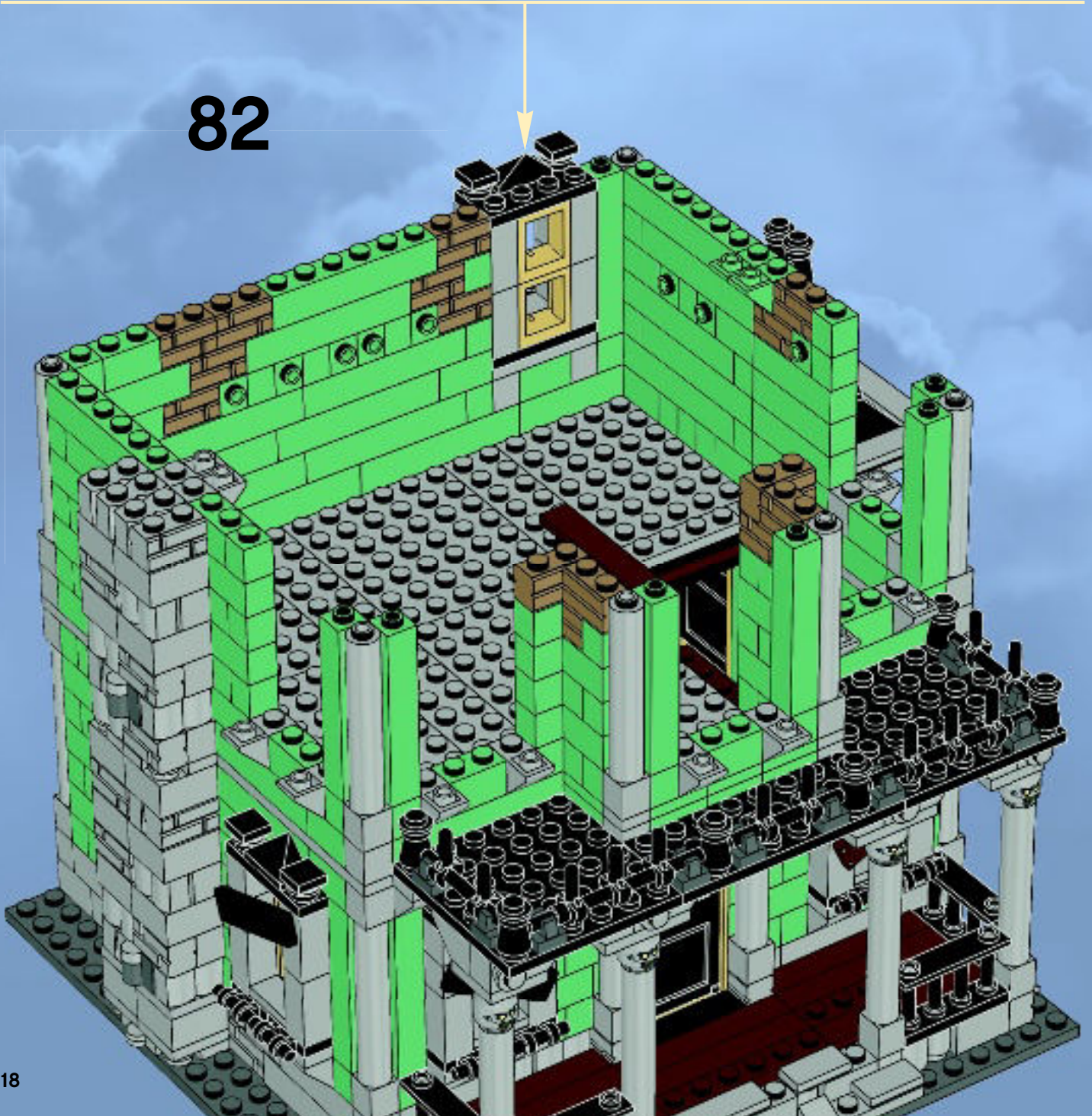



1x

1

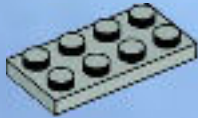

1x



2x

2



1x



1x



1x



1x

3

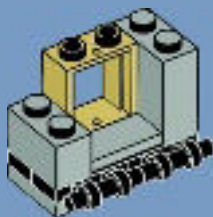

1x



1x

4

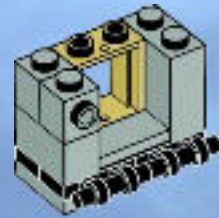

1x



1x



1x



1x

5

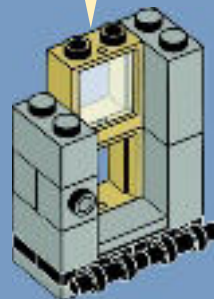
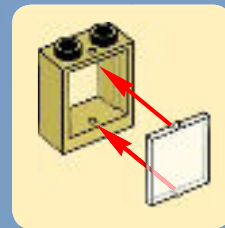





1x



1x

6

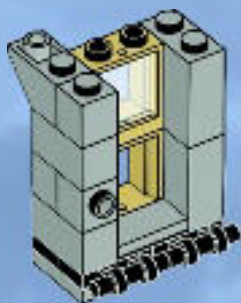

1x



2x

8

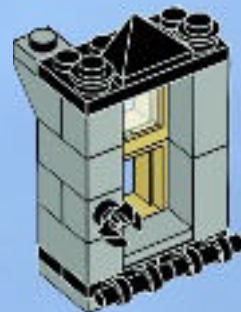

1x



1x



1x

7

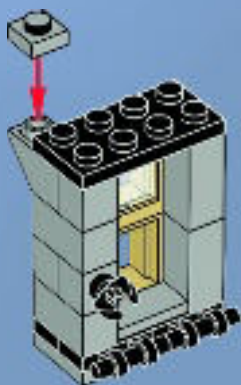

2x



1x

9



83

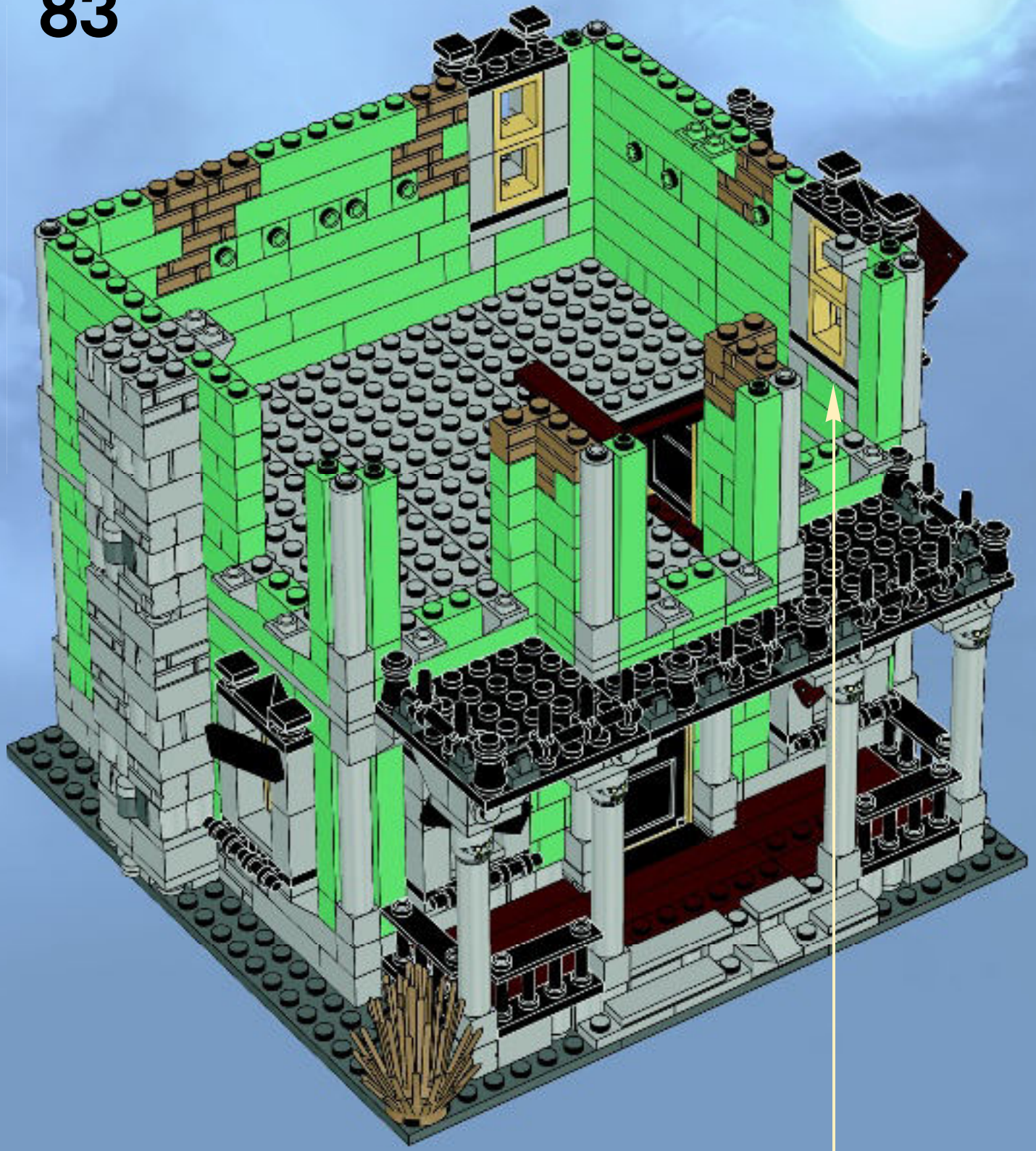





1x

1

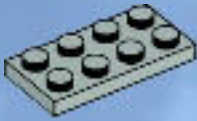

1x



2x

2



1x



2x



1x



1x

3

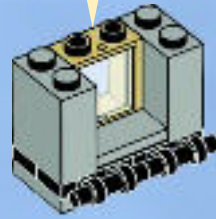
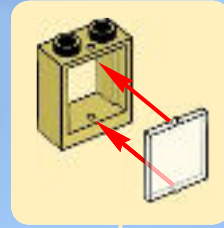

1x



1x

4

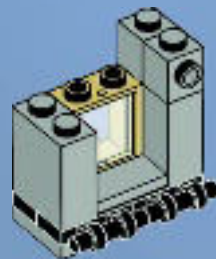

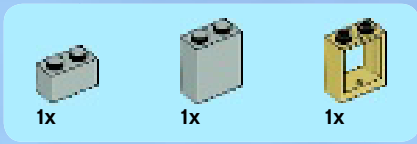

5

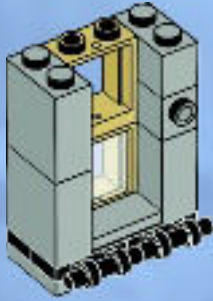

6



7



8





84

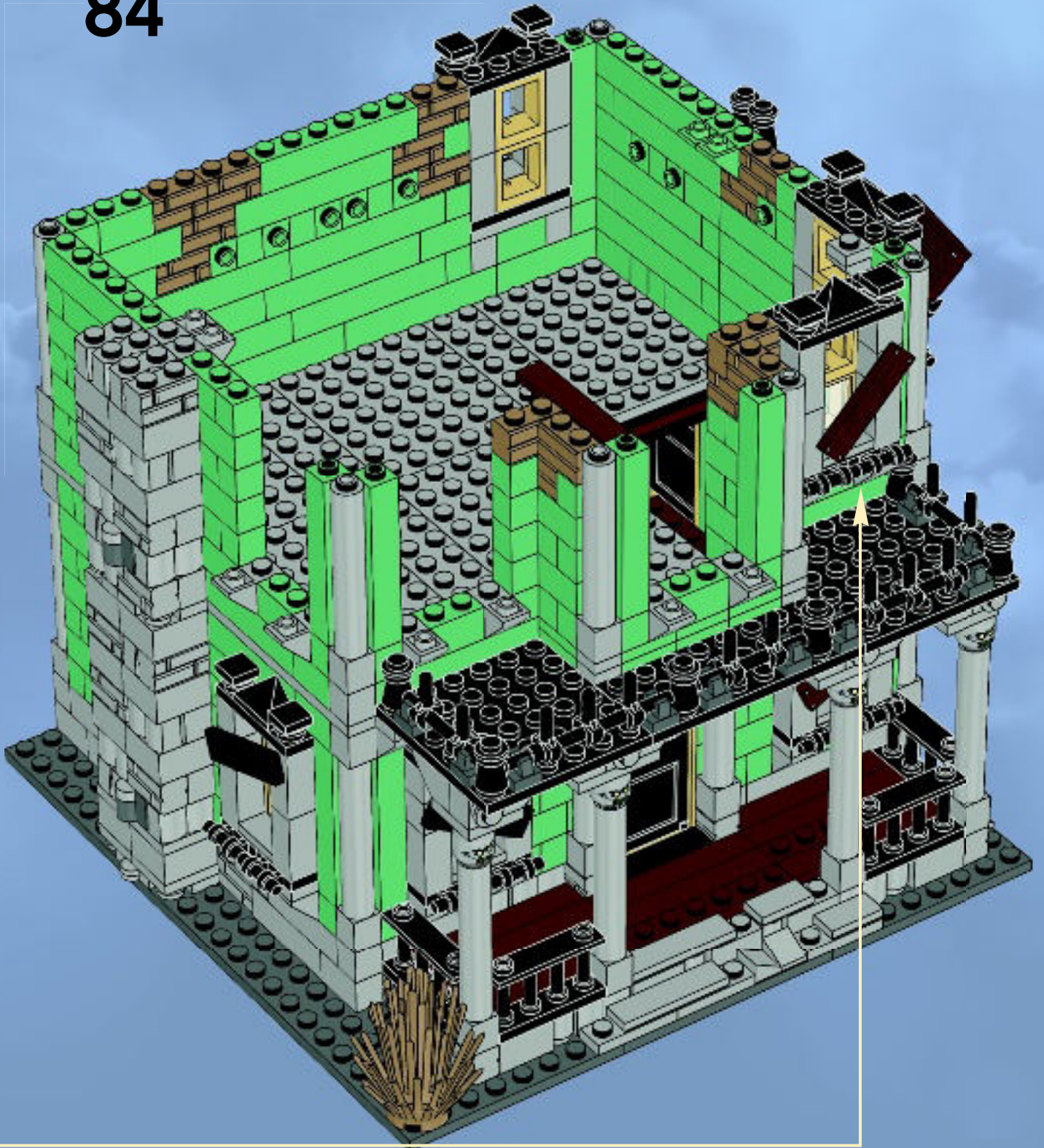



1x

1



1x



2x

2



1x



1x



1x



1x

3

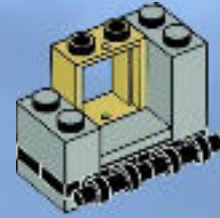

1x



1x

4

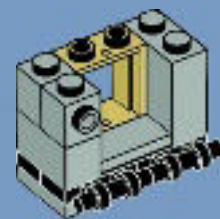



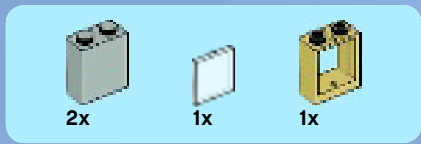

5

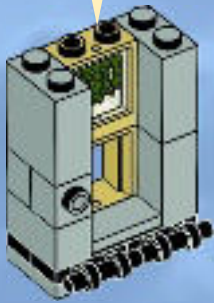
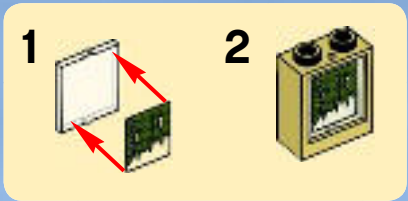

6



7

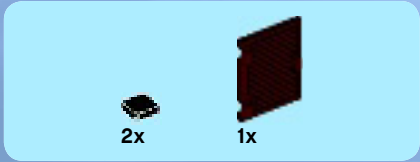

8



85

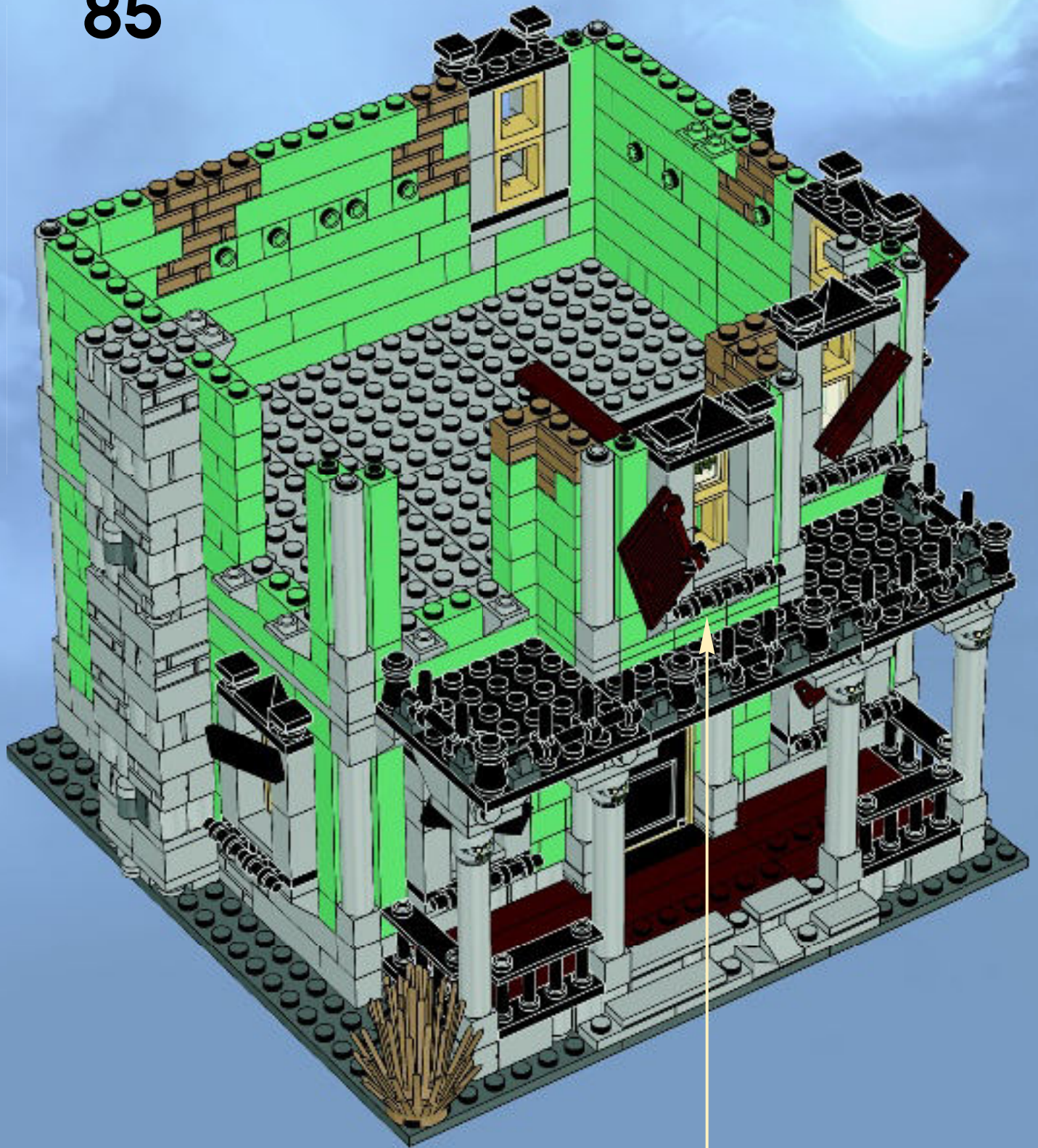





1x

1

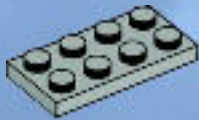

1x



2x

2



1x



1x



1x



1x

3

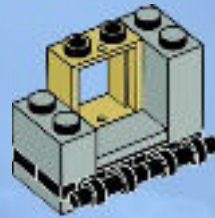

1x



1x

4

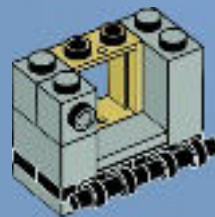



2x



1x



1x

# 5

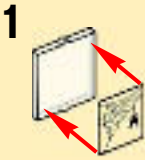

1



2

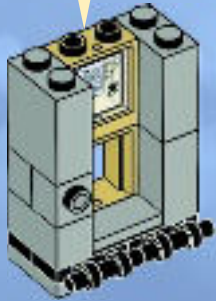

1x



1x

# 6



1x



2x

# 7

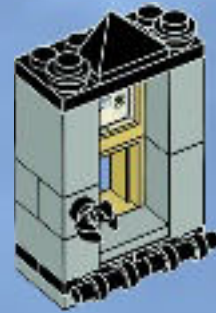

2x



1x

# 8





86

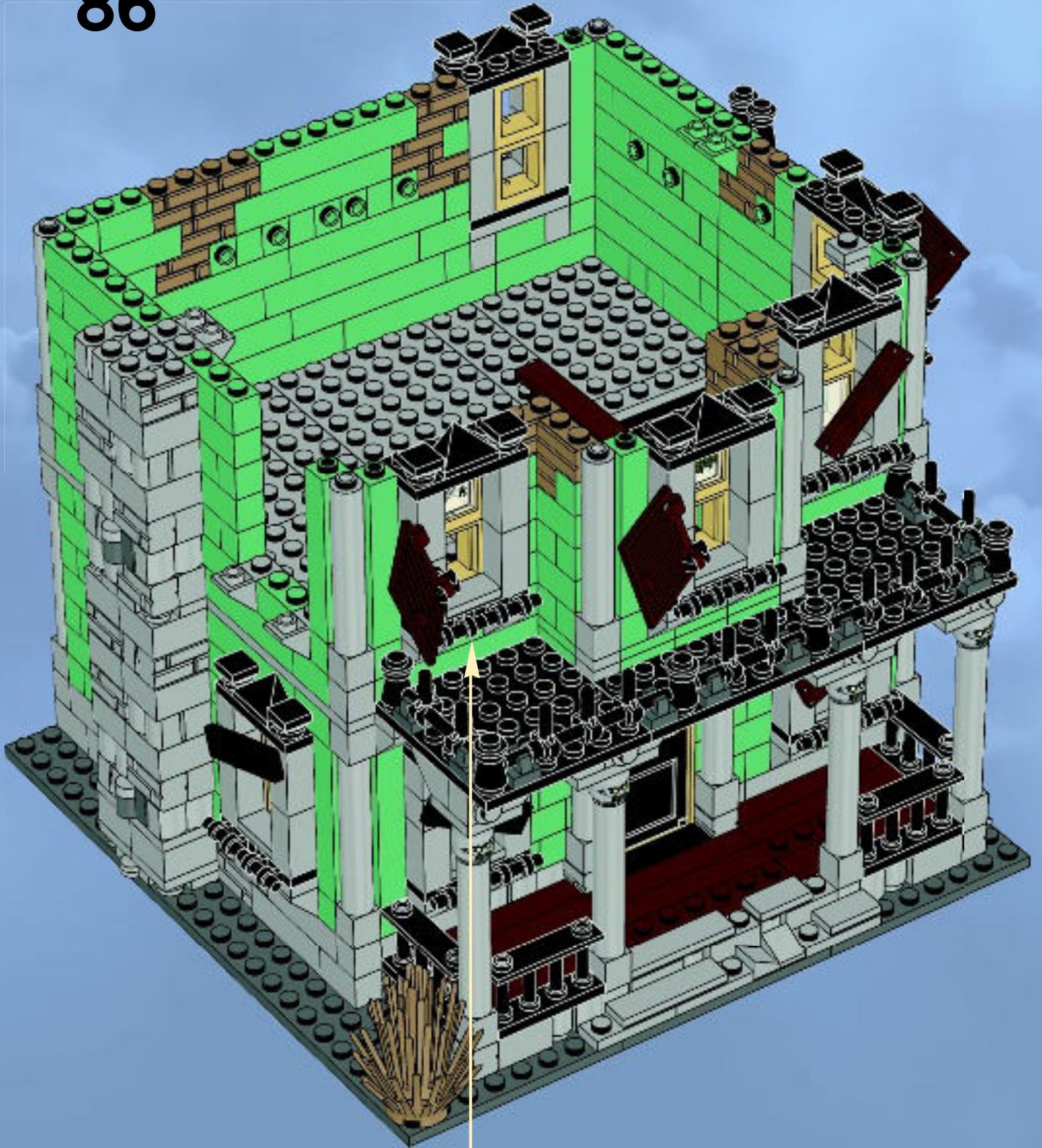



1x

1

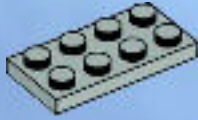

1x



2x

2



1x



1x



1x



1x

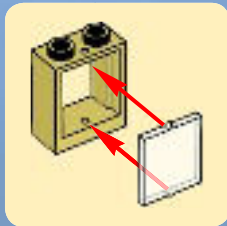

3

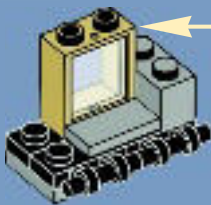

1x



1x



1x

4

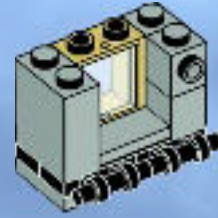

1x



1x

5

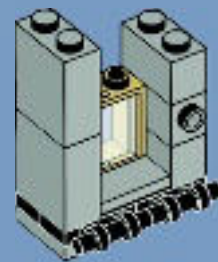





6

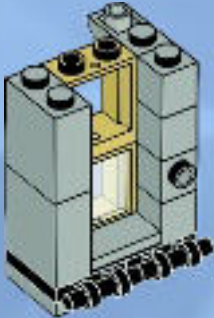

7

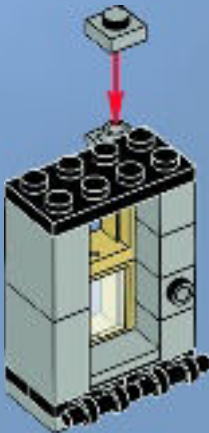

8

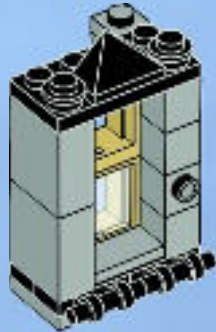

9



87

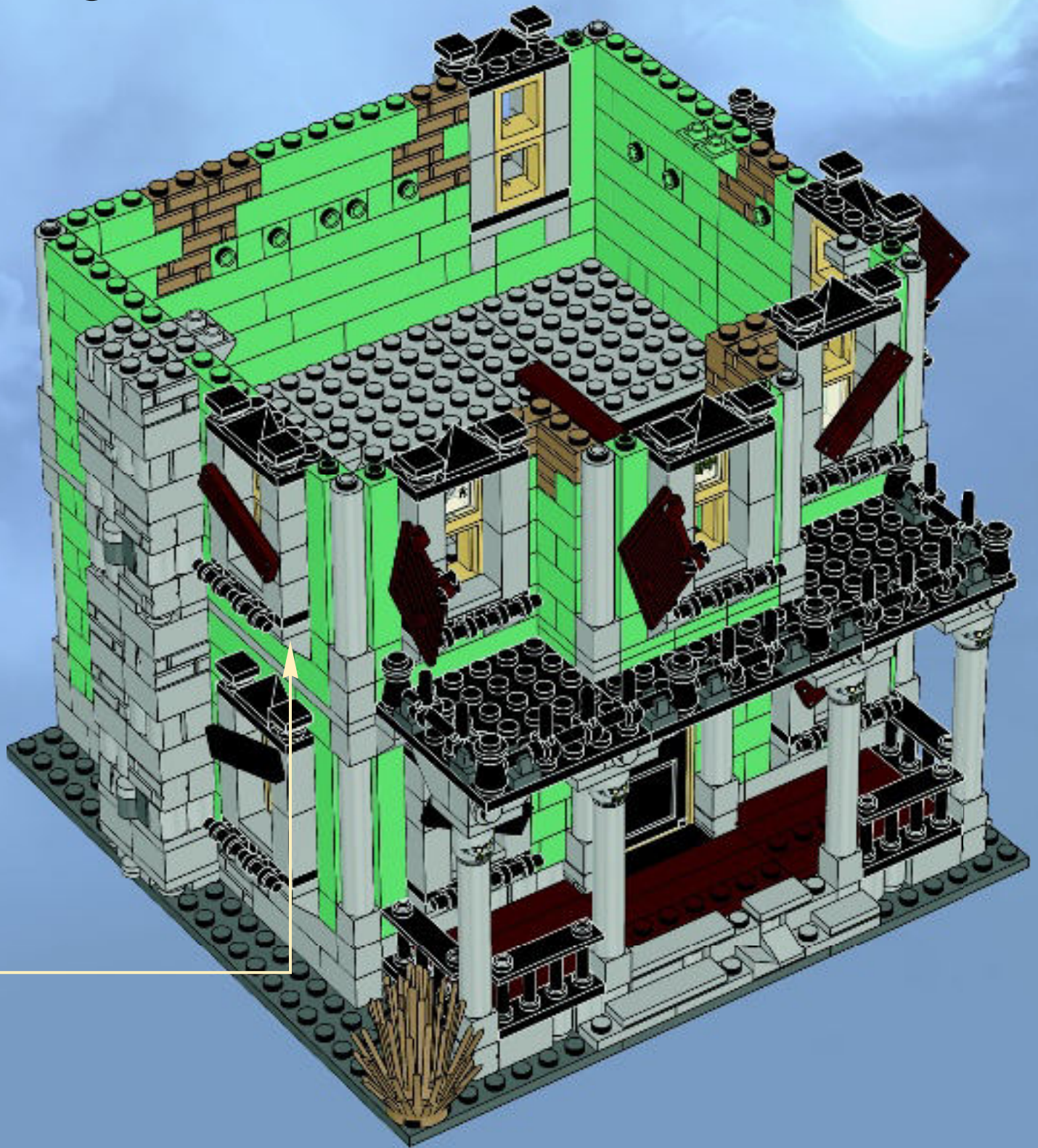



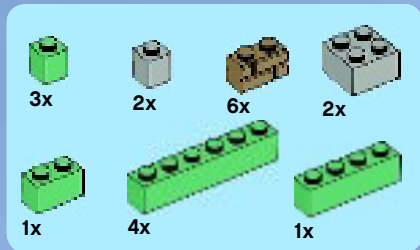

88

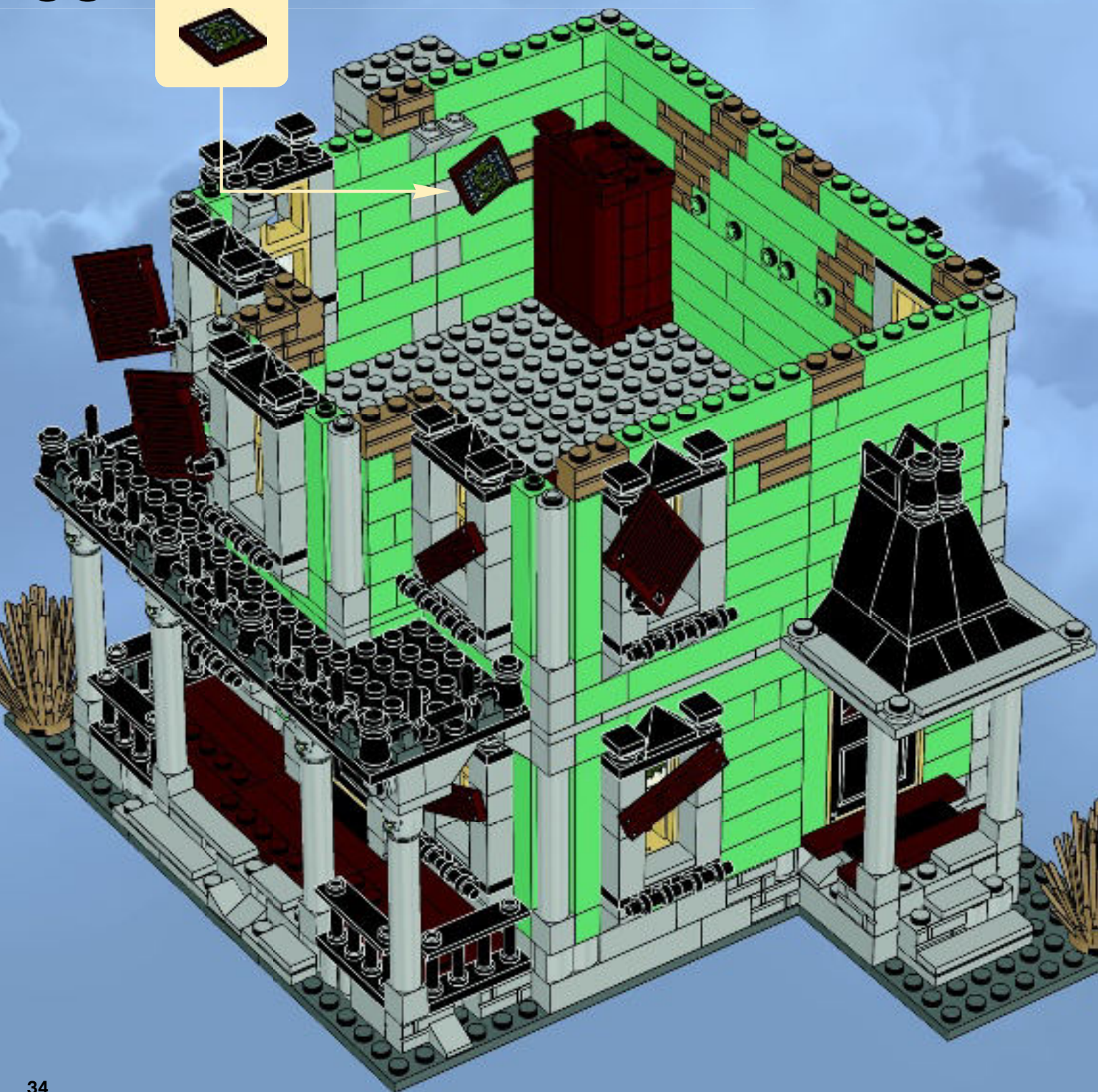



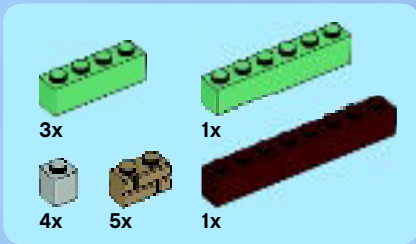

89

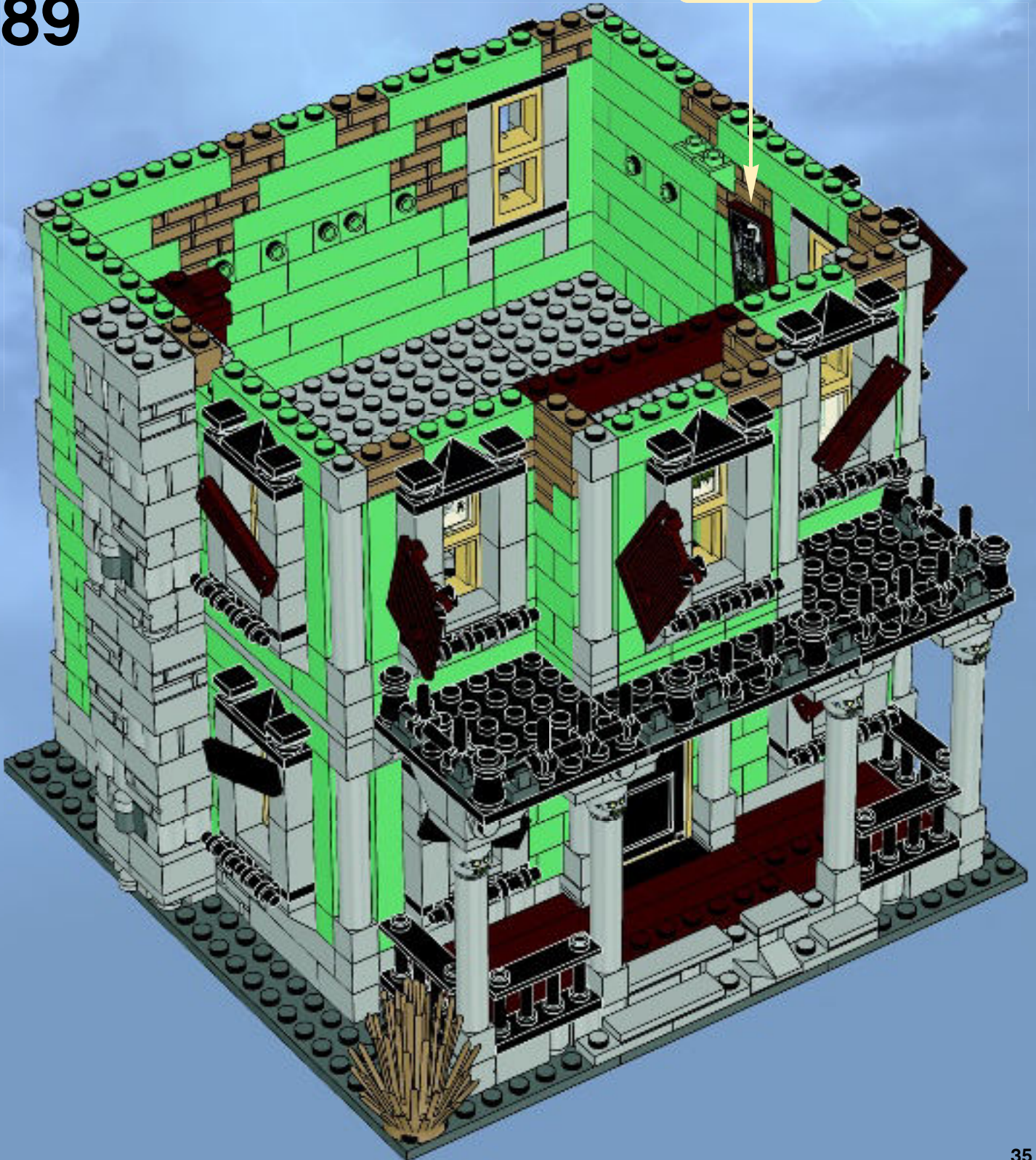



90

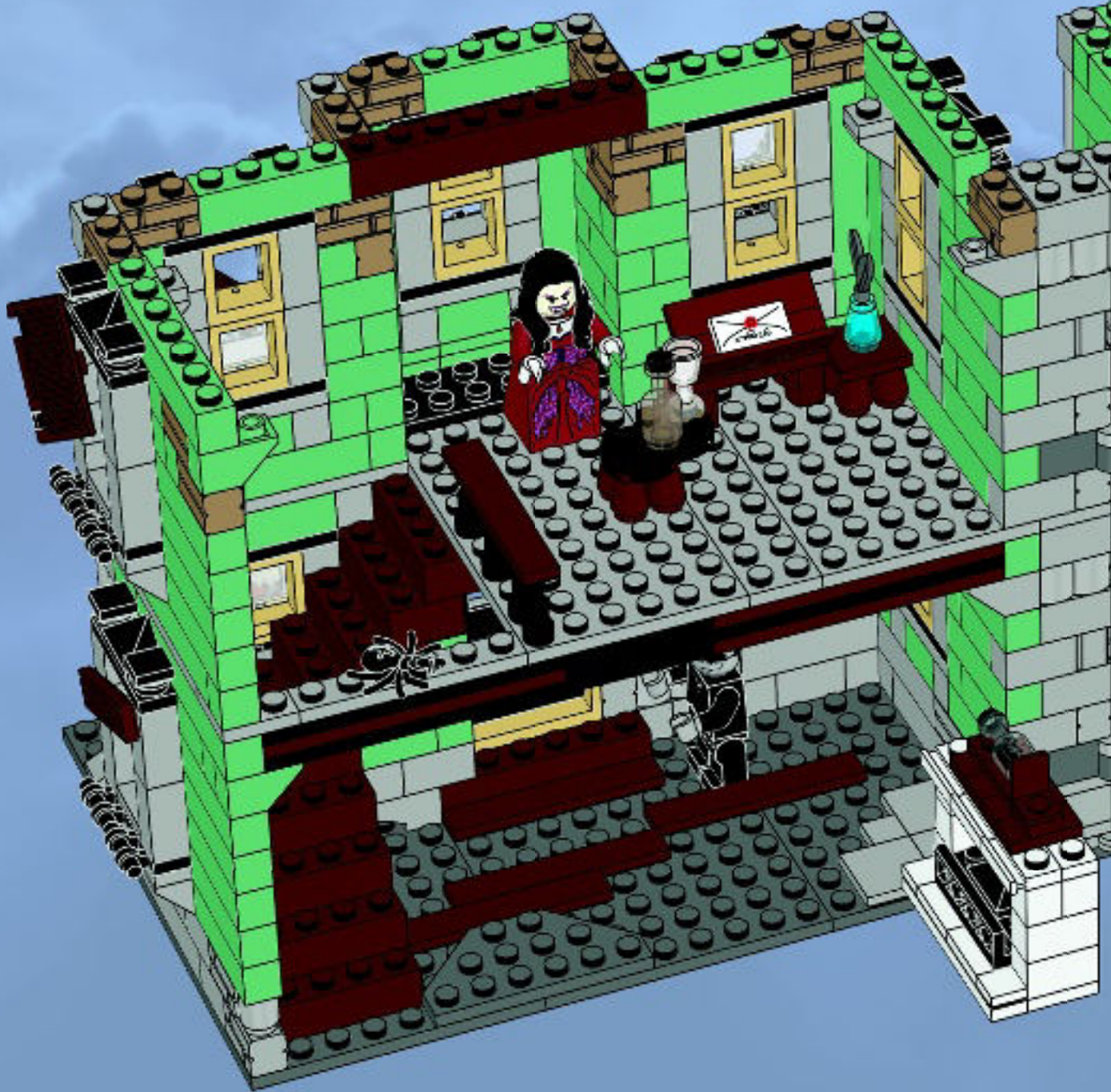



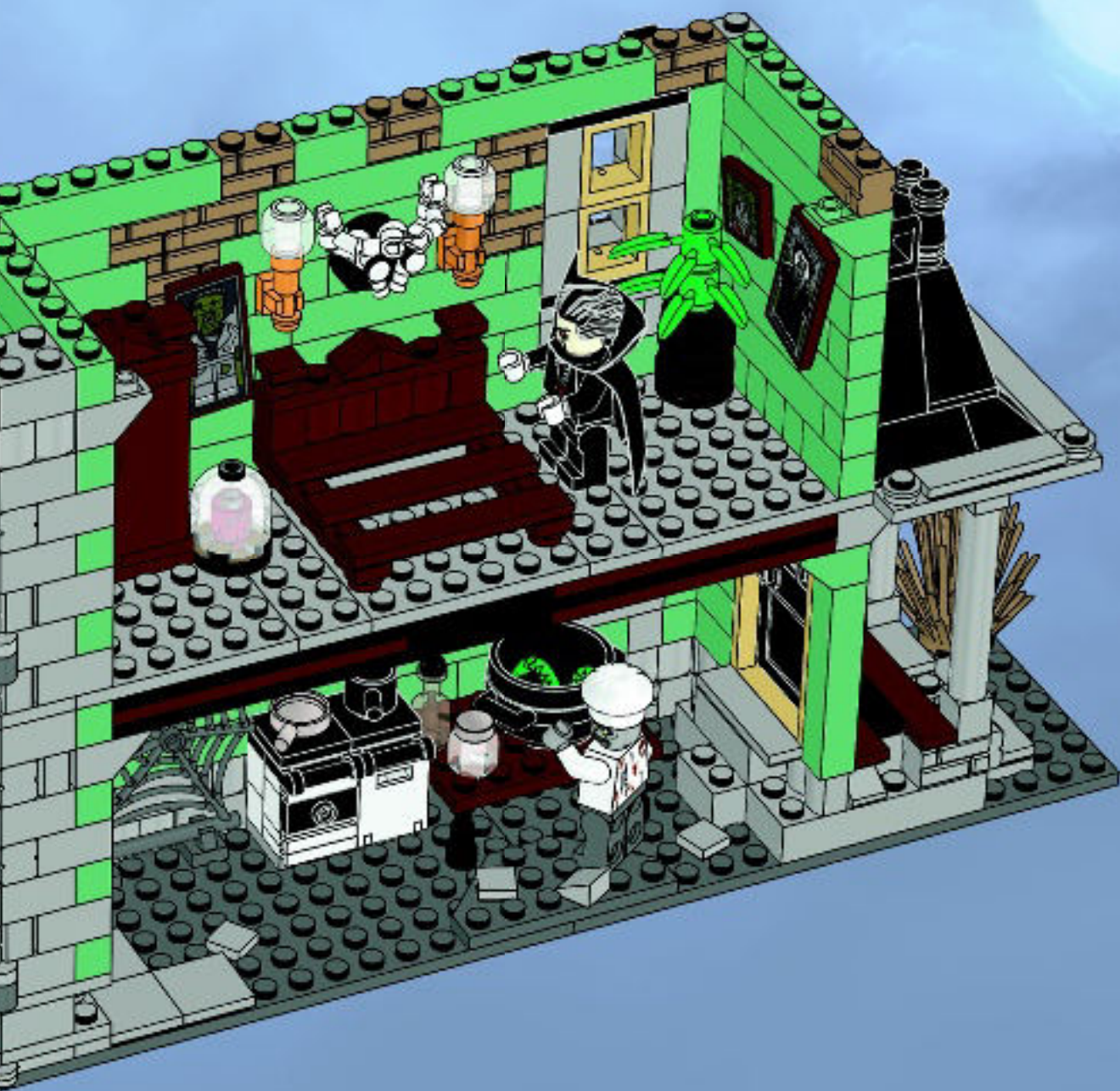



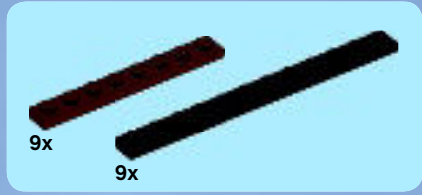

1

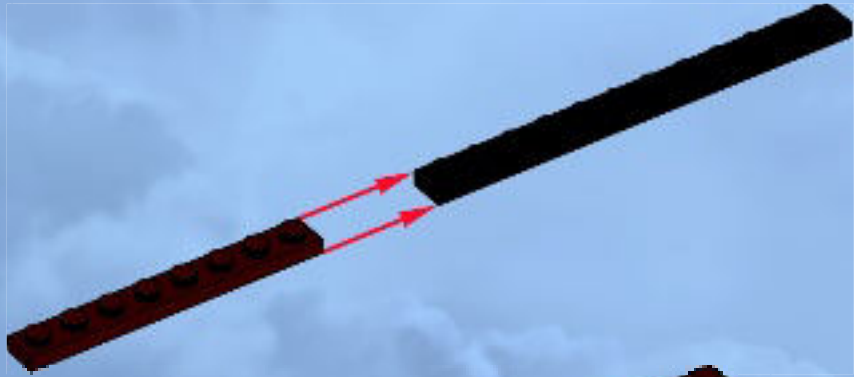

2



3



3x

91

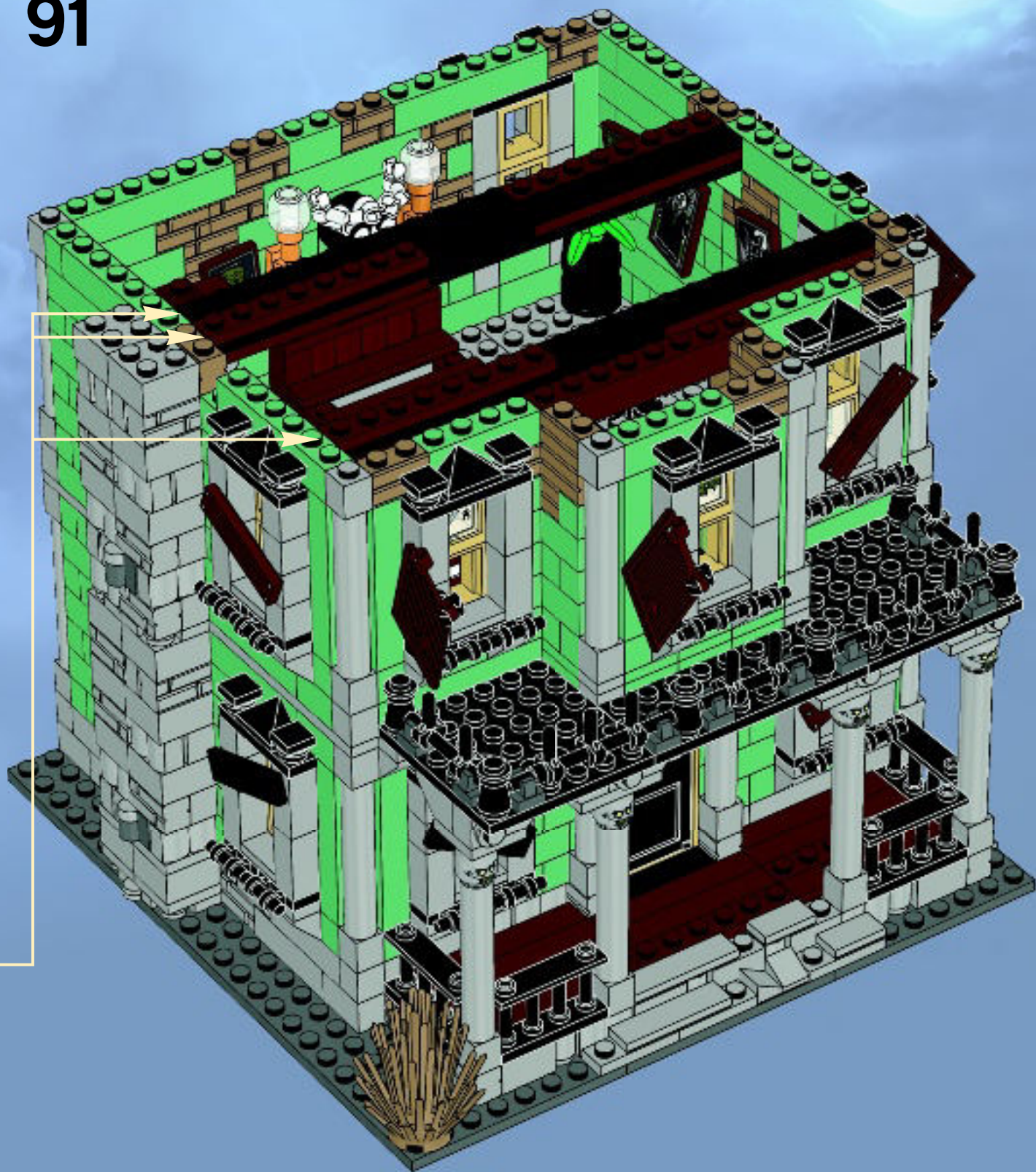







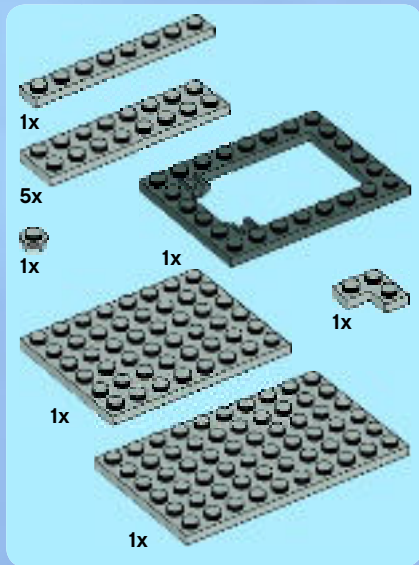

93

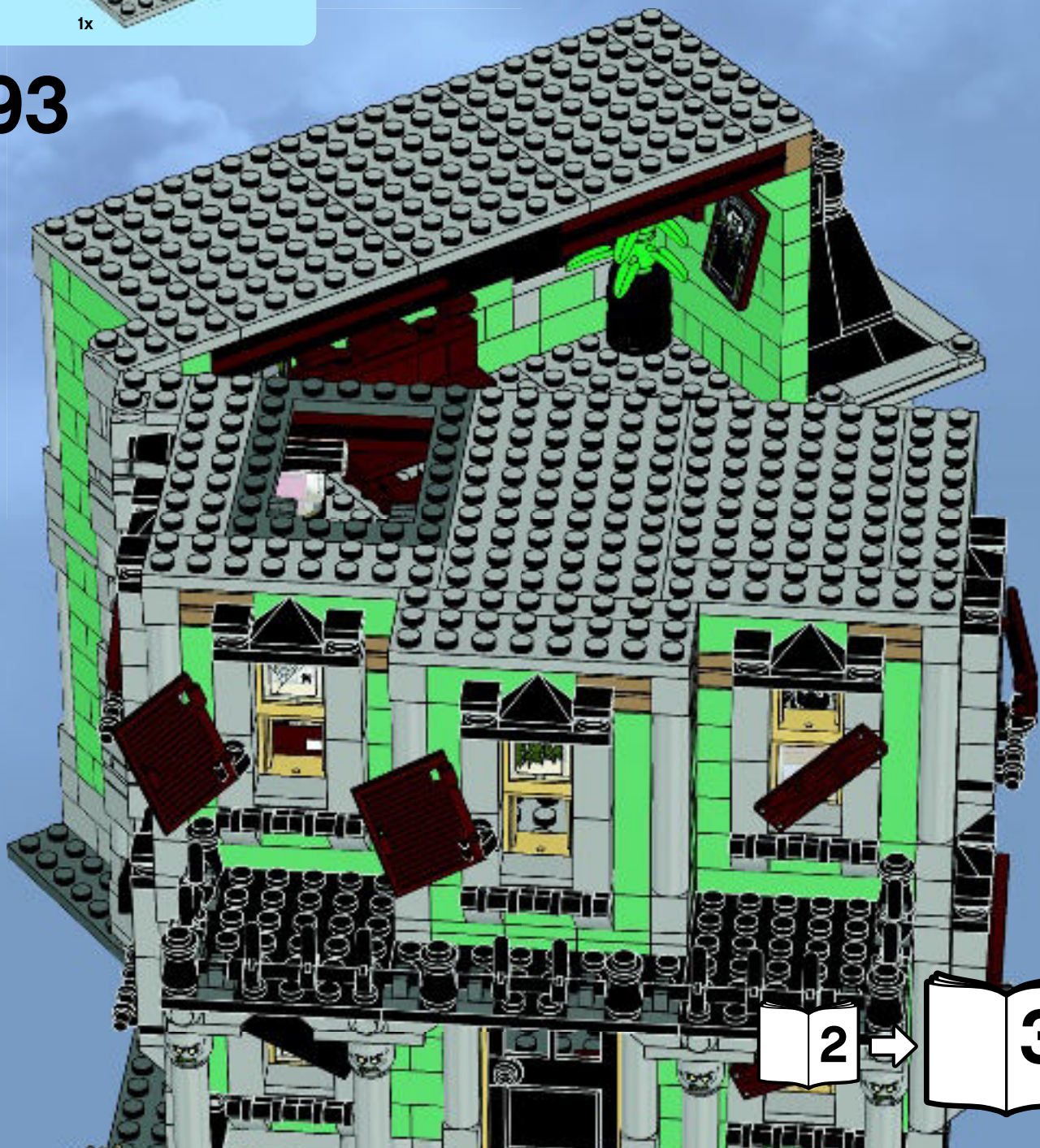





# MONSTER FIGHTERS



9461



9462



9463



9464



9466



9467



9468



LEGO

# MONSTER FIGHTERS

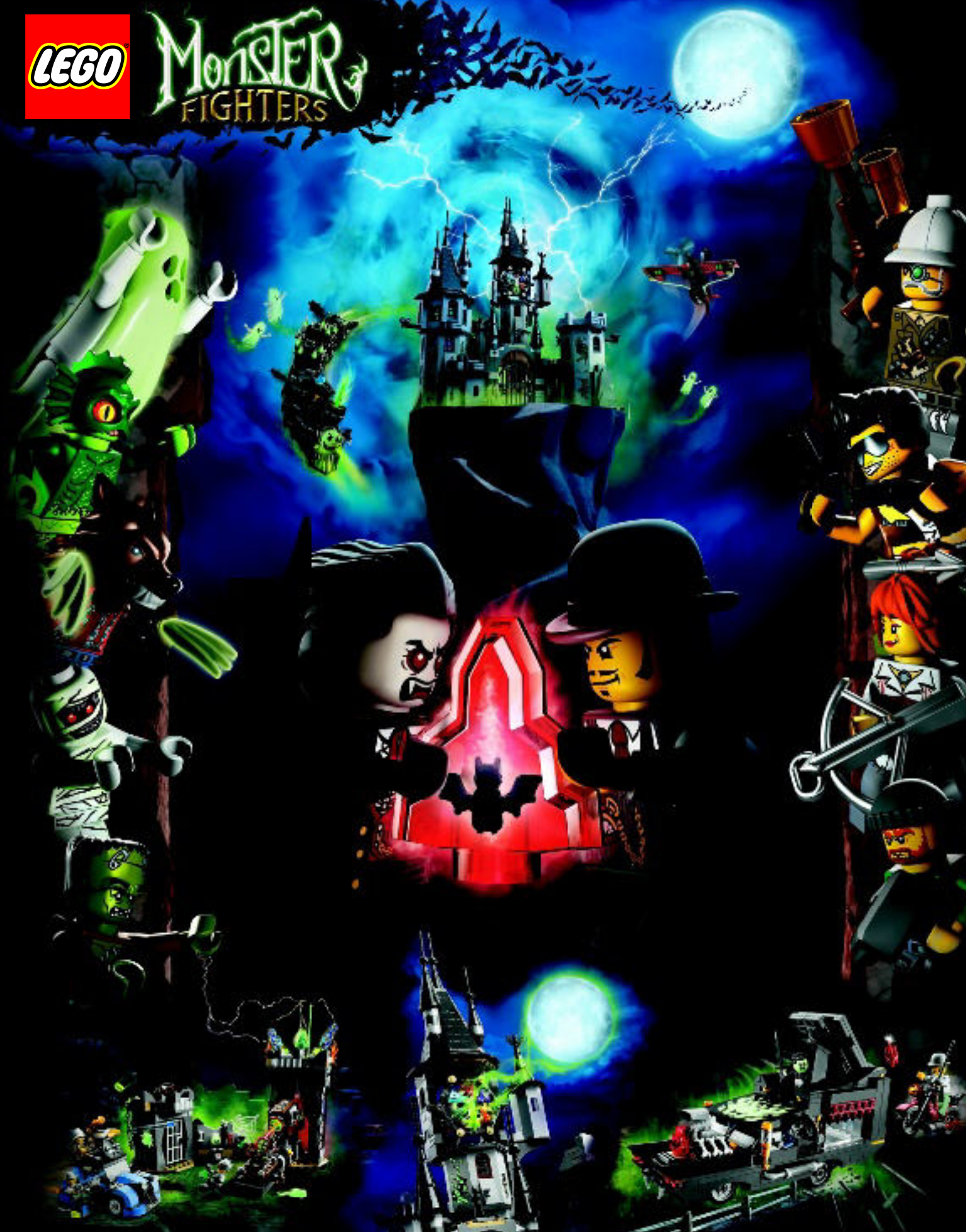



1



club™

FREE\*! GRATIS! GRATUIT!

[www.LEGOclub.com/Max](http://www.LEGOclub.com/Max)

[www.LEGOclub.com/Max](http://www.LEGOclub.com/Max)

2



3



©2012 The LEGO Group.

\*Paid subscription in Australia and New Zealand.

\*Abonnement payant en Australie et Nouvelle-Zélande.

LEGO and the LEGO logo are trademarks of the/ sont des marques de commerce de/son marcas registradas de LEGO Group. ©2012 The LEGO Group.

 [www.LEGO.com](http://www.LEGO.com)

6030855 / 6030865





# MONSTER FIGHTERS

10228





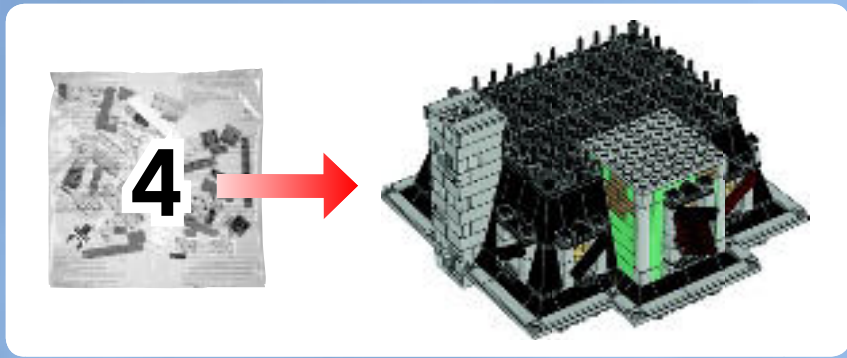

- 2x
- 6x
- 12x

94

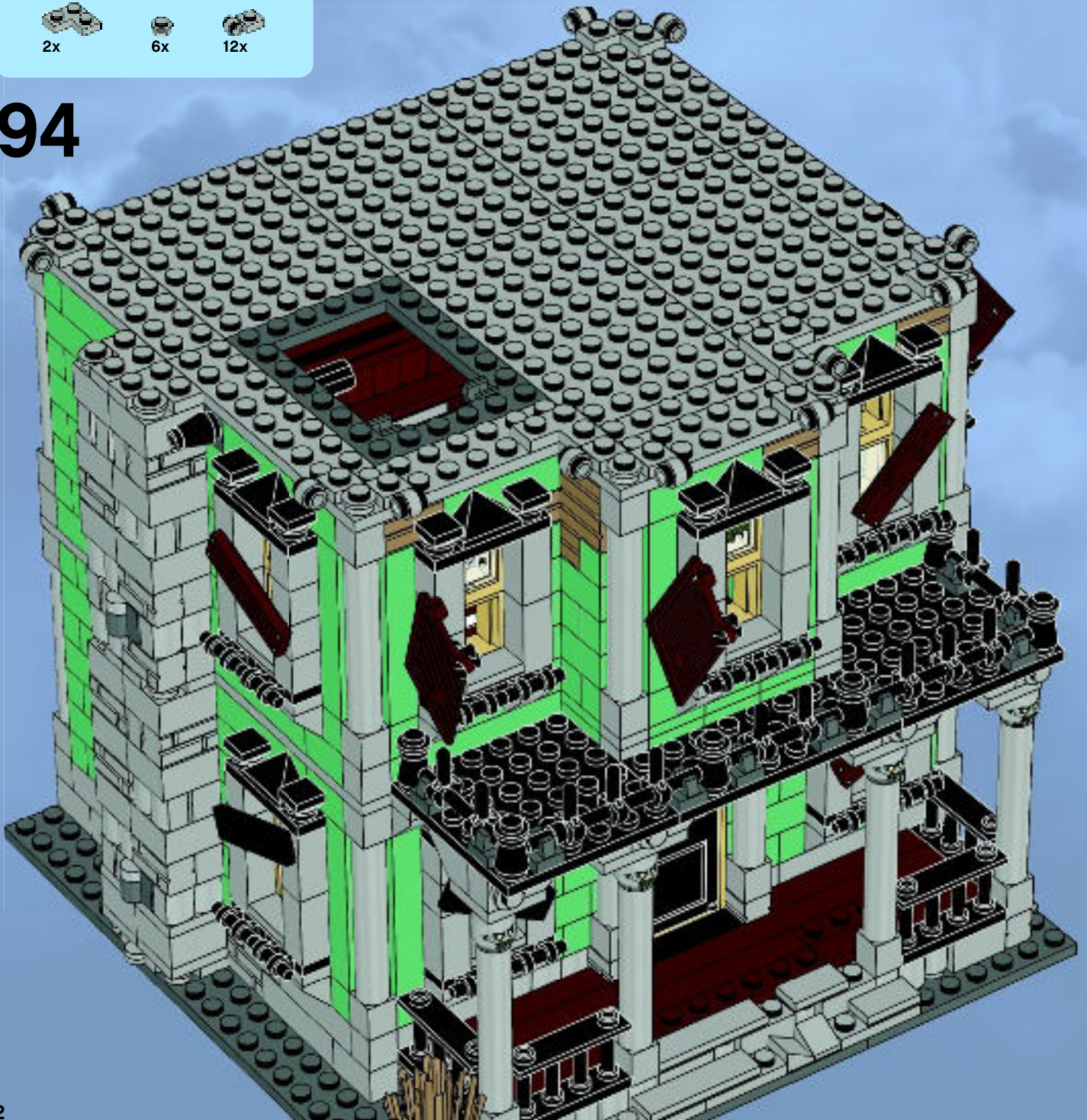





27x

# 95

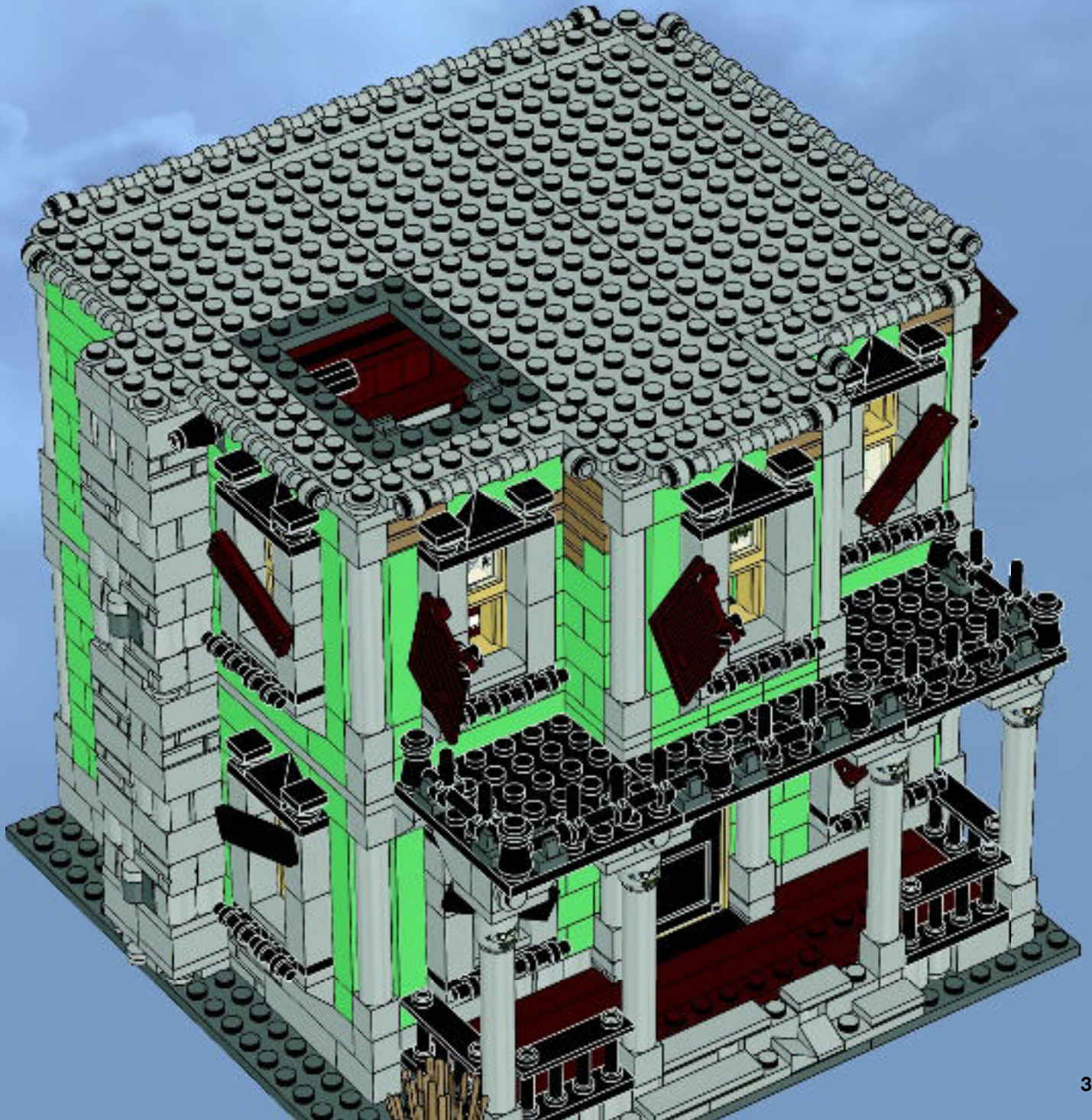



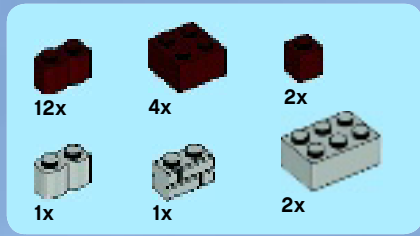

# 96

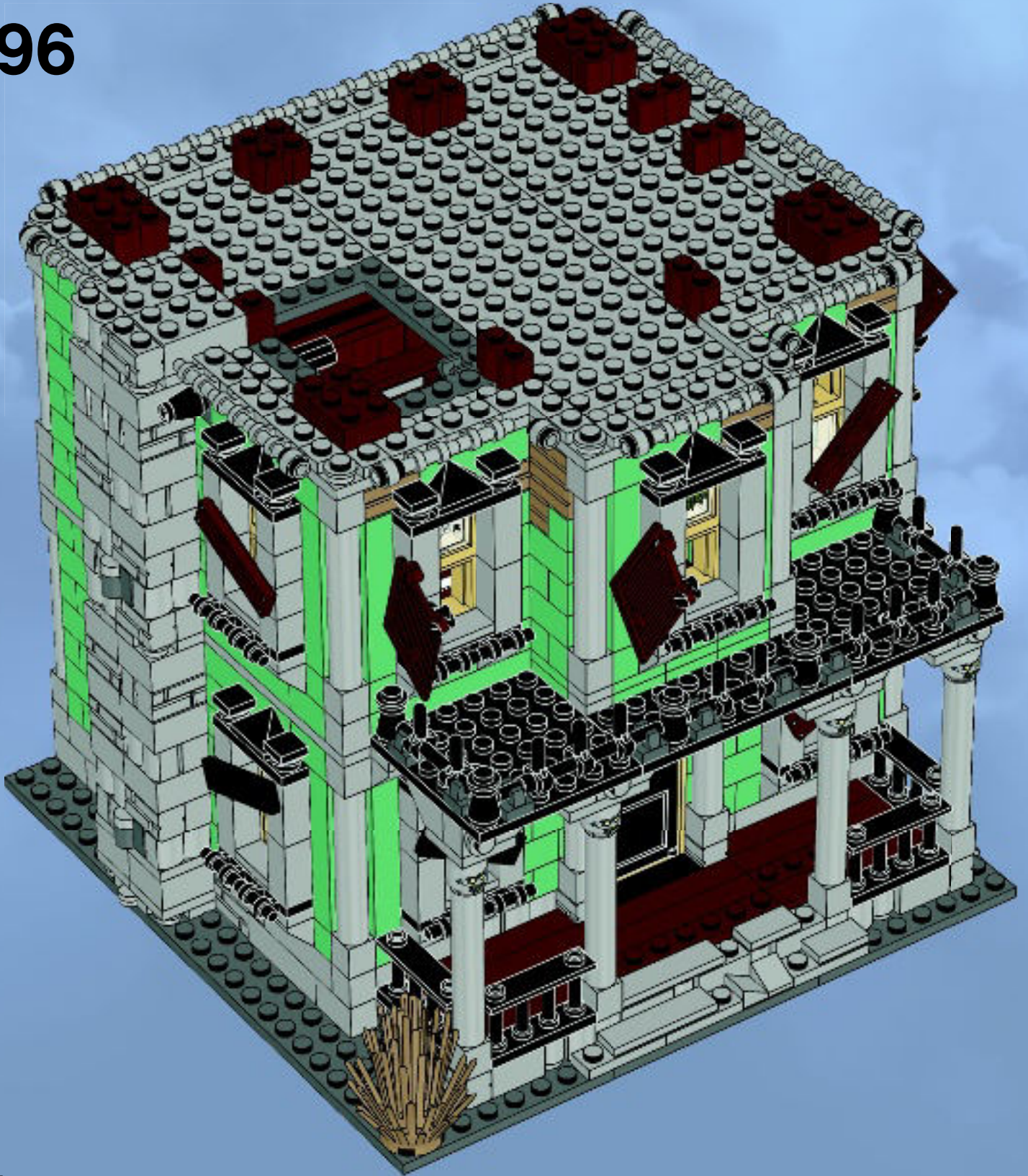



1x

1



4x

2



4x

3

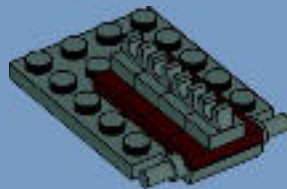



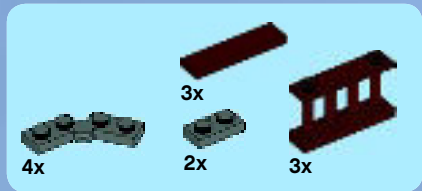

# 4

1  
2  
3  
4  
5  
6  
7

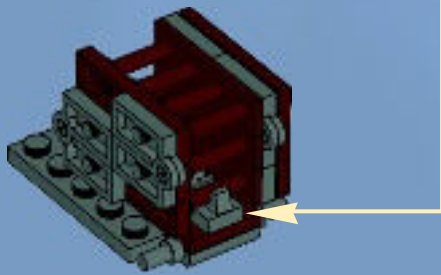

97

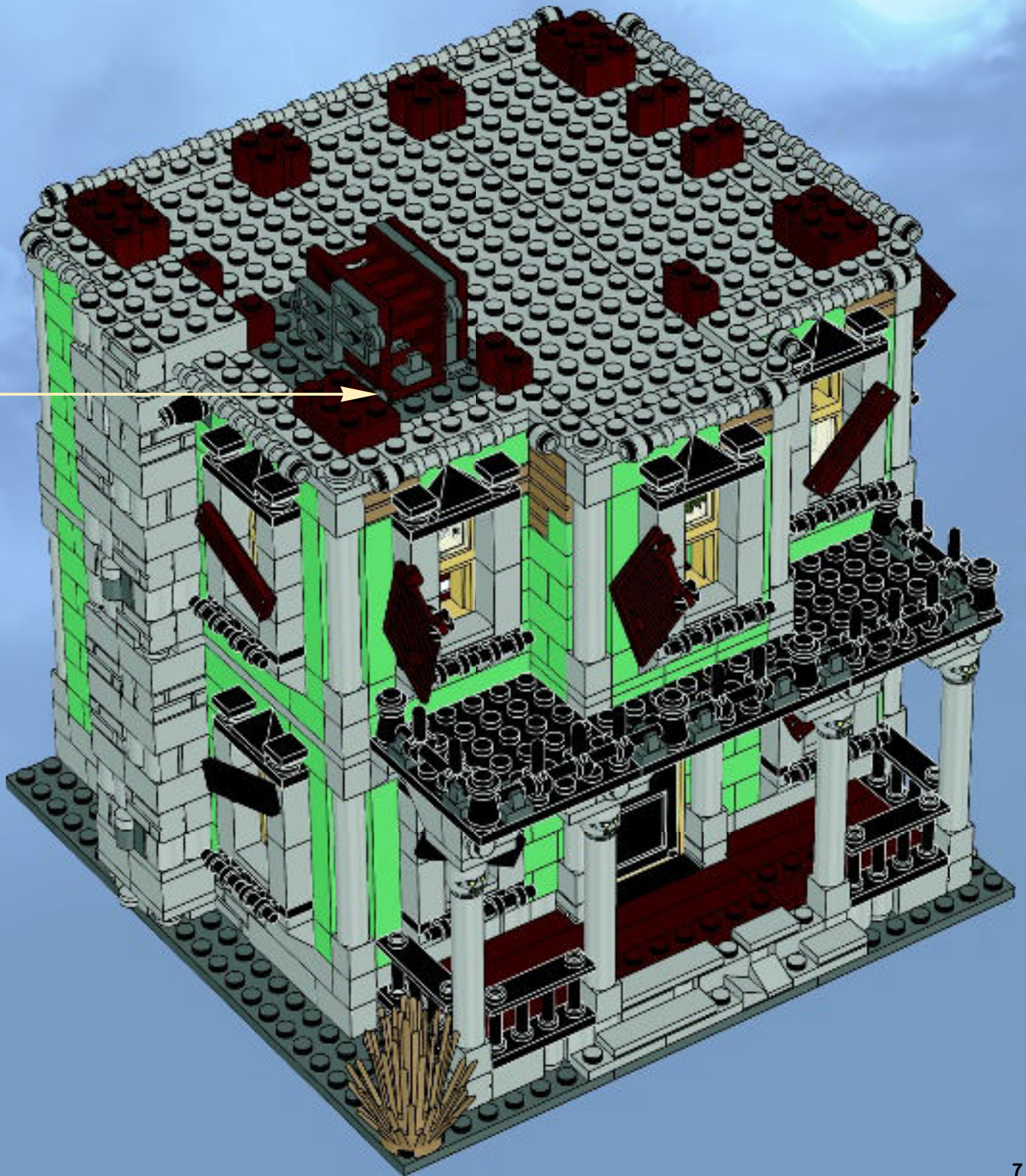



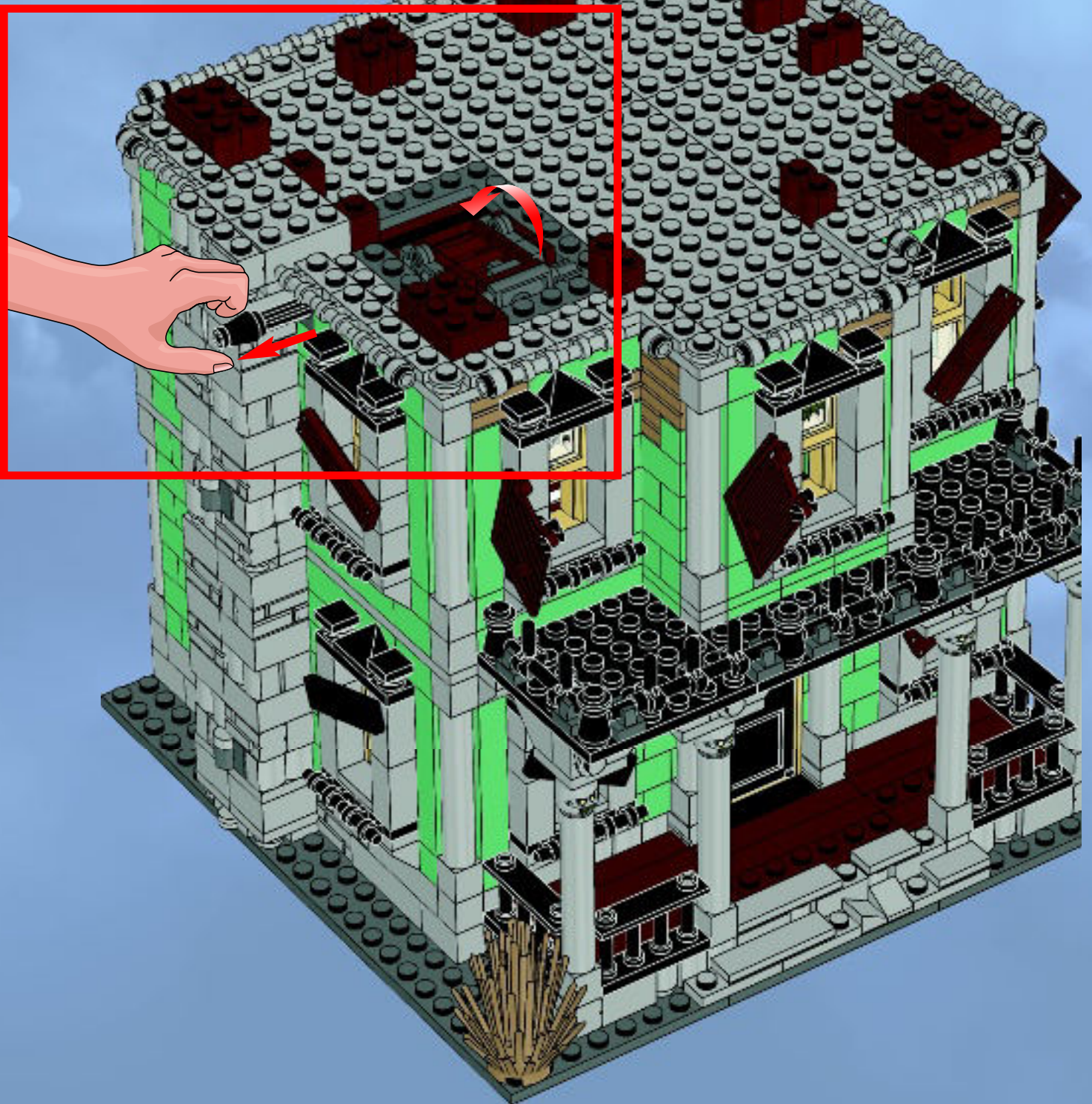



99

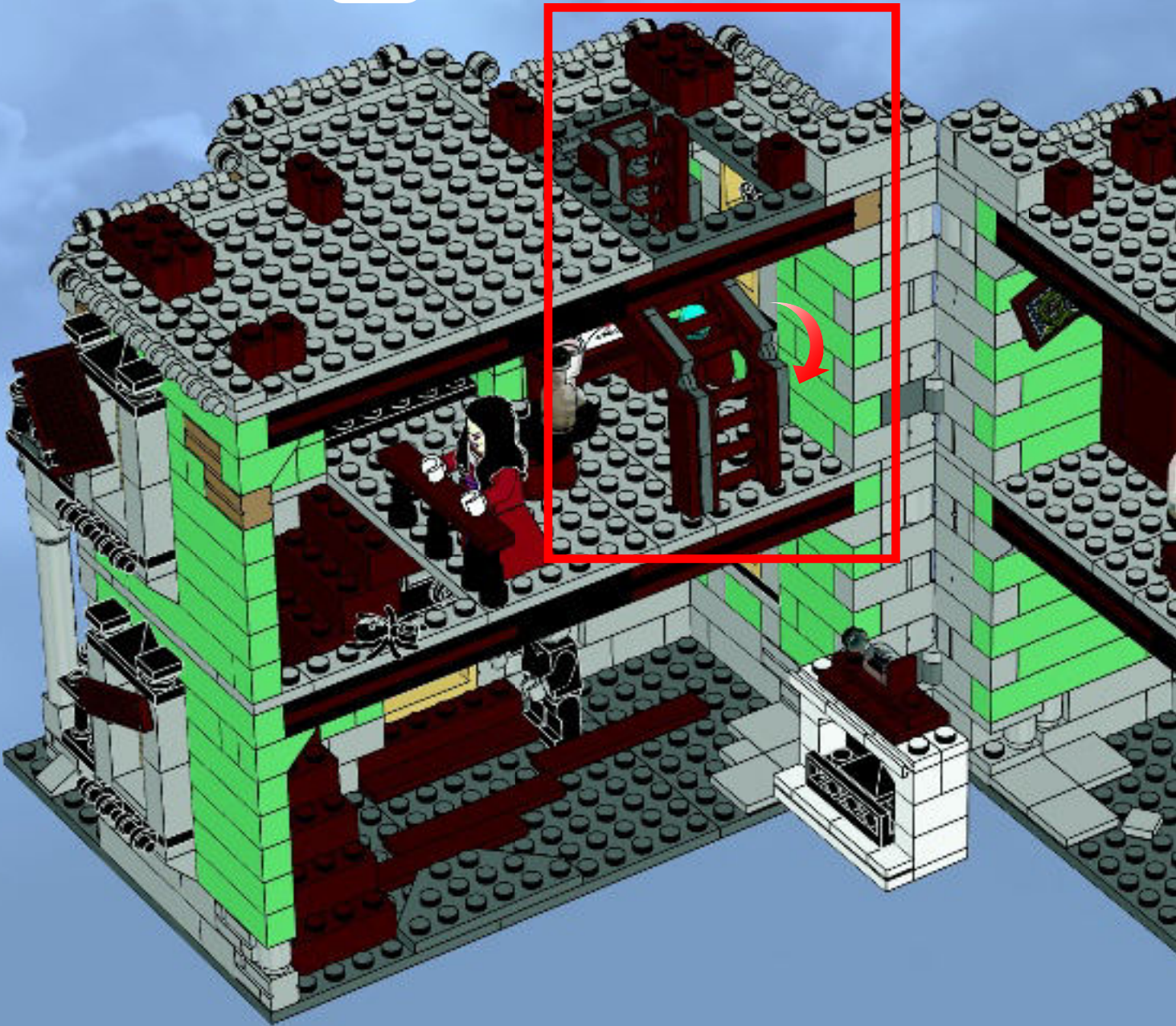





2x



6x



28x





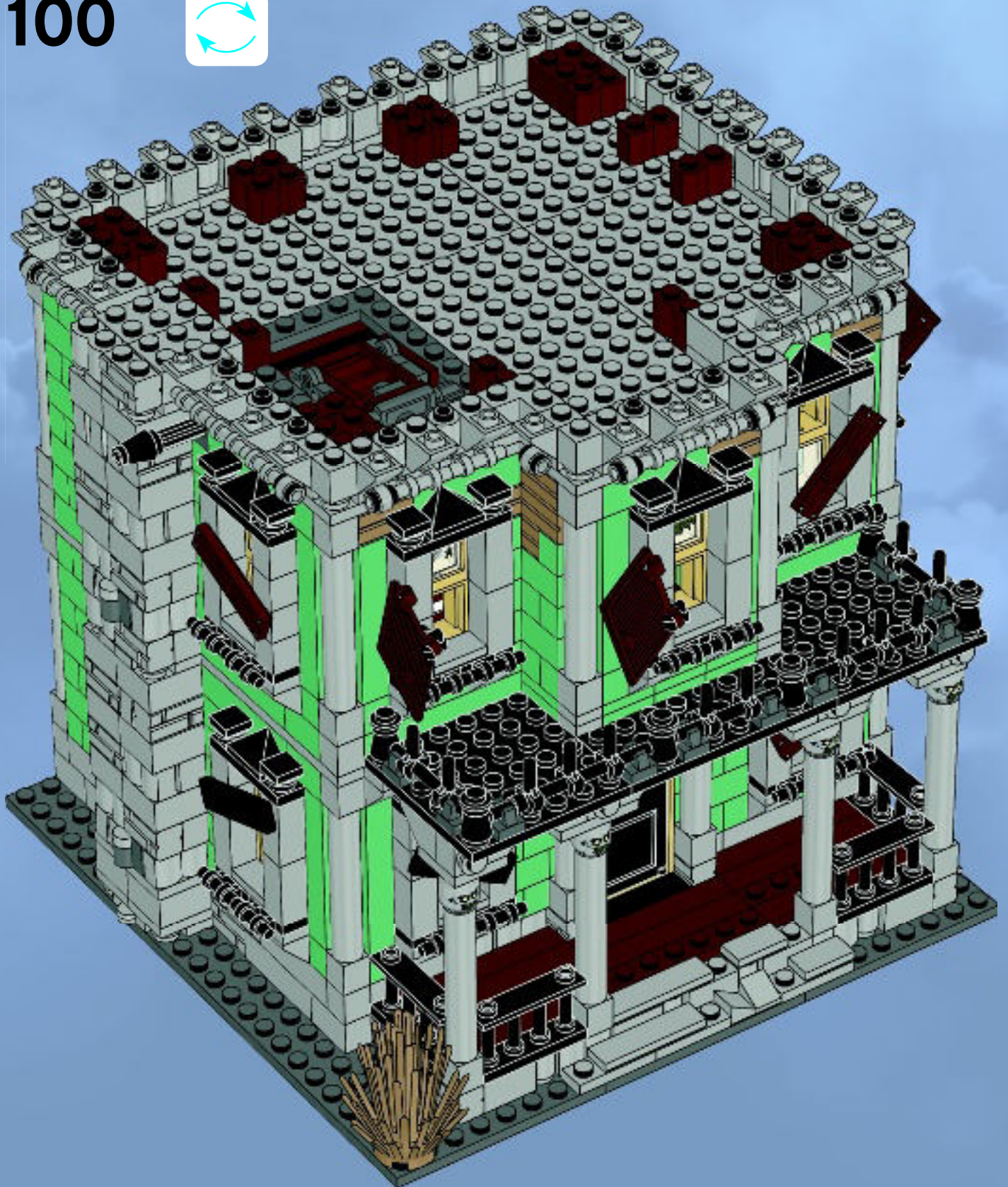

38x

# 100





	
4x	2x
	
7x	3x

# 101

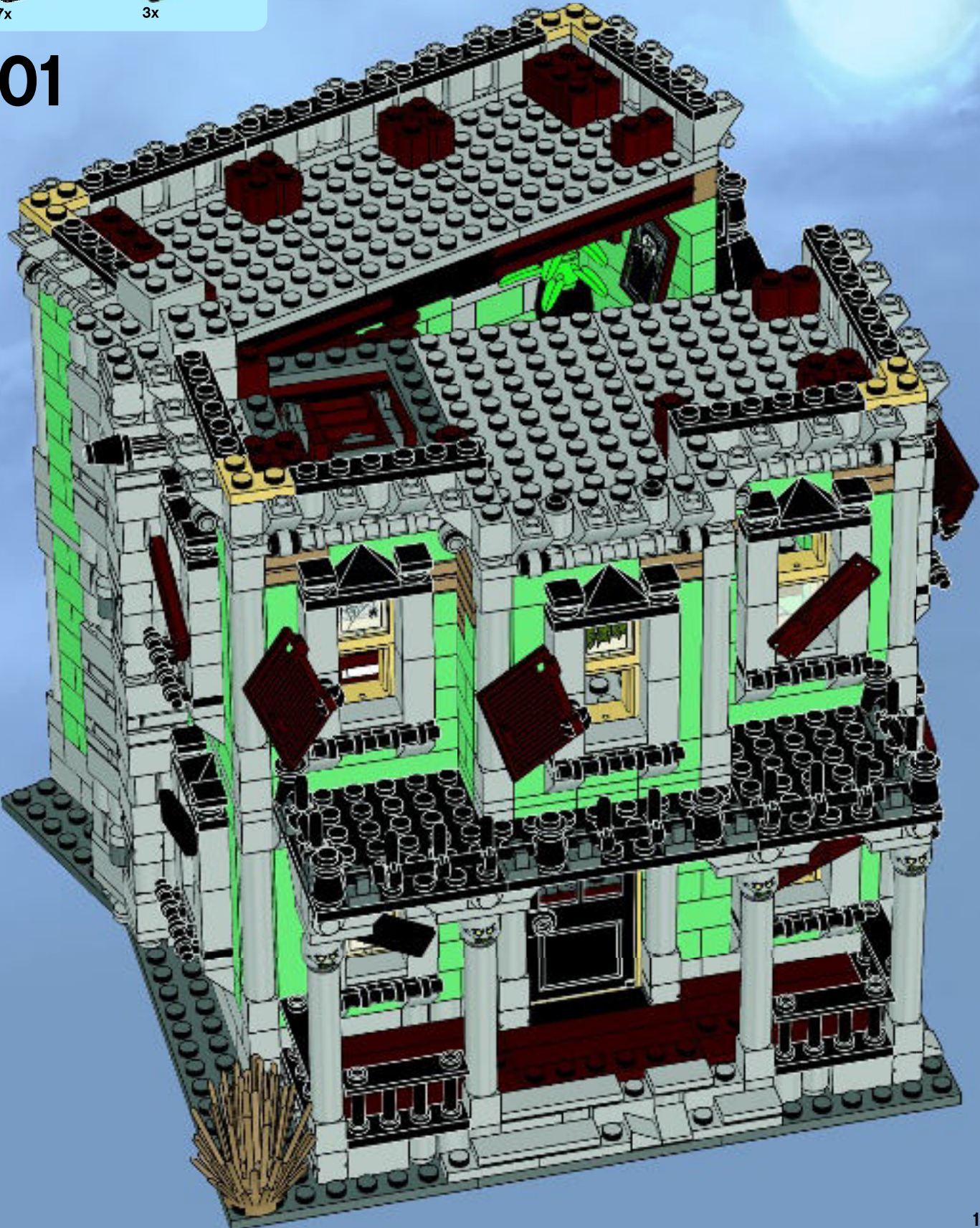



102

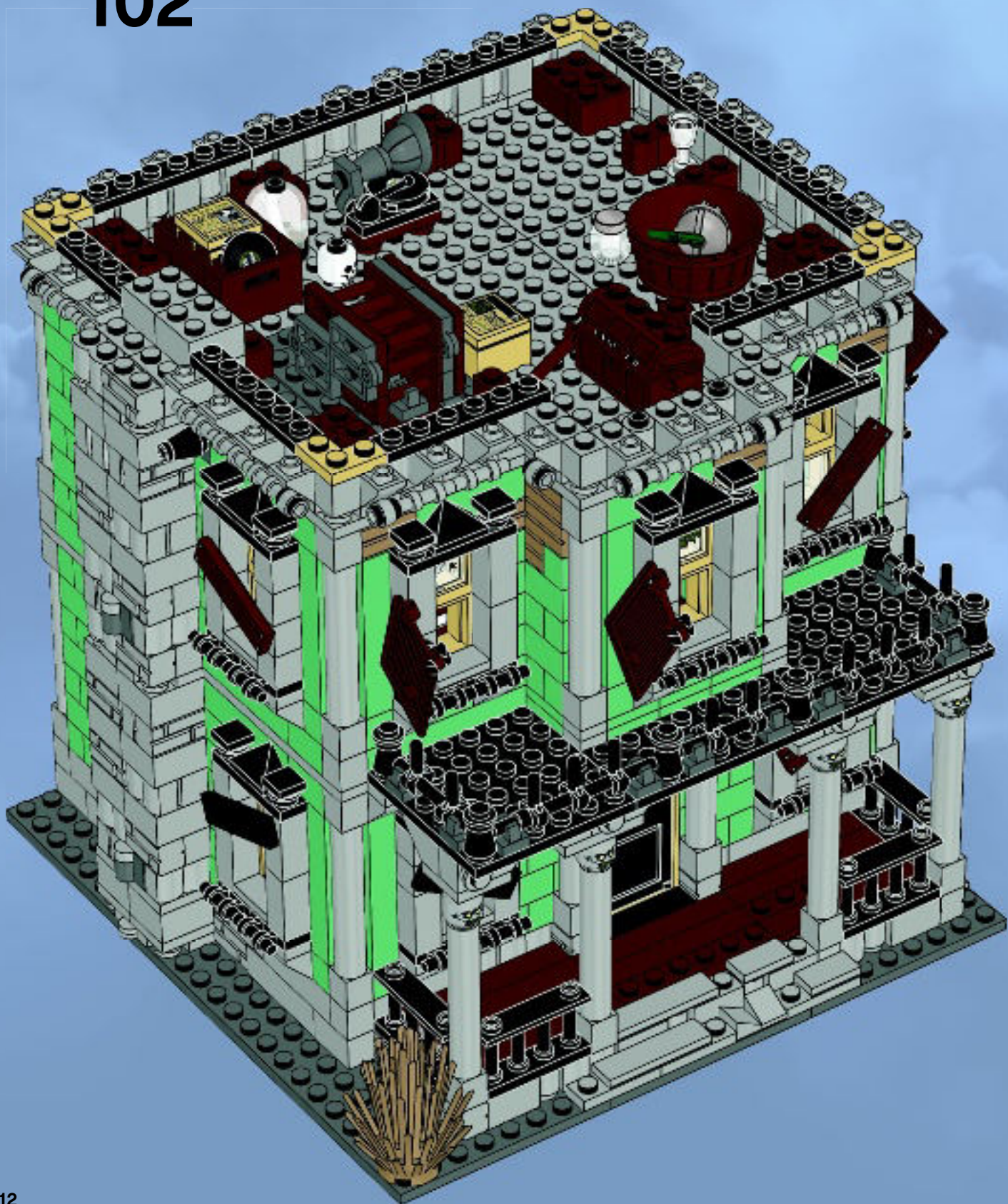





12x



4x



2x

# 103

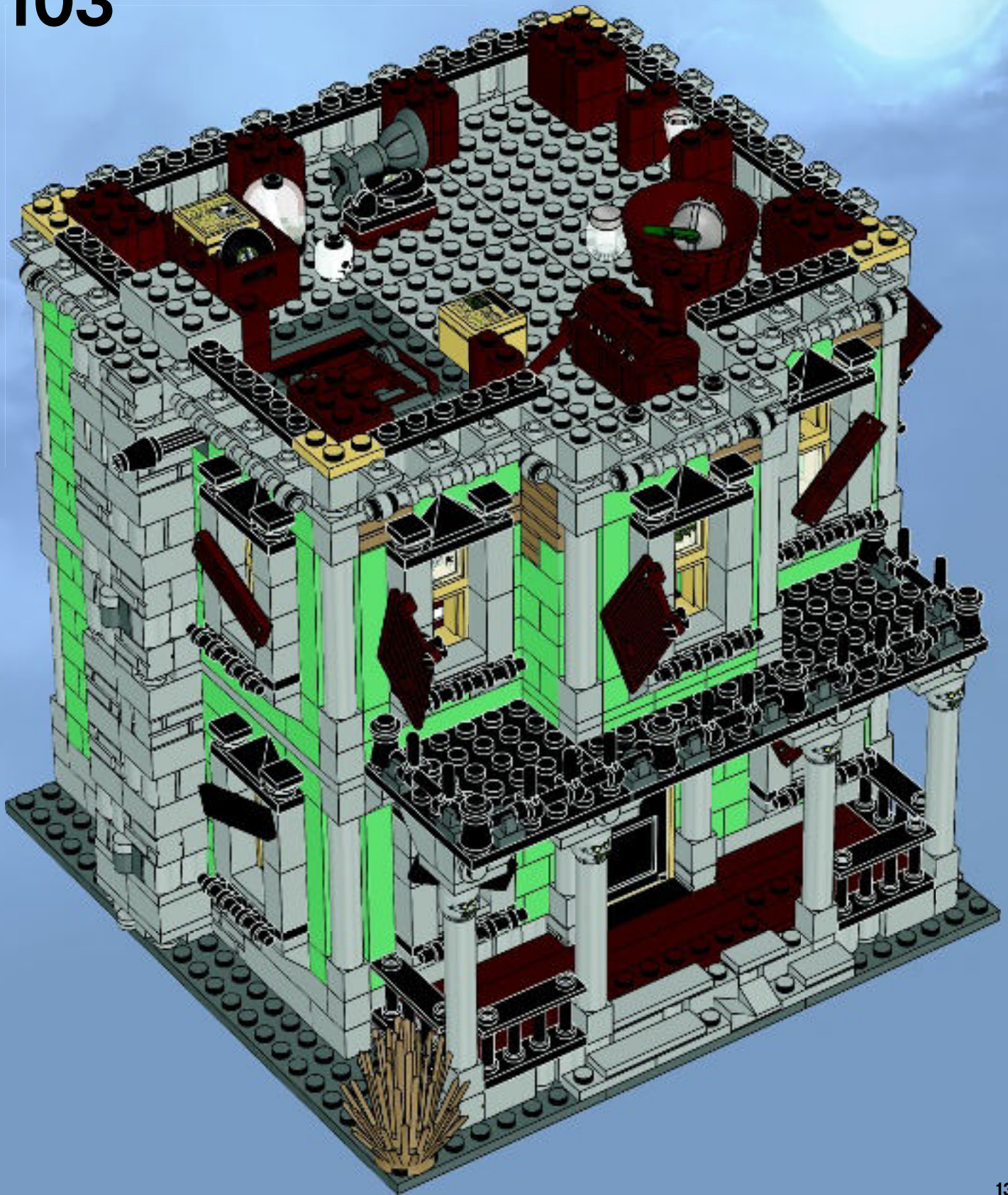



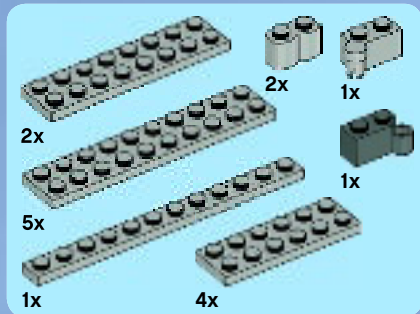

# 104

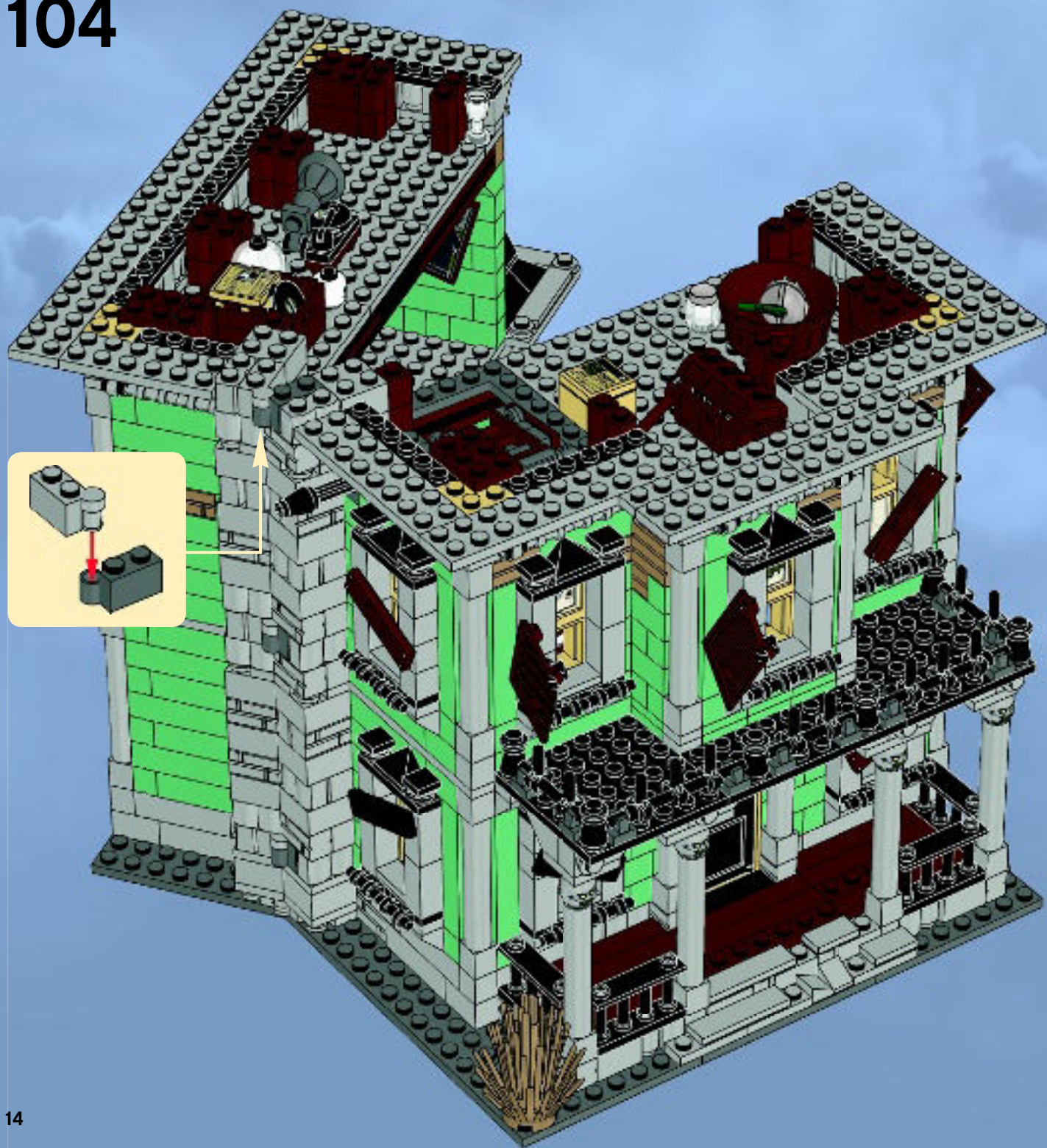





12x



4x



6x



6x



2x



2x

# 105









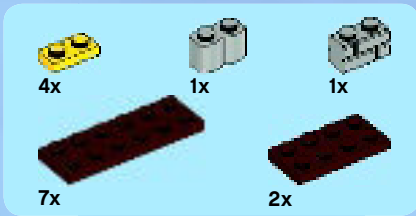

# 107

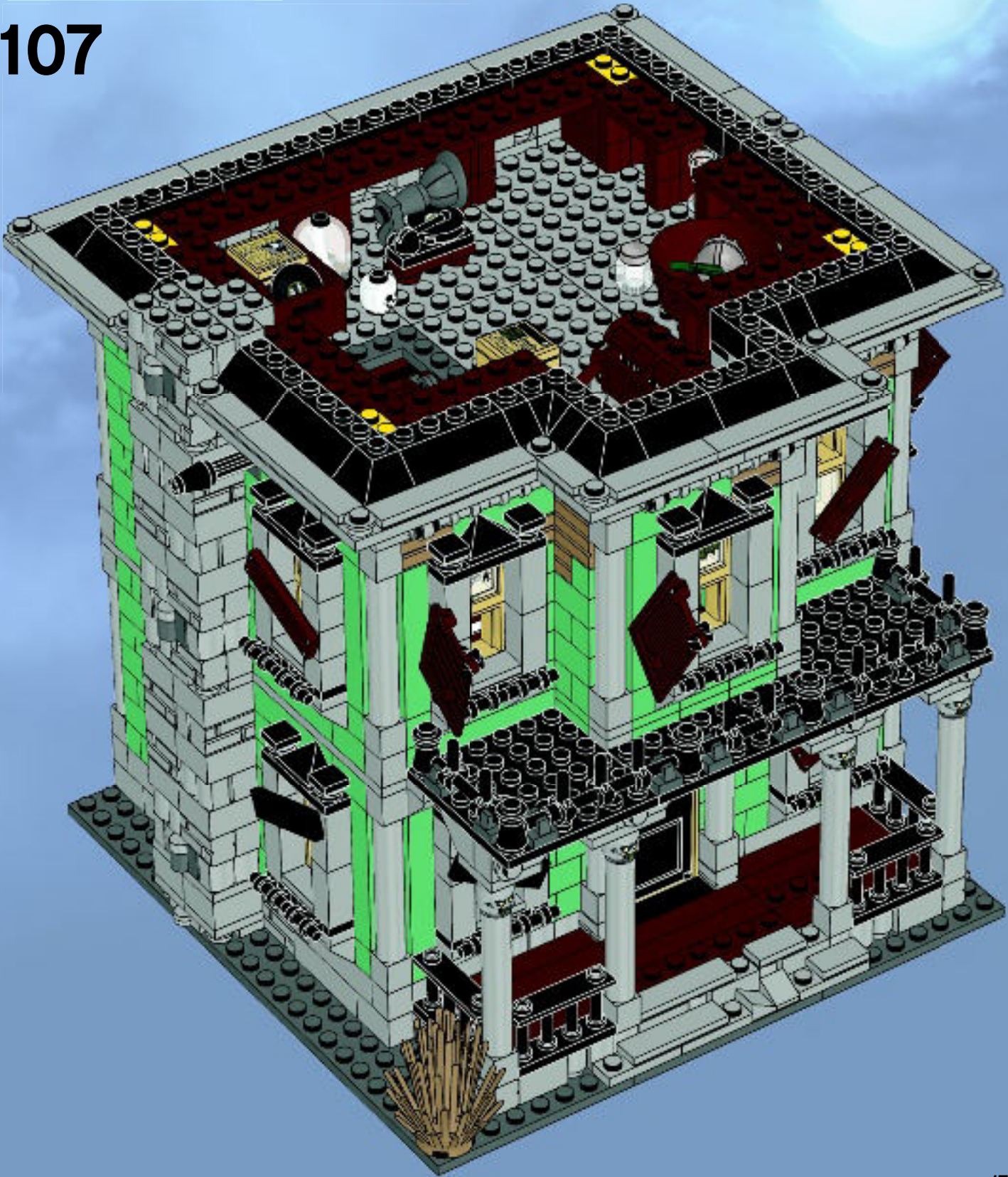





4x



7x



2x

# 108

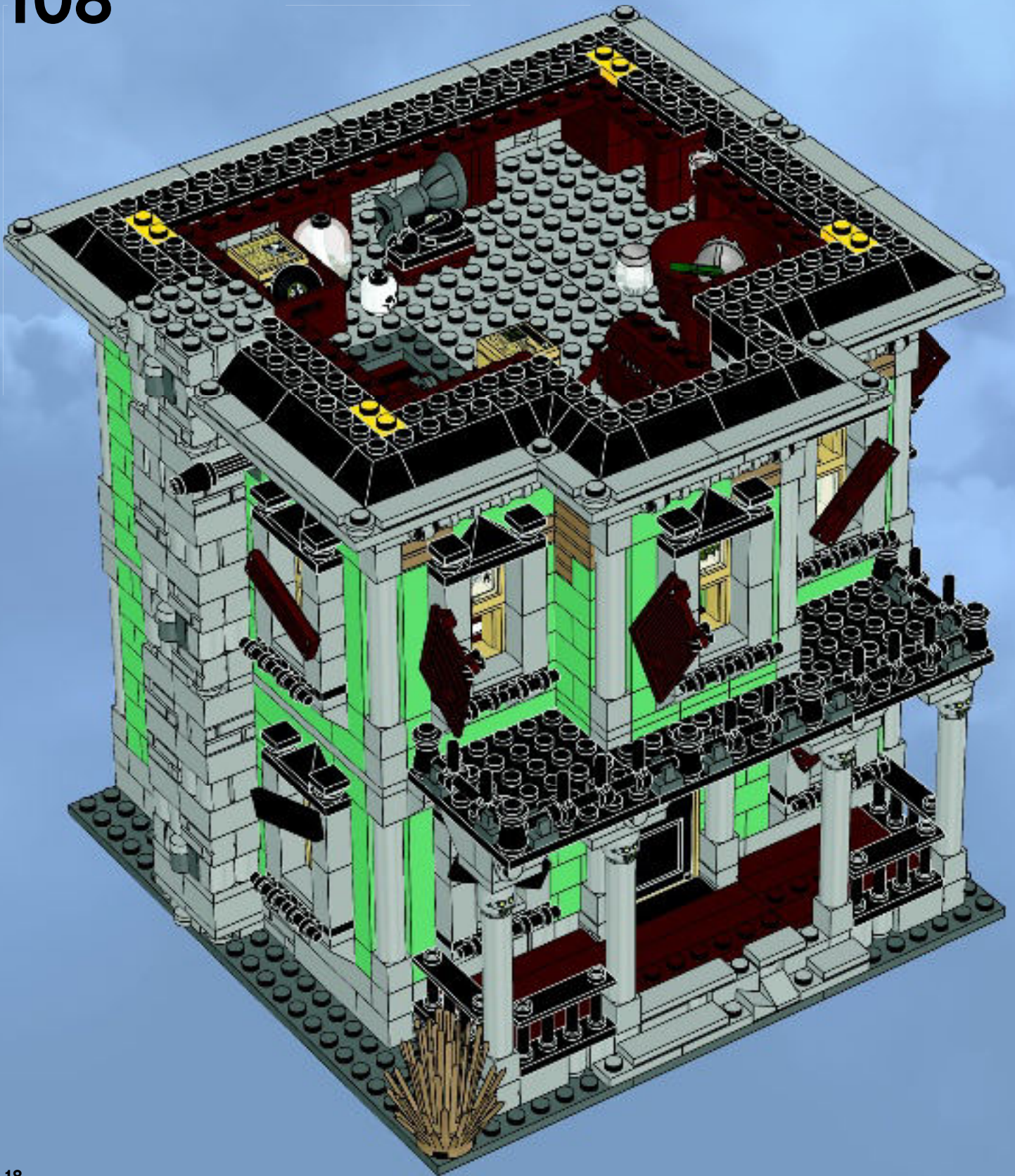





2x



6x



6x

# 109







5x



5x

# 110

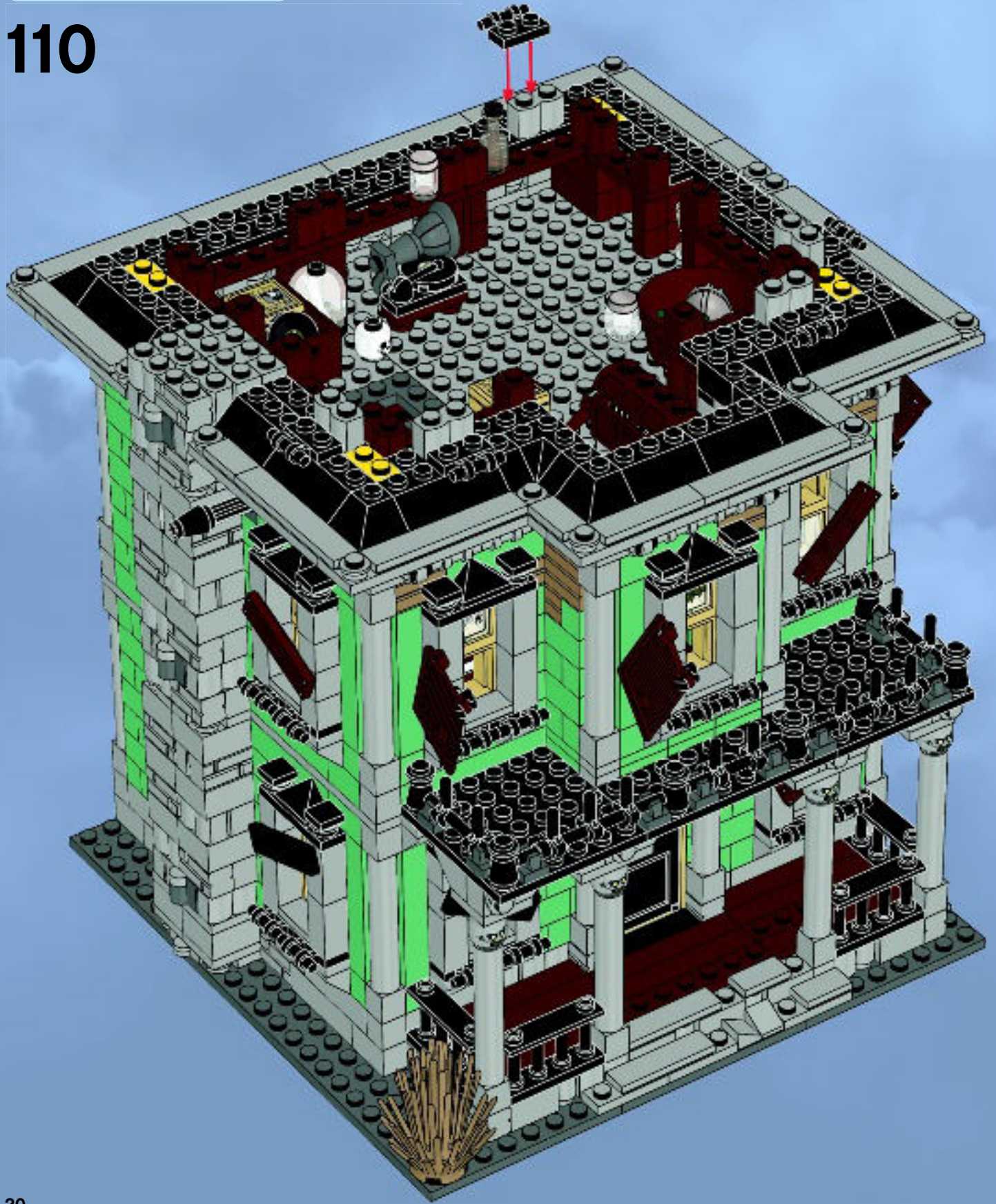





6x



6x

# 111

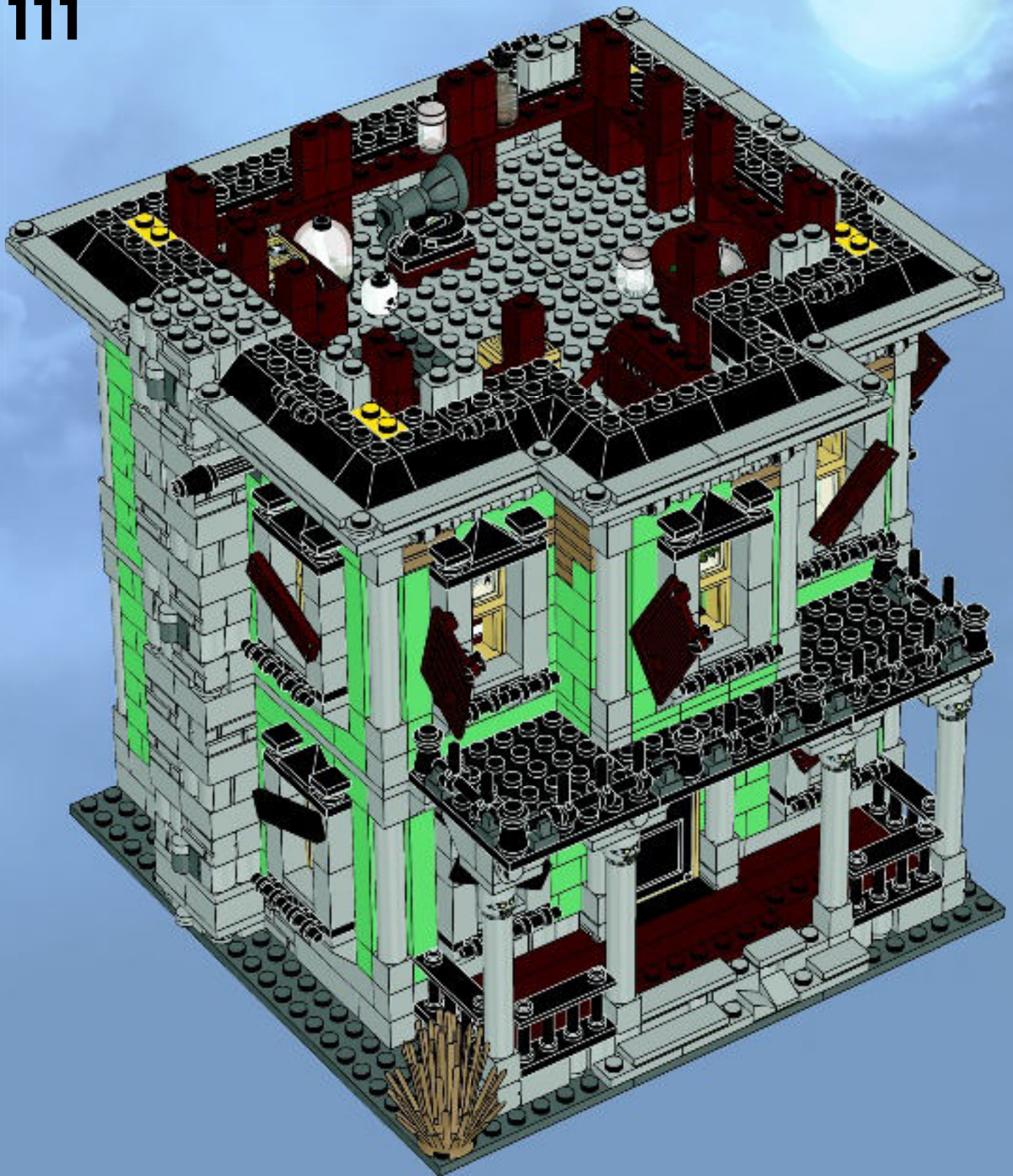



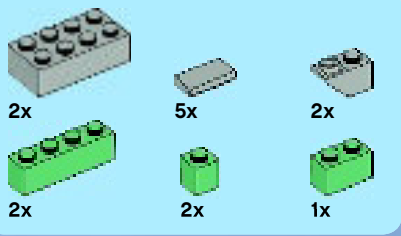

# 112

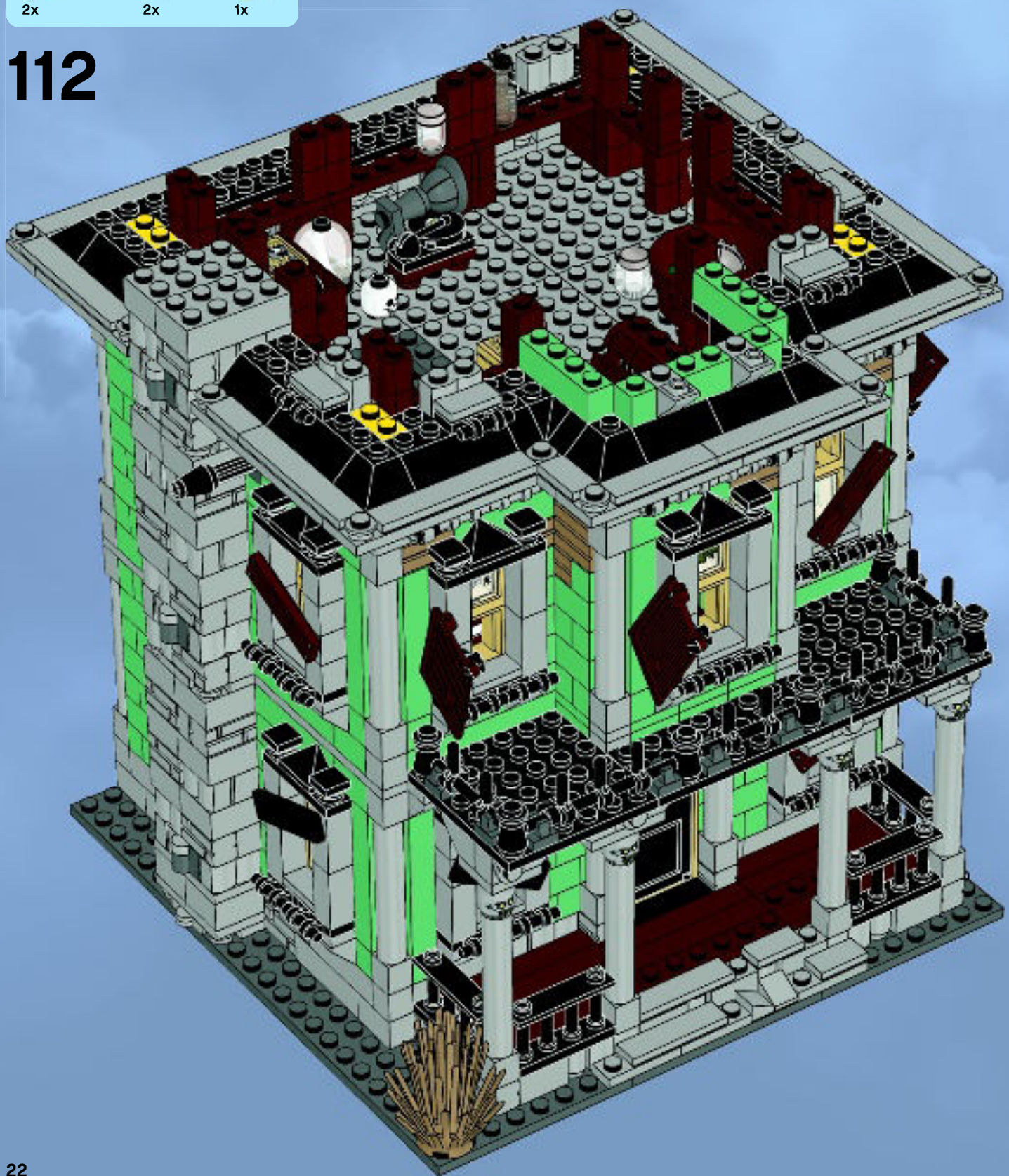



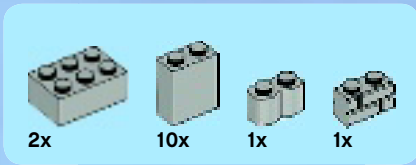

# 113

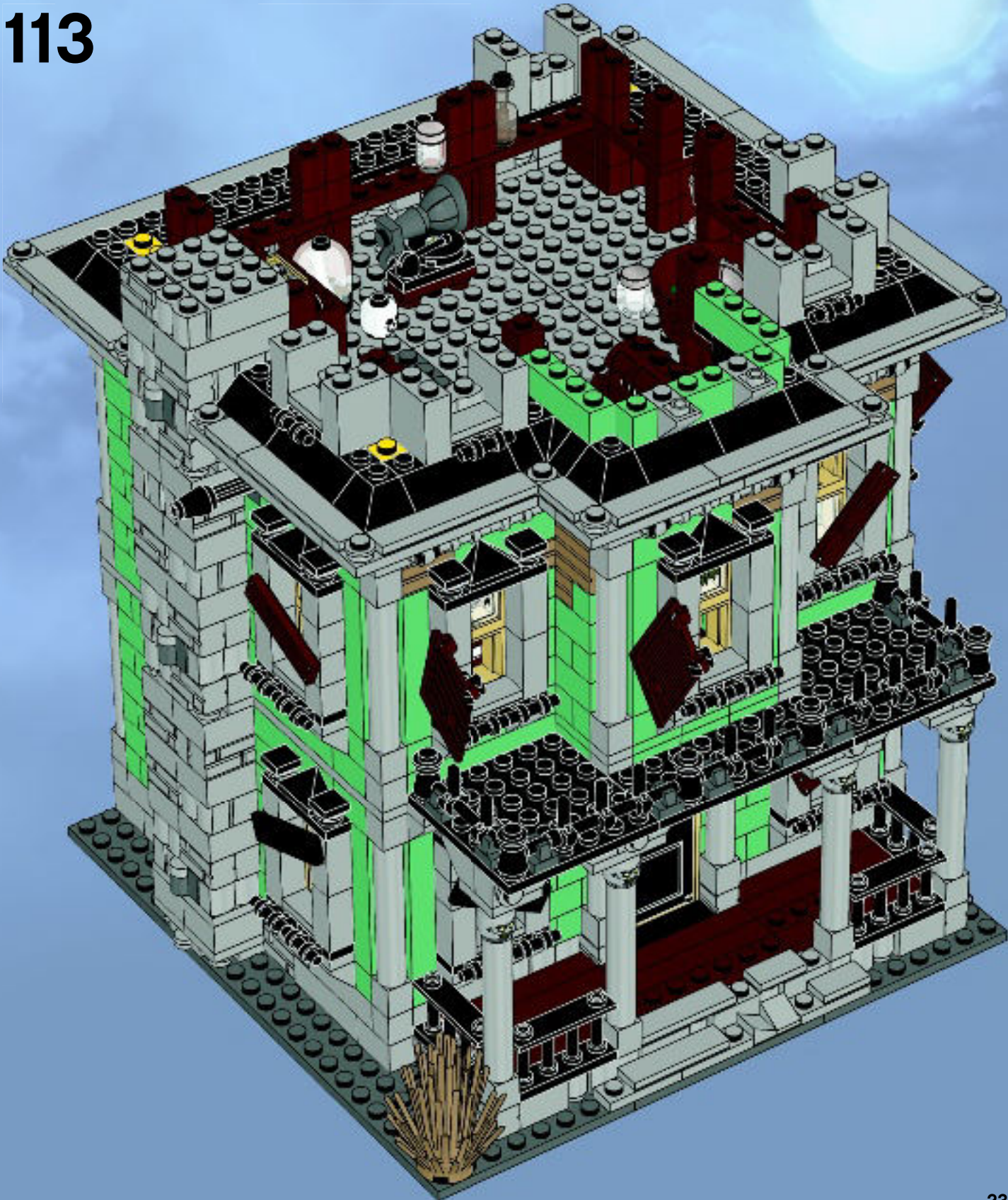



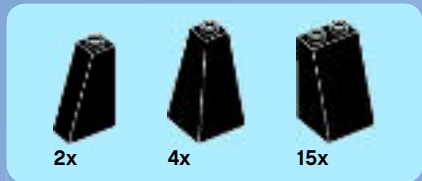

114

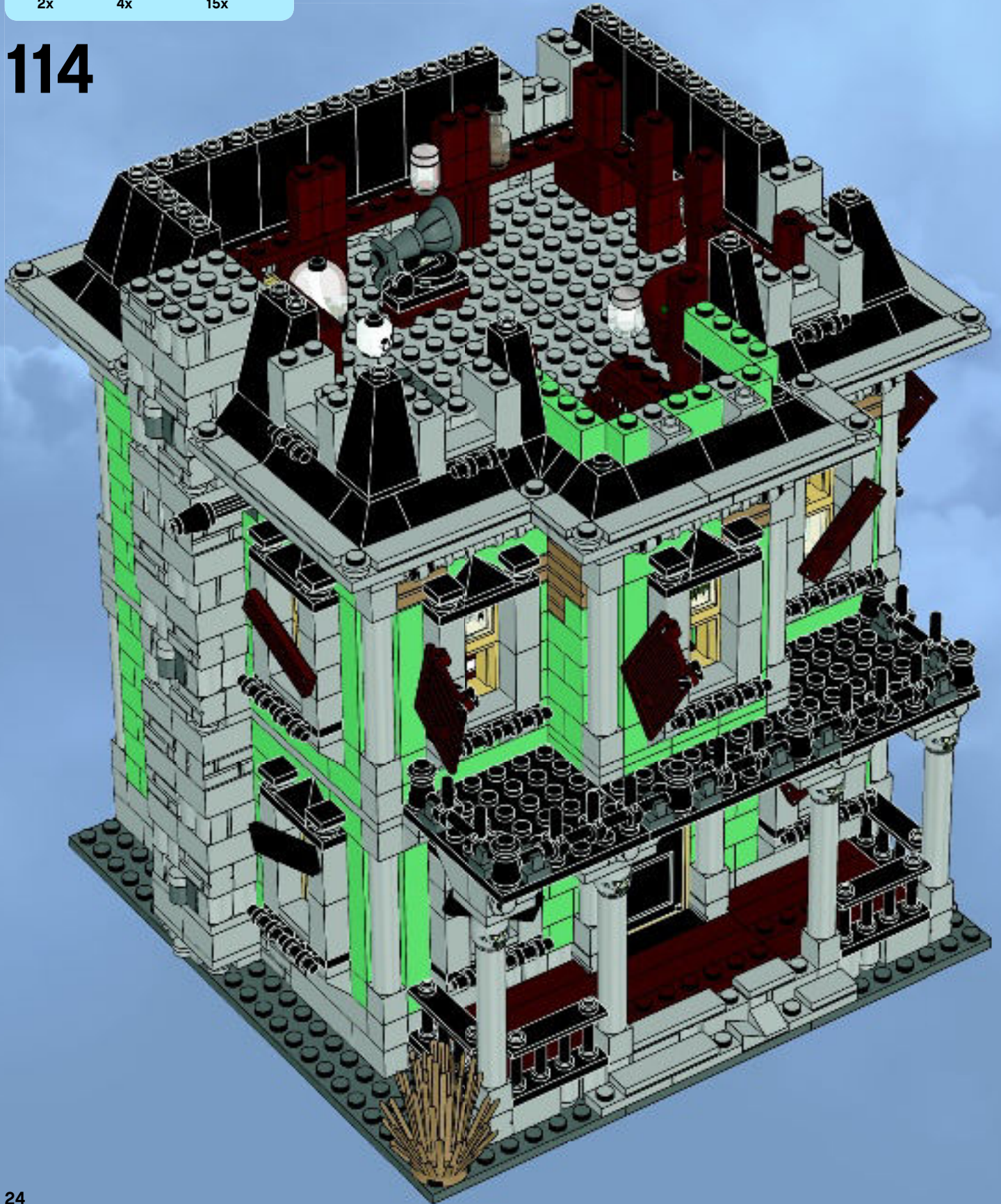





6x



6x

# 115

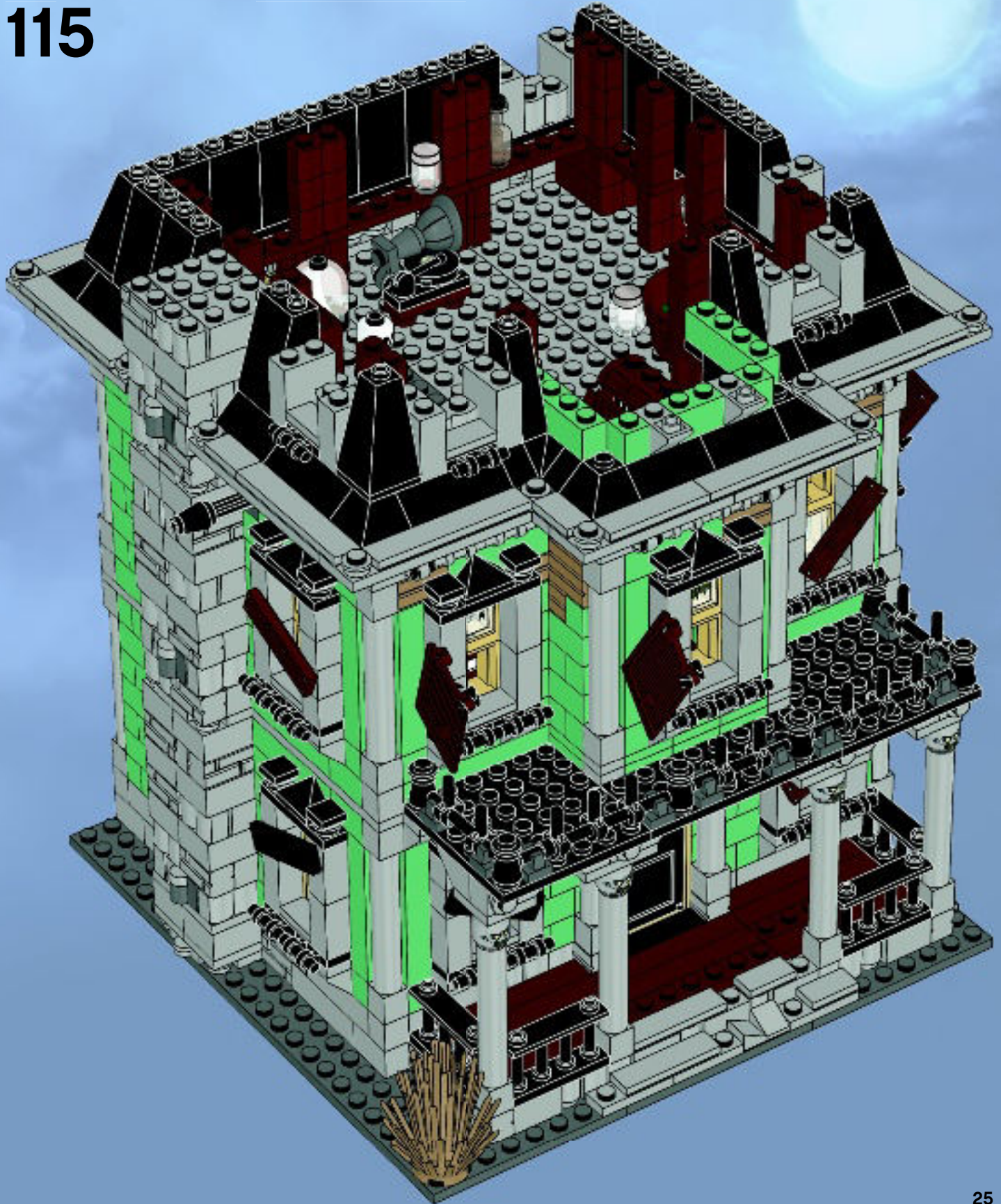



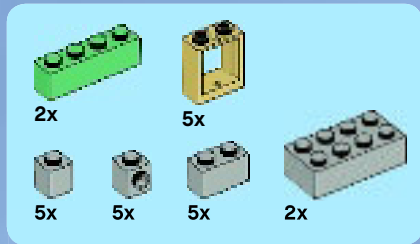

# 116

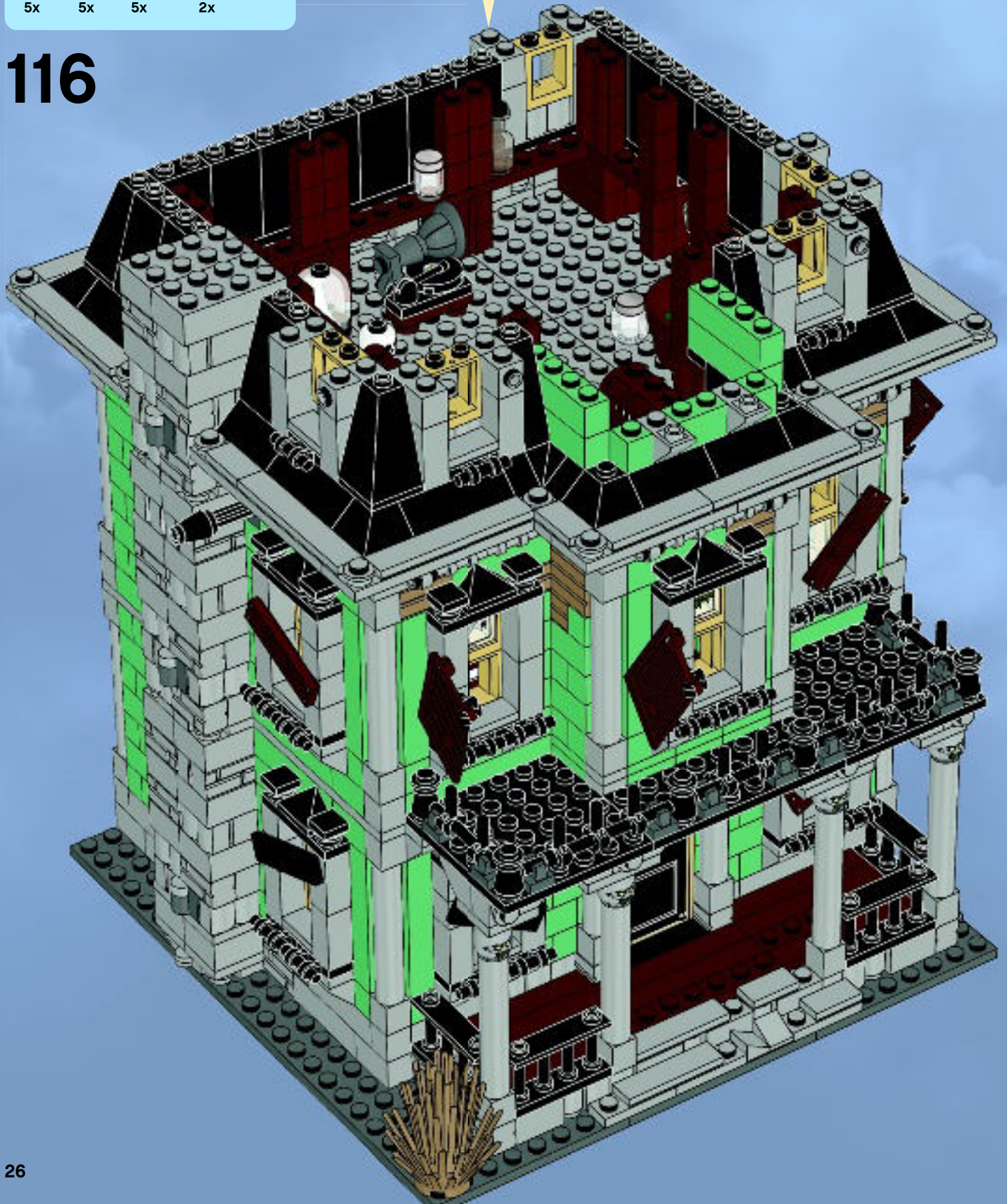



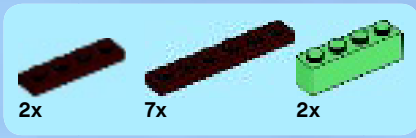



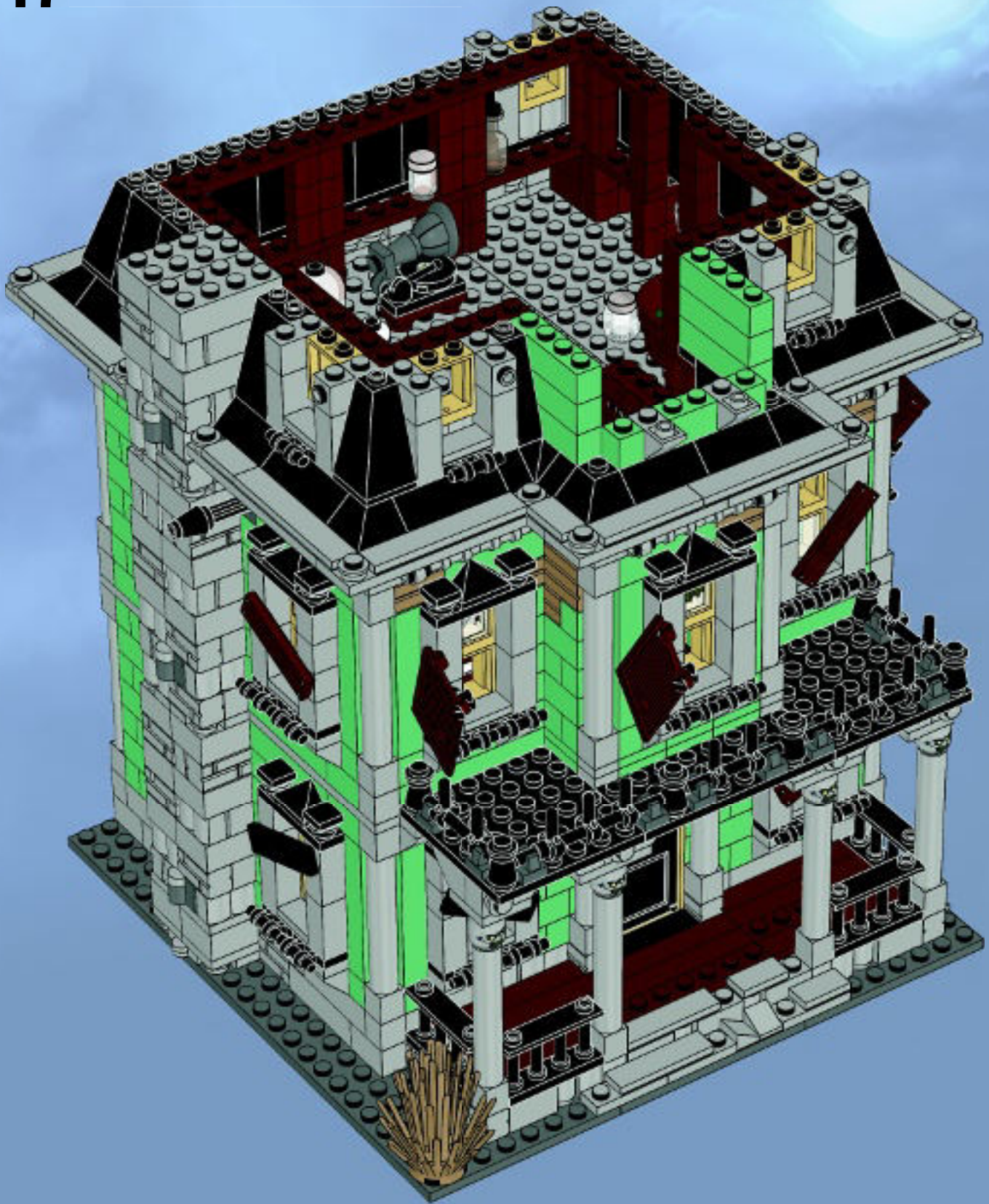

# 117





-  5x
-  10x
-  5x
-  10x

- 1** 
- 2** 
- 3**  **5x**

# 118

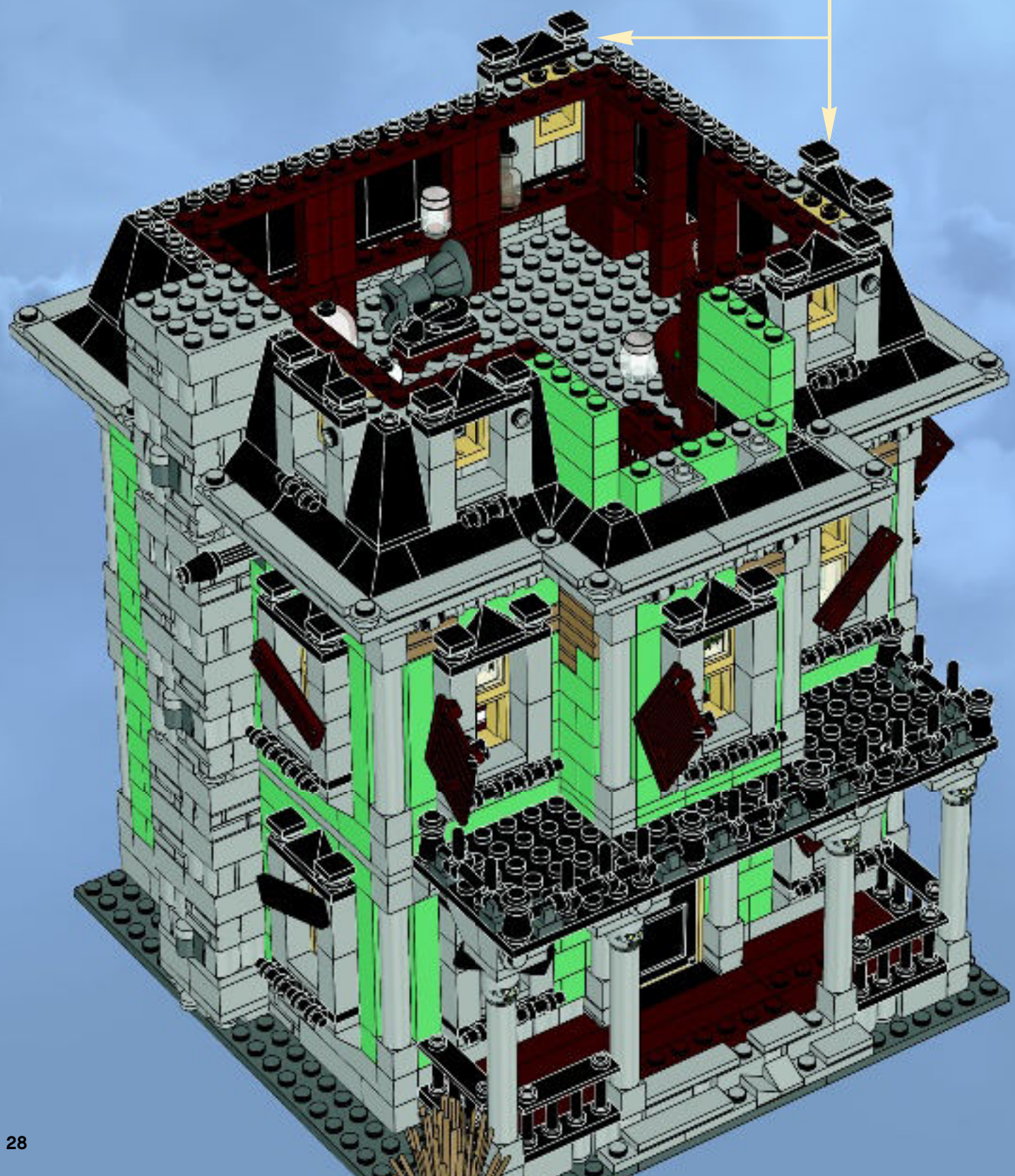



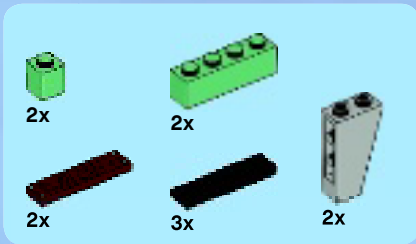

119

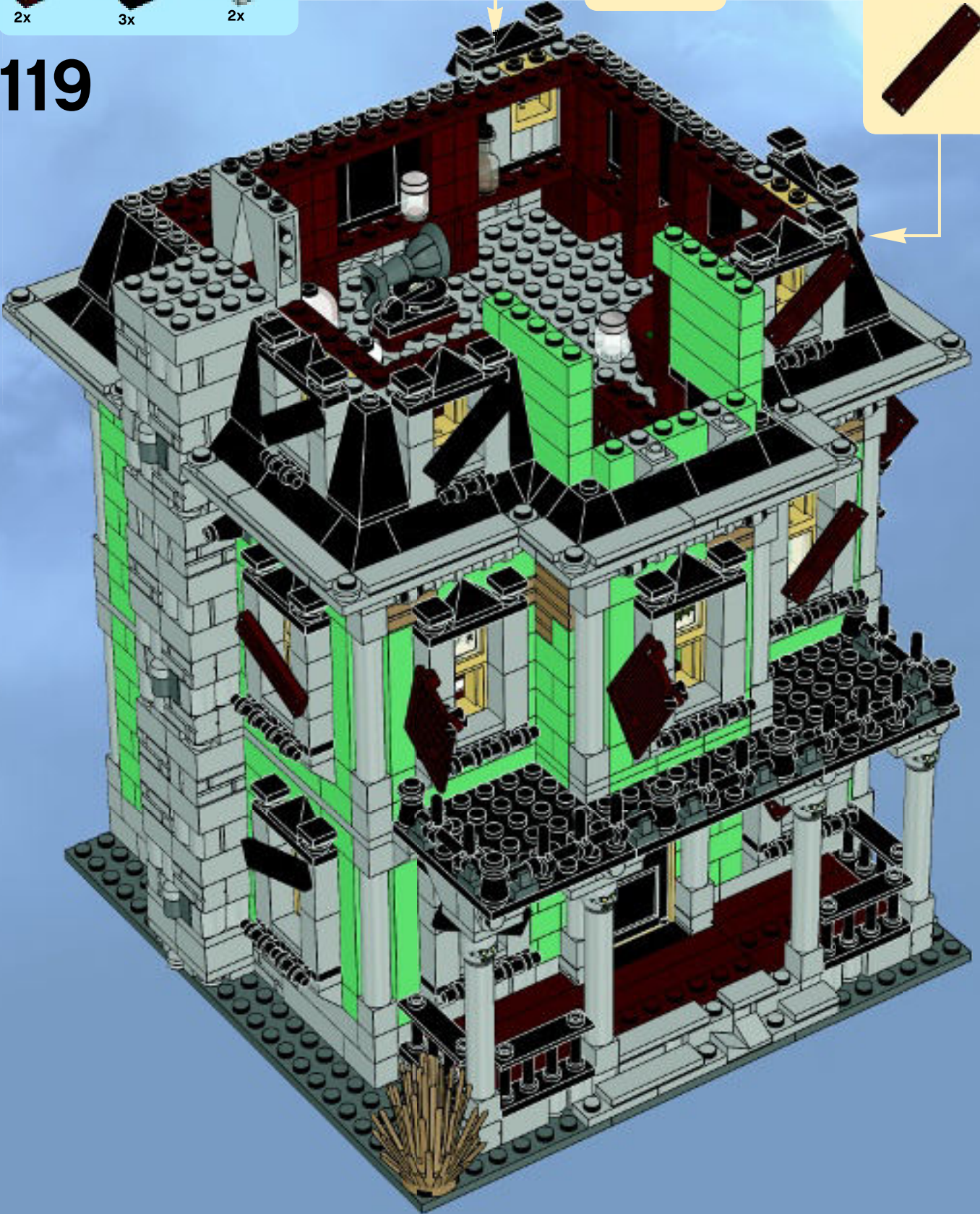





# 120

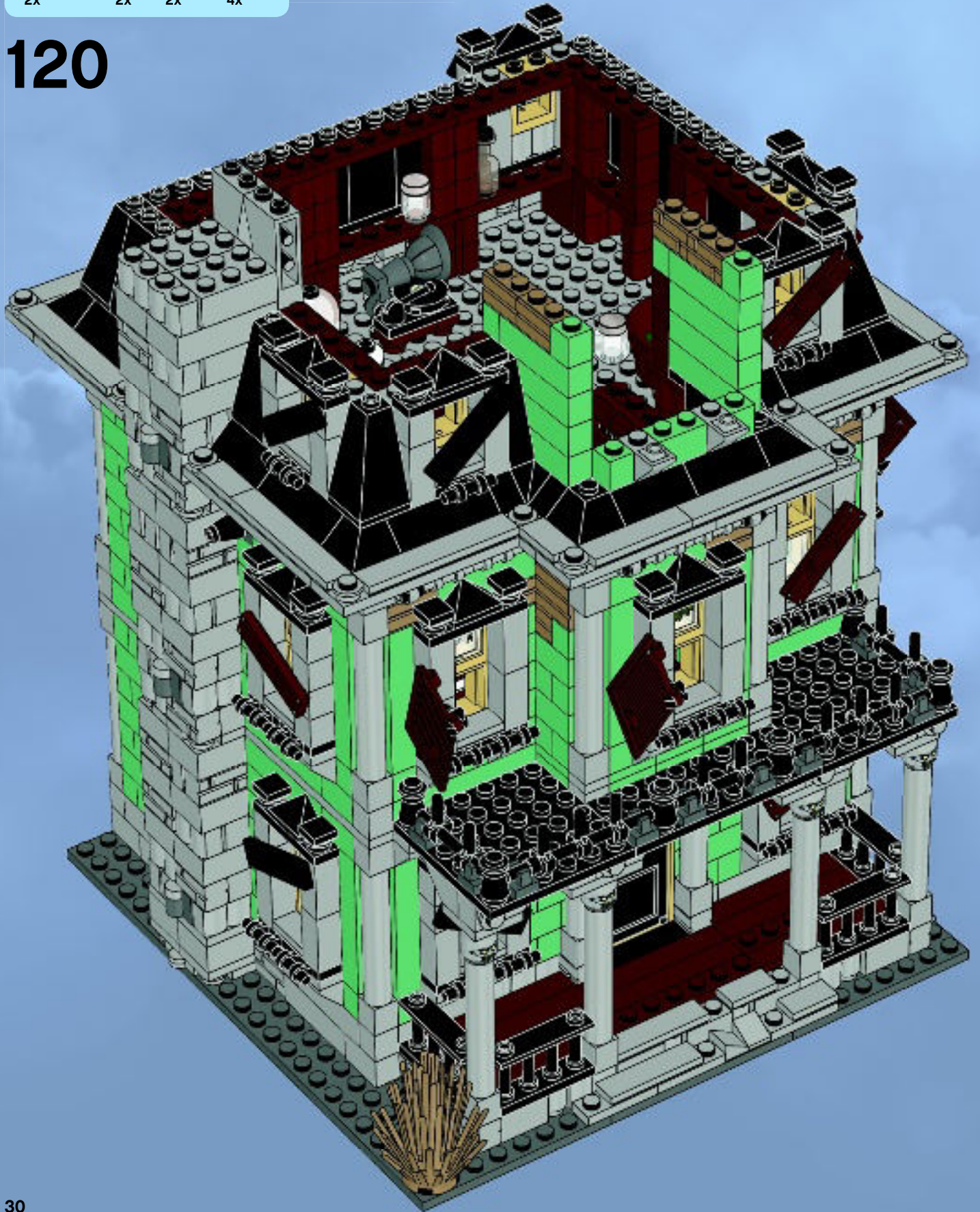





2x



2x



15x



# 121





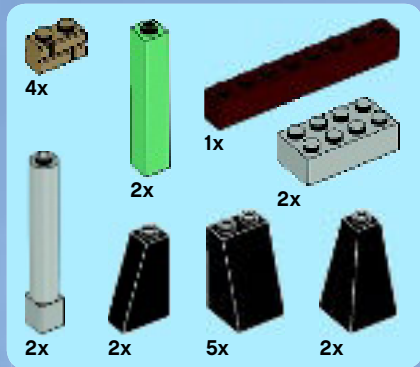

122

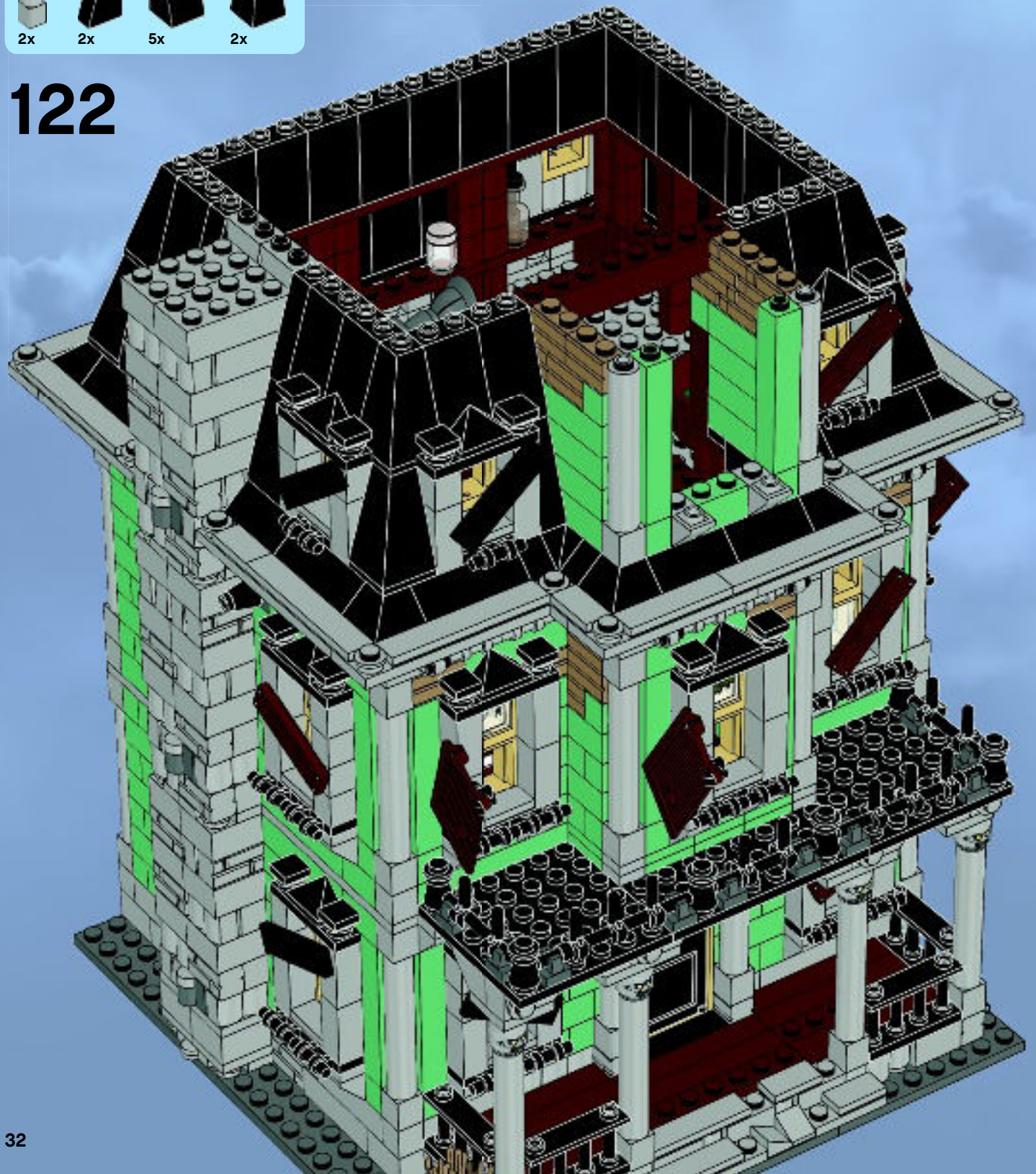



1x

1

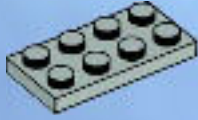

1x



2x

2



1x



1x



1x



1x

3

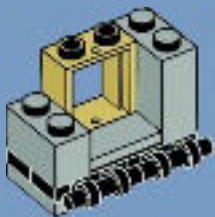

2x

4

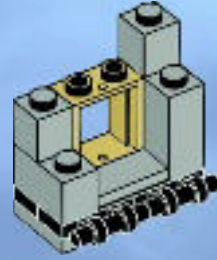

2x

5

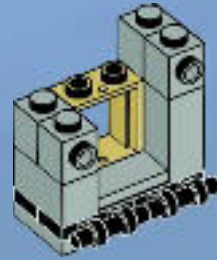

1x



1x



1x

6

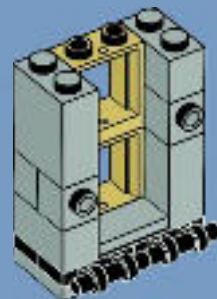



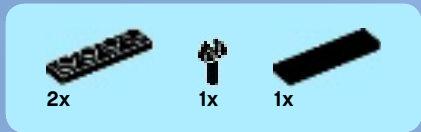

7



8

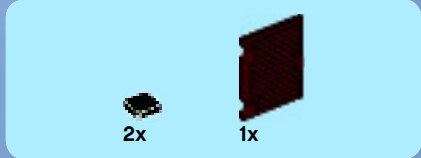

9



123

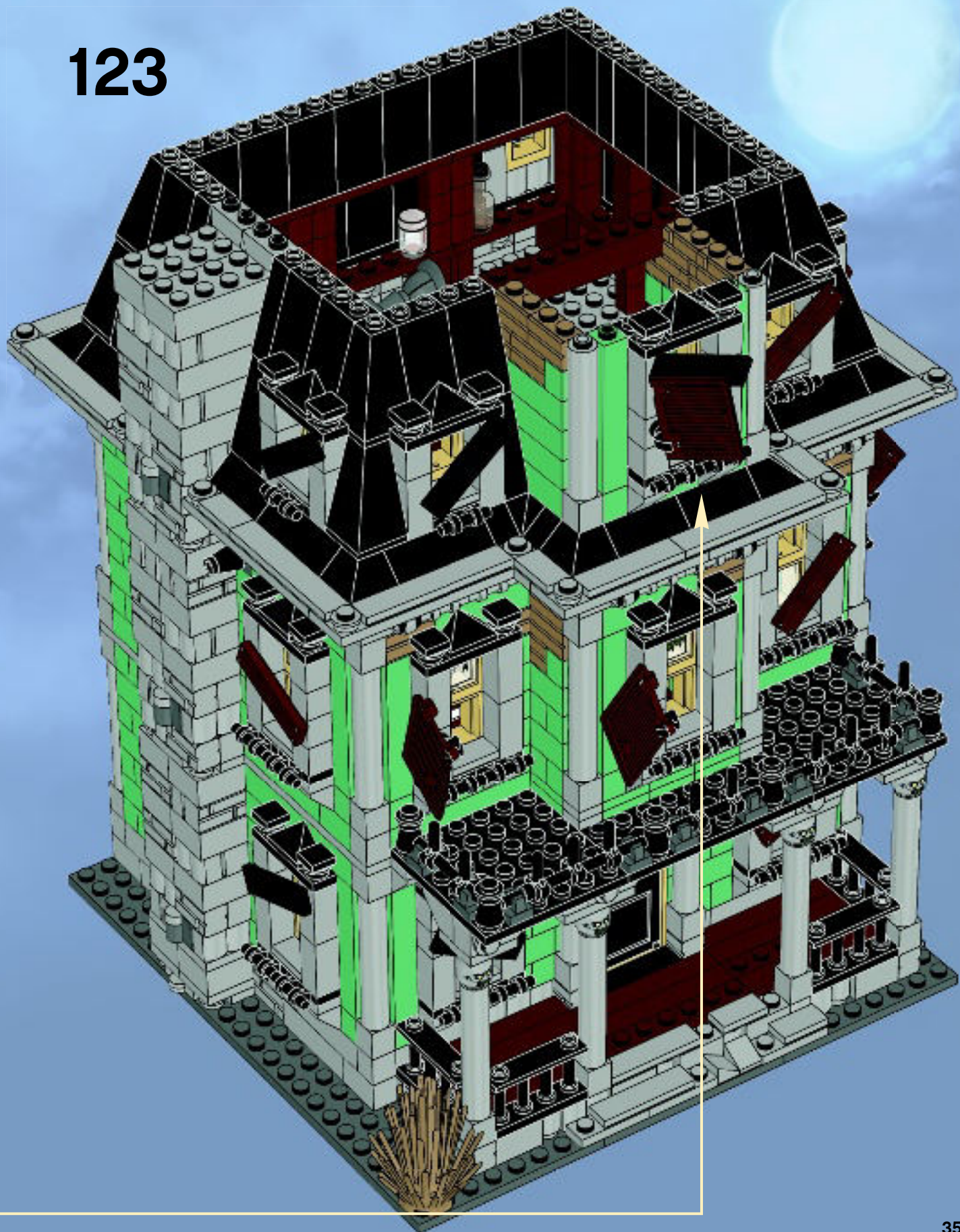



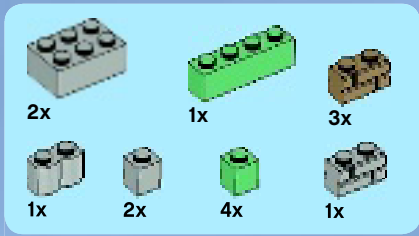

# 124

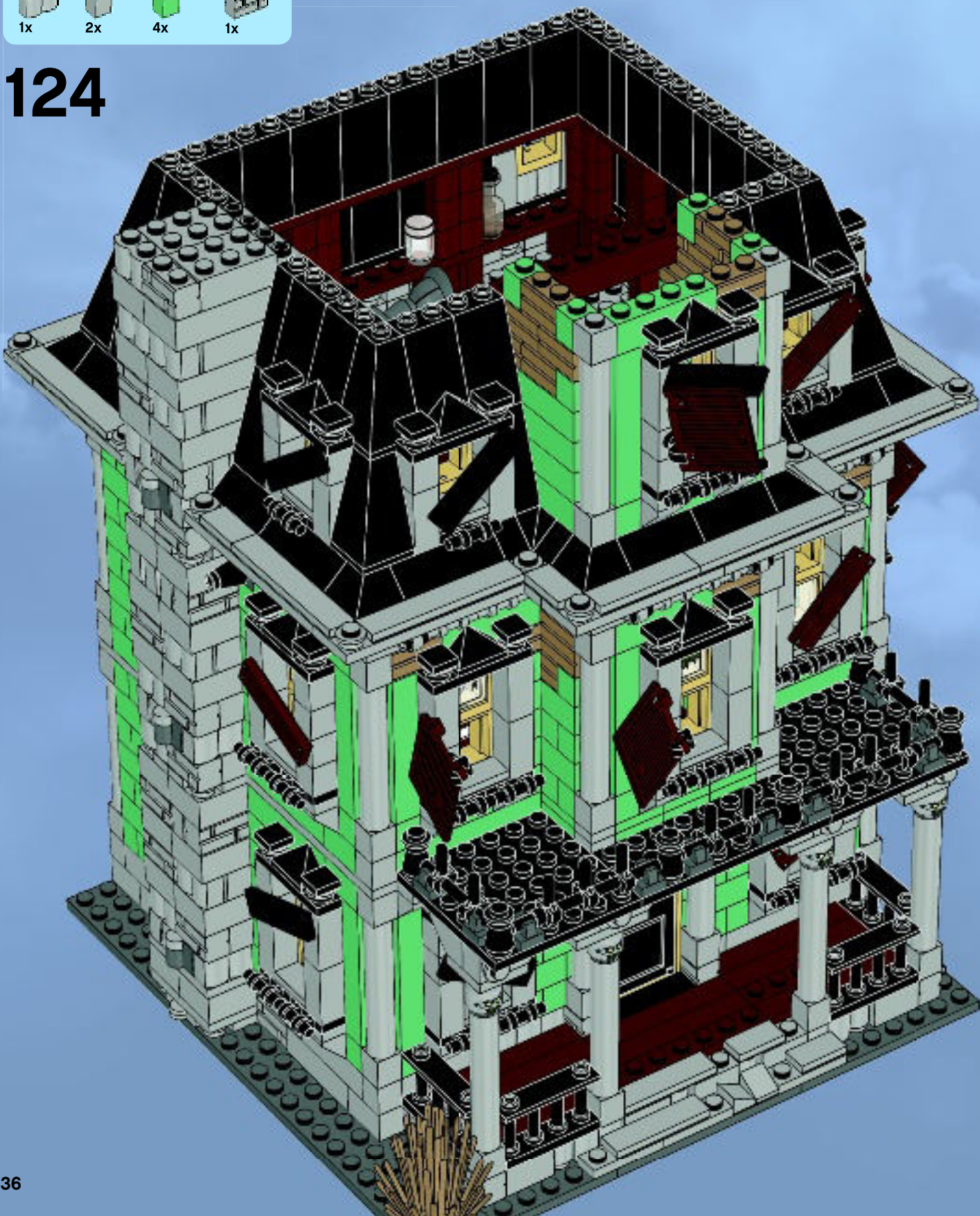

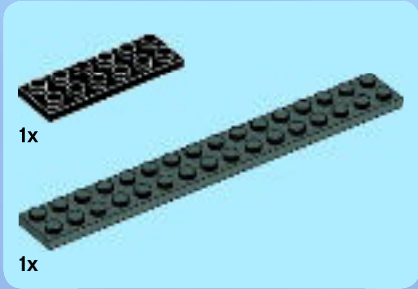

1

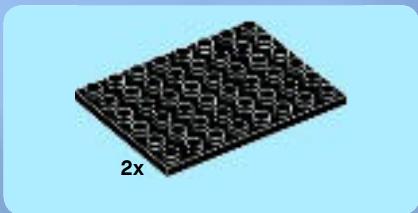
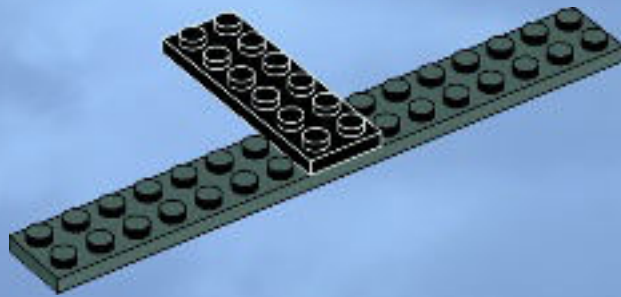

2

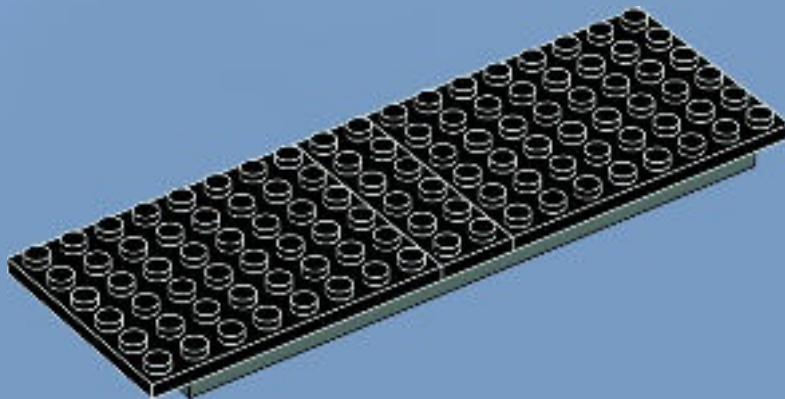



125

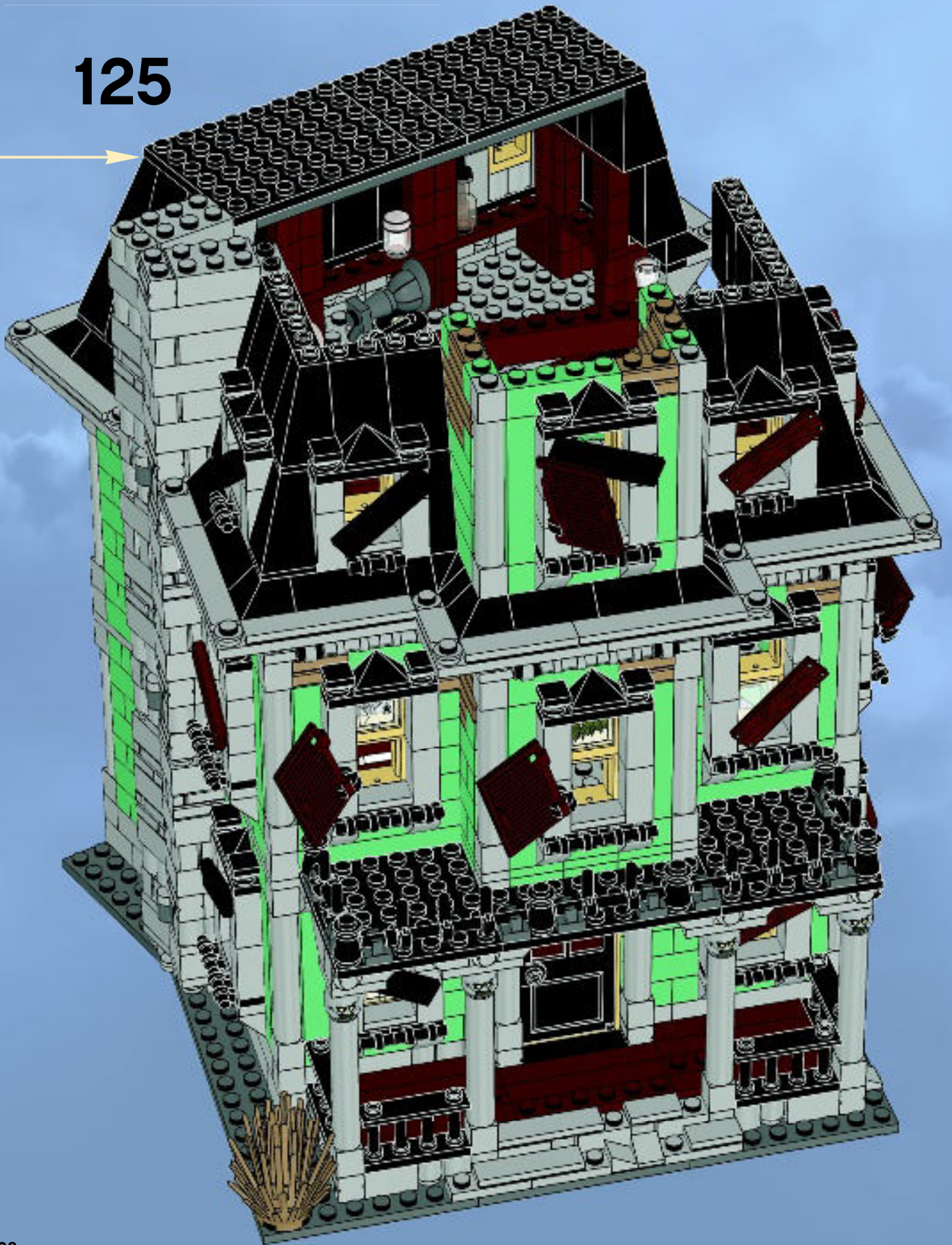



1x

1x

1

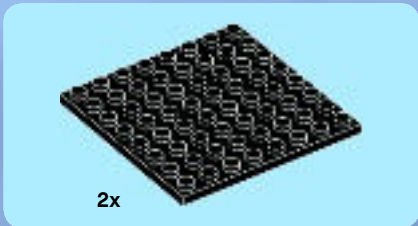
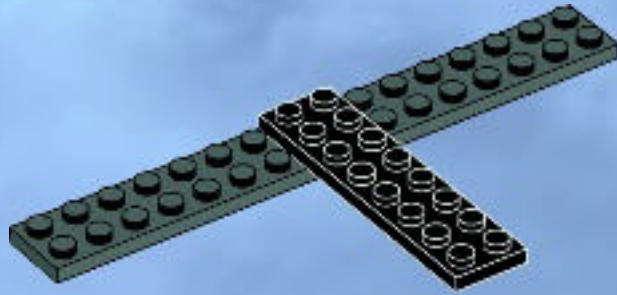

2x

2

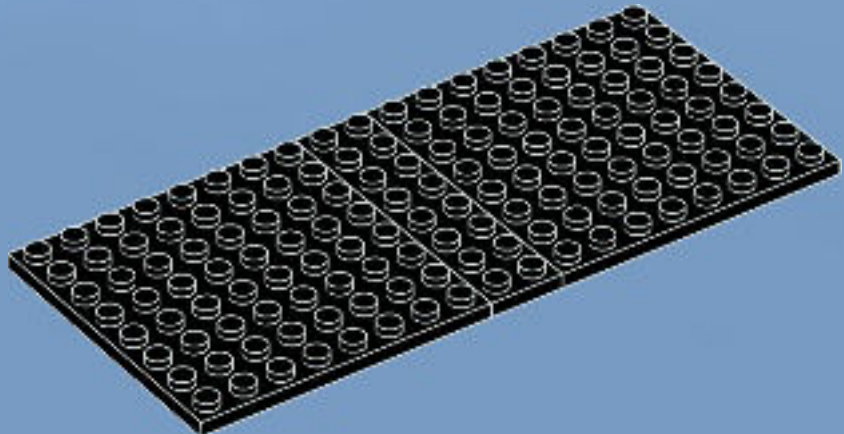



126

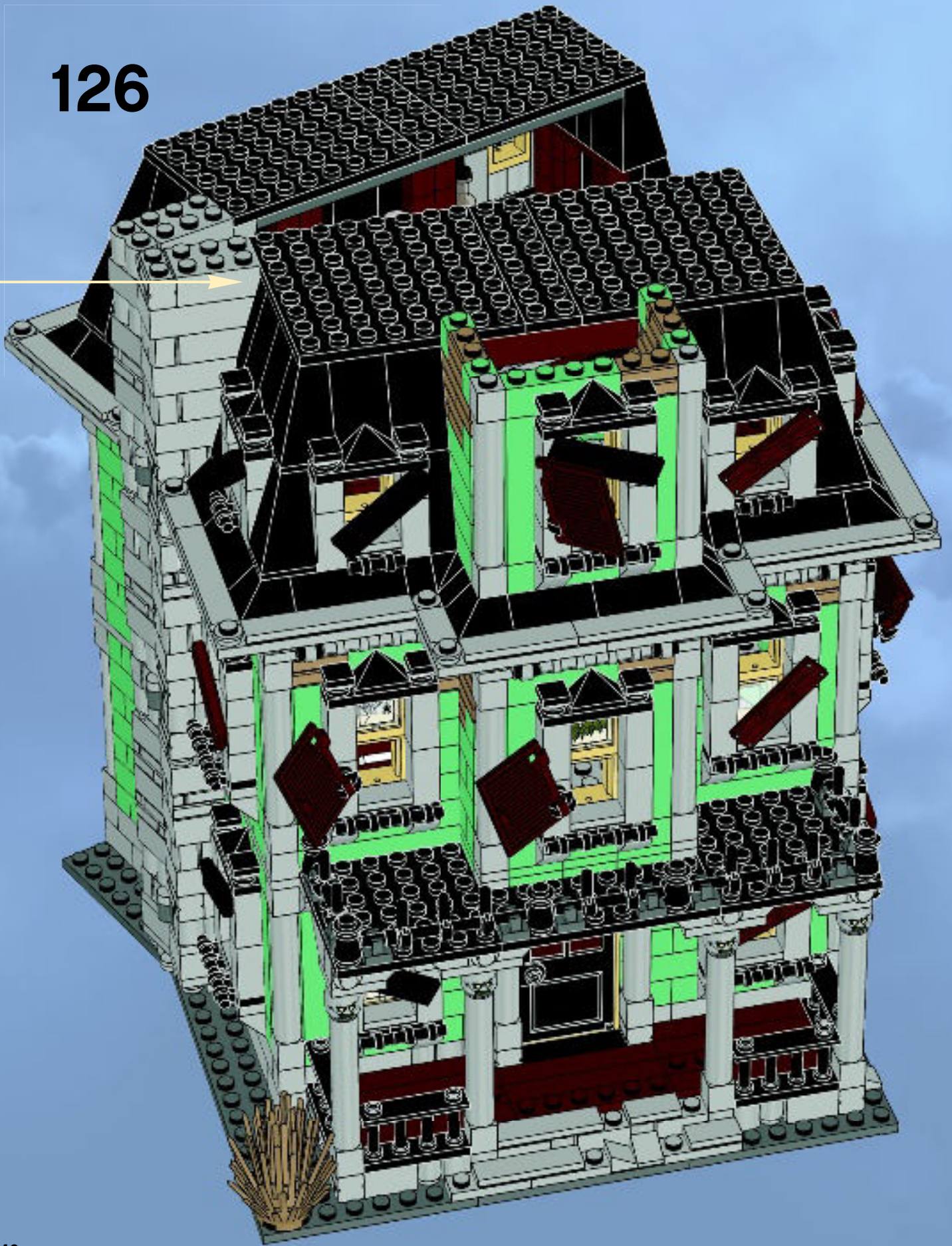





18x



6x

# 127

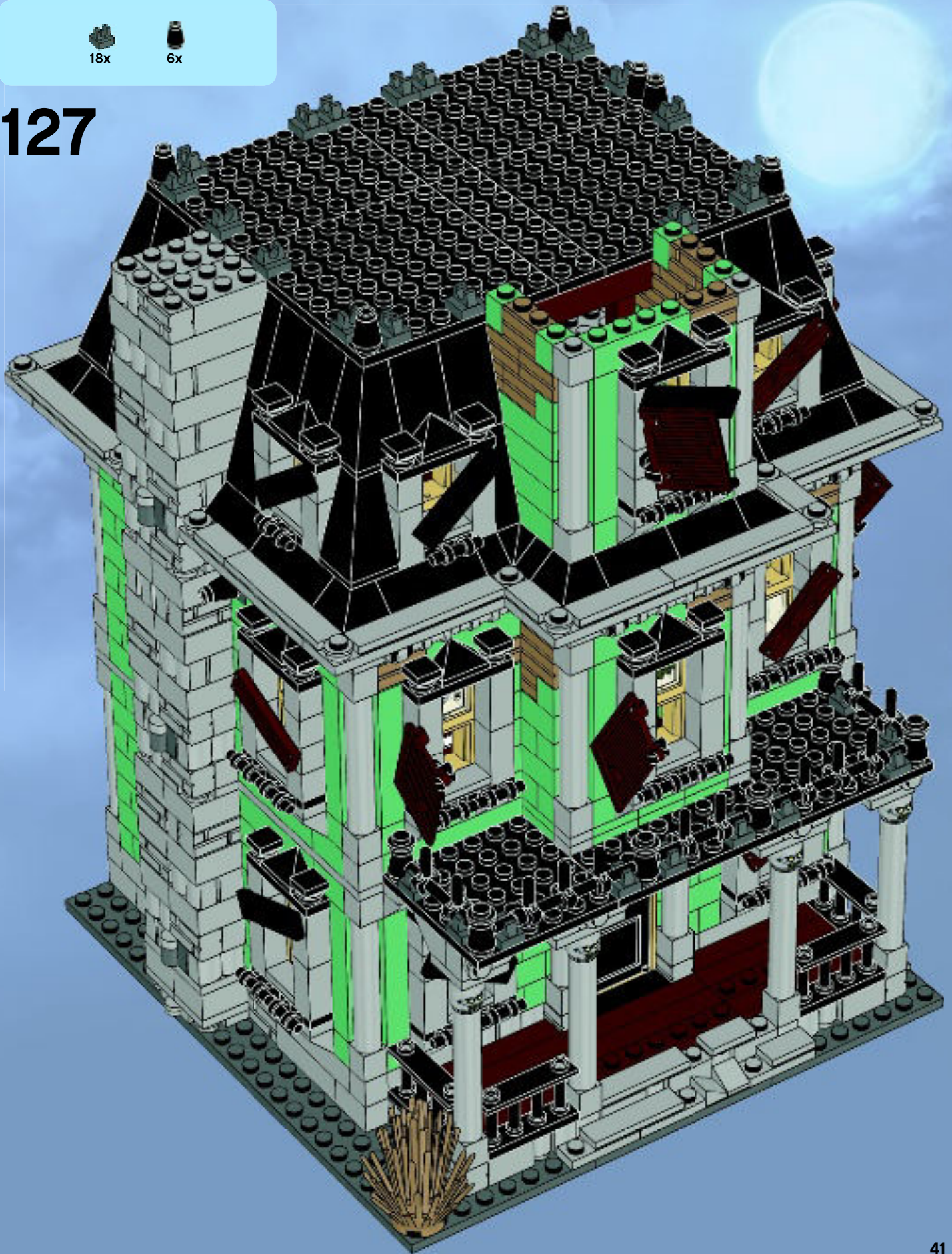



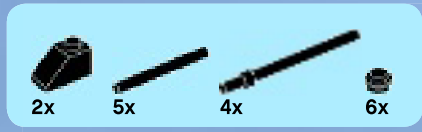

# 128

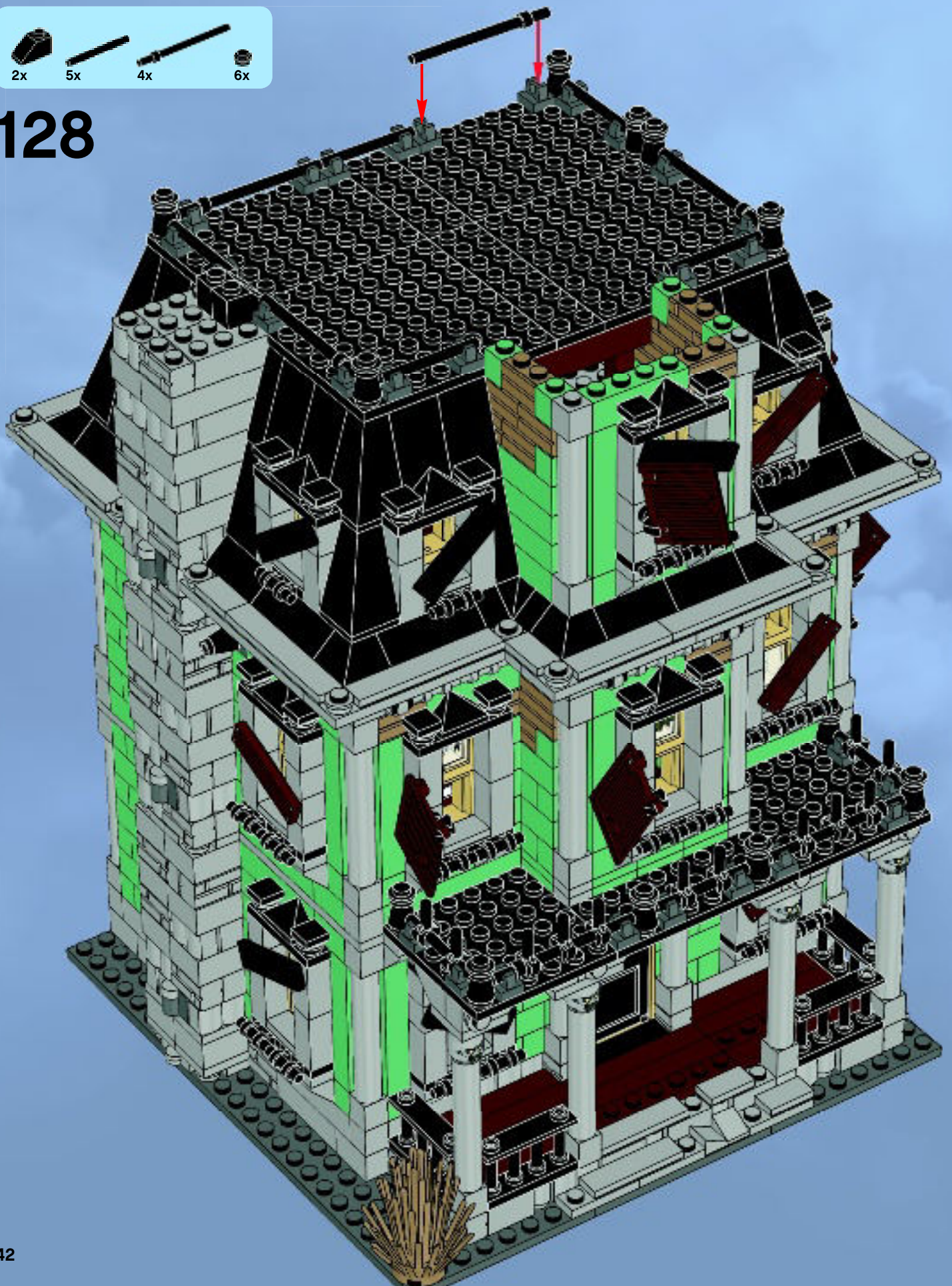





2x



2x



2x



5x

# 129

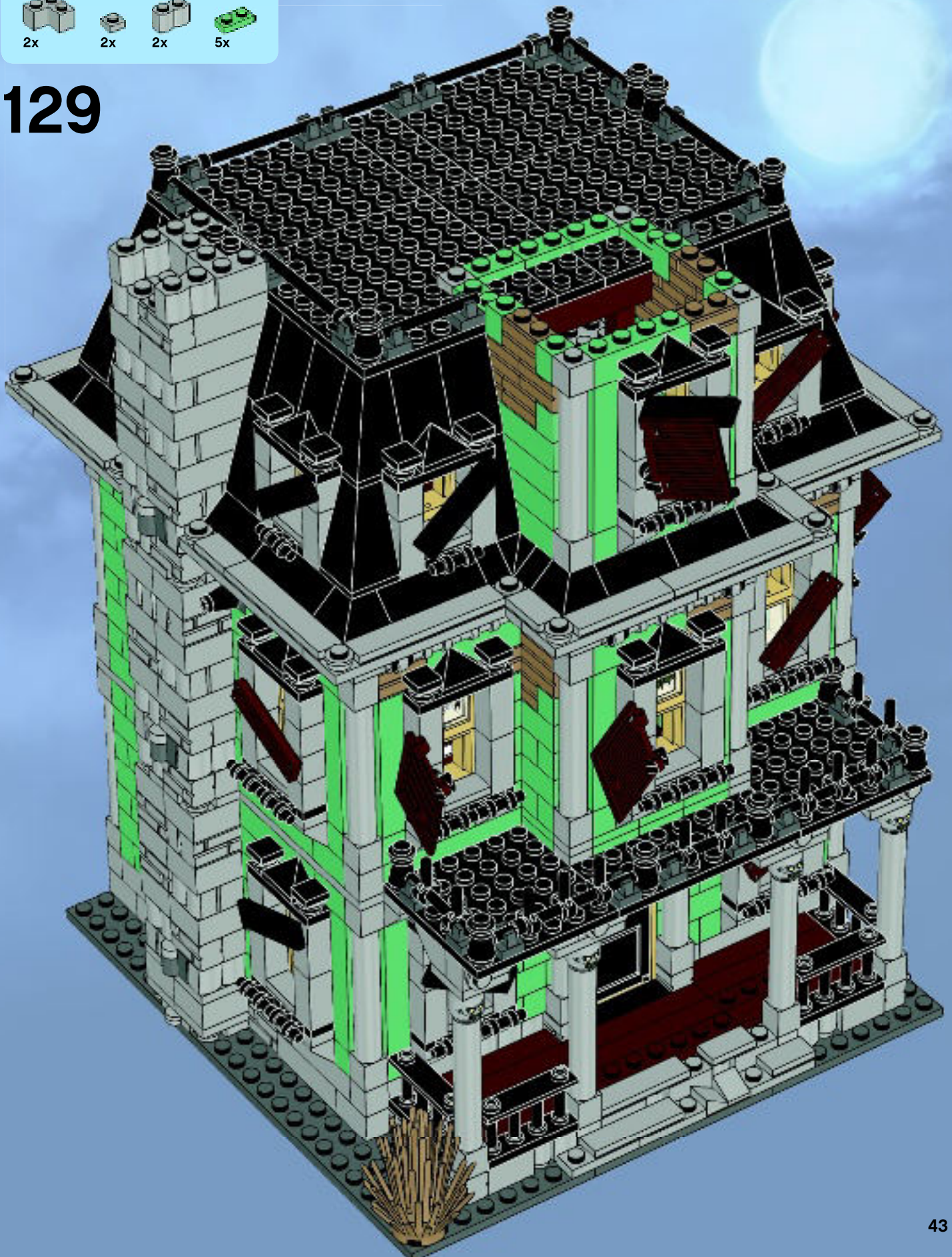





1x



22x



1x

# 130

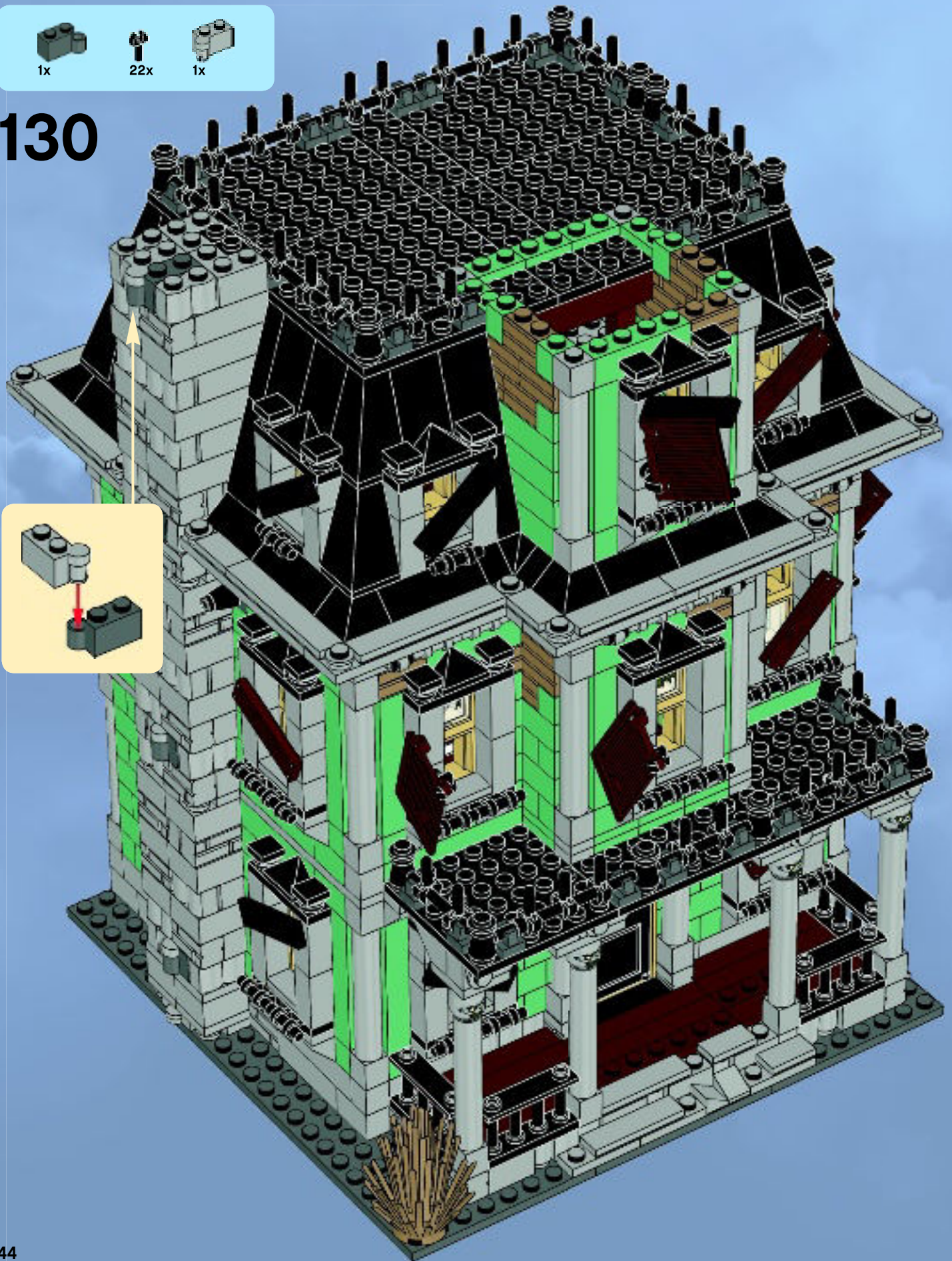





2x



2x



5x

# 131

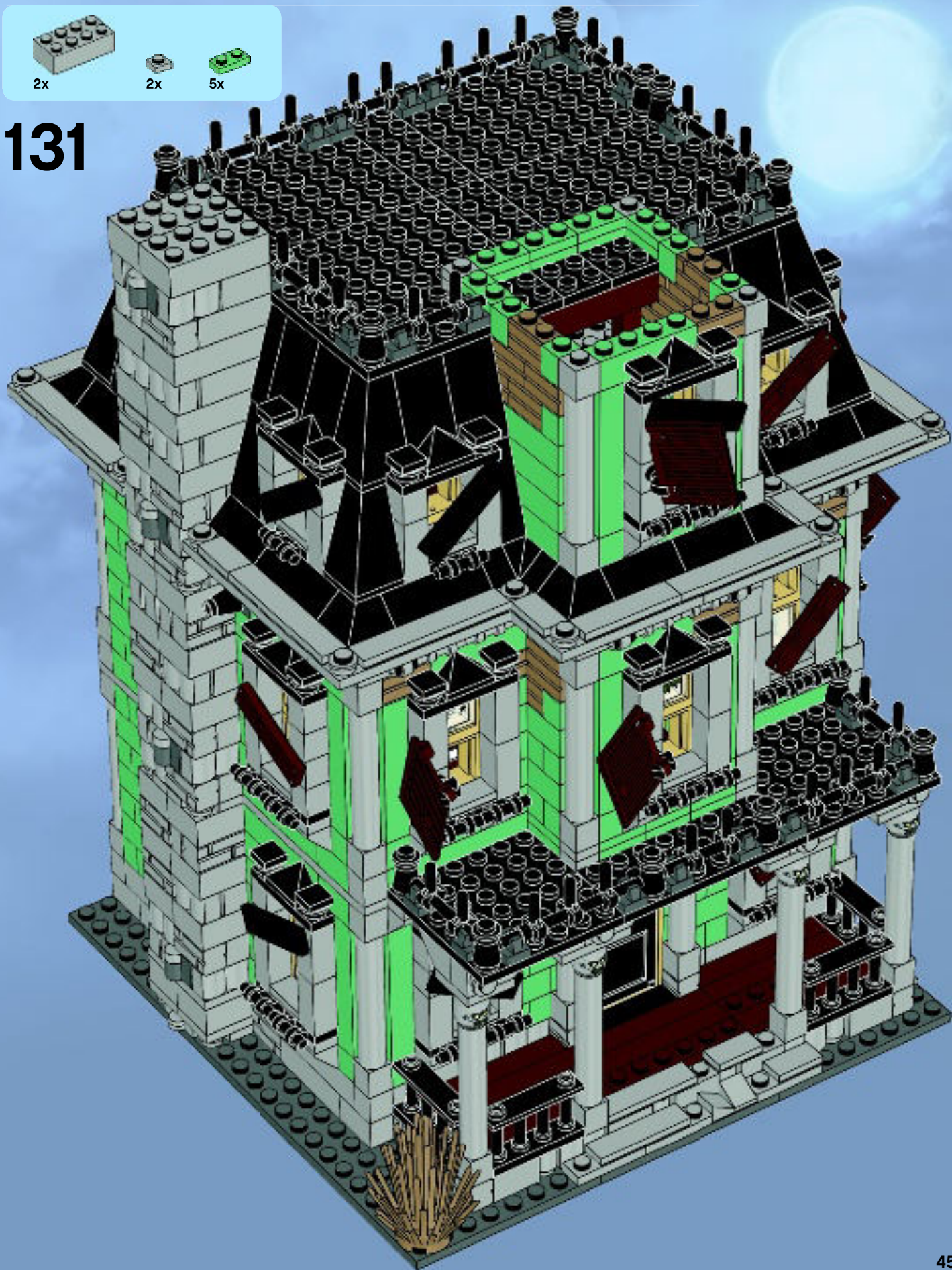





132

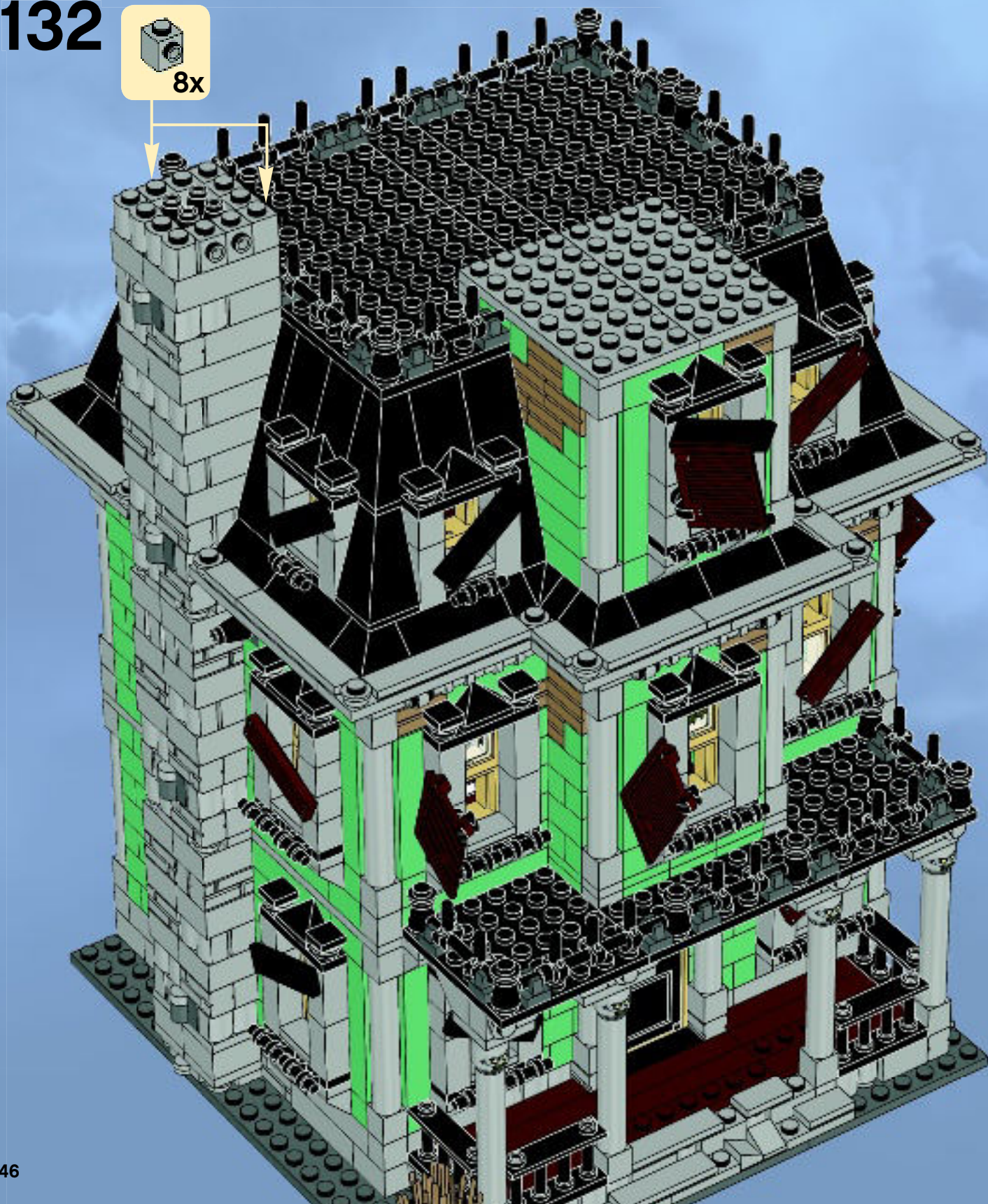



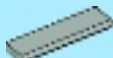

4x



2x



2x

# 133

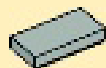

2x

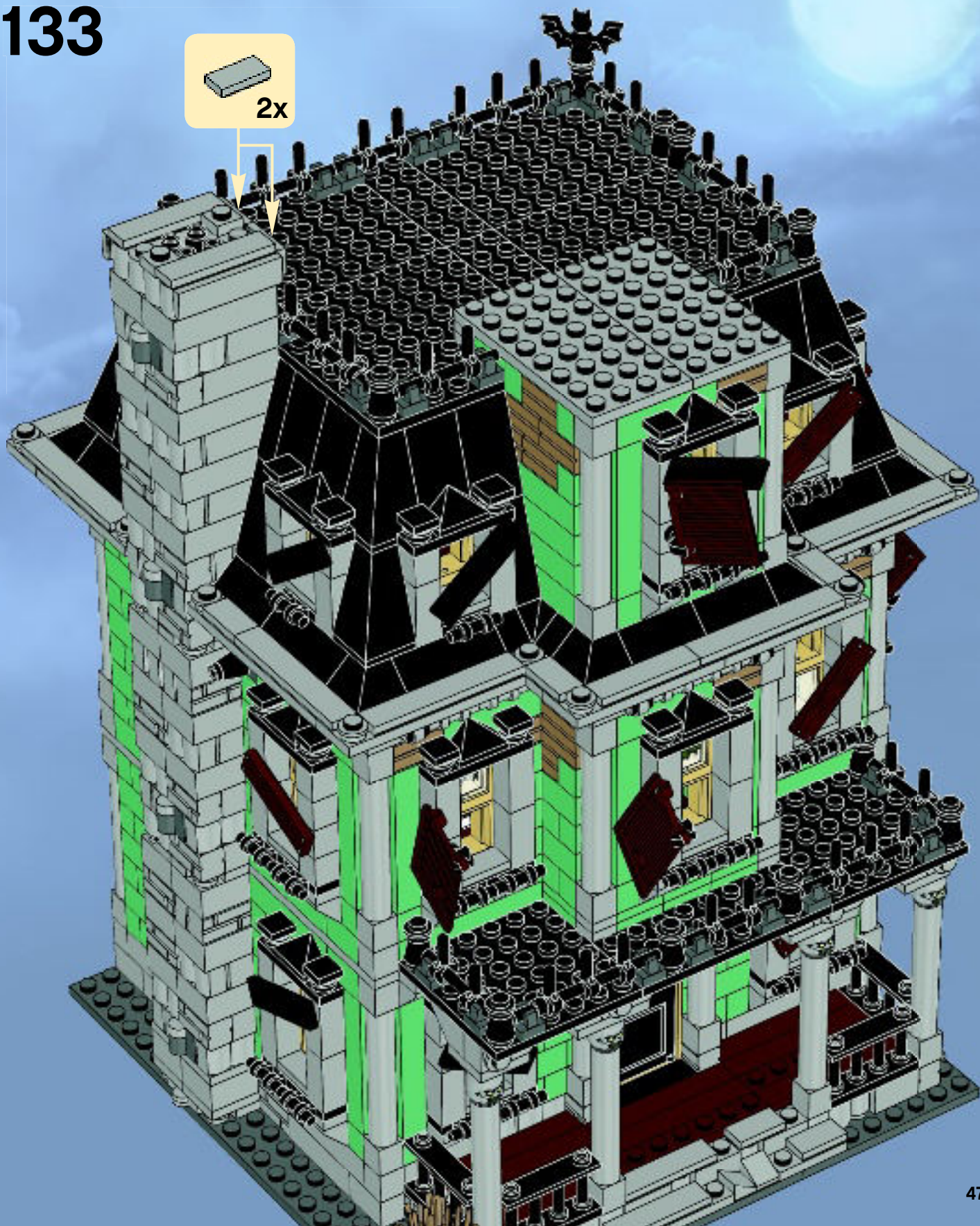





5

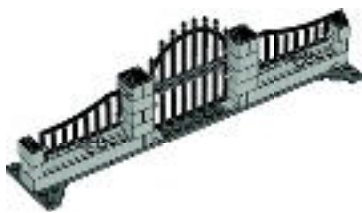

4x



8x



8x

134

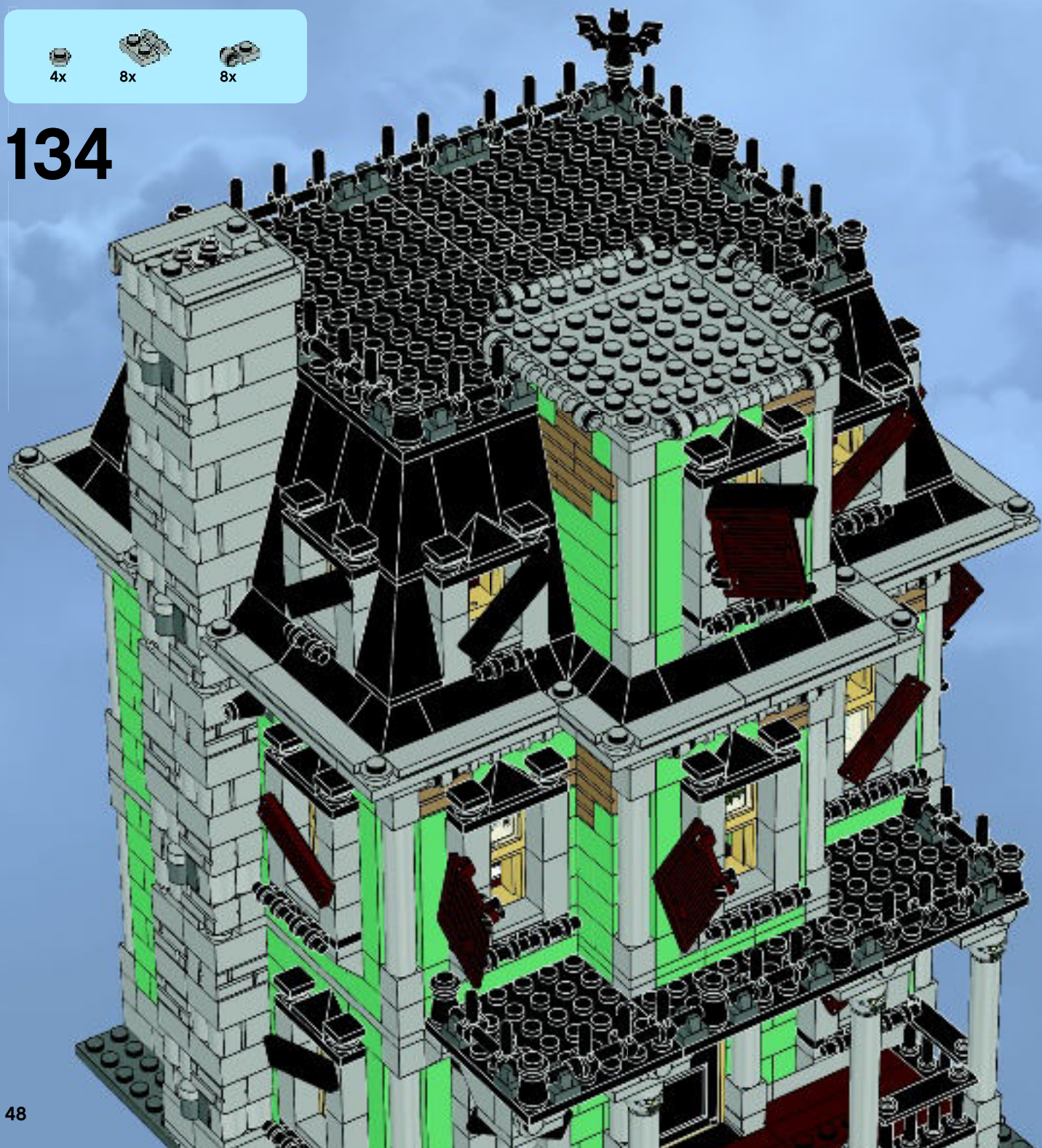





4x



8x



8x

# 135

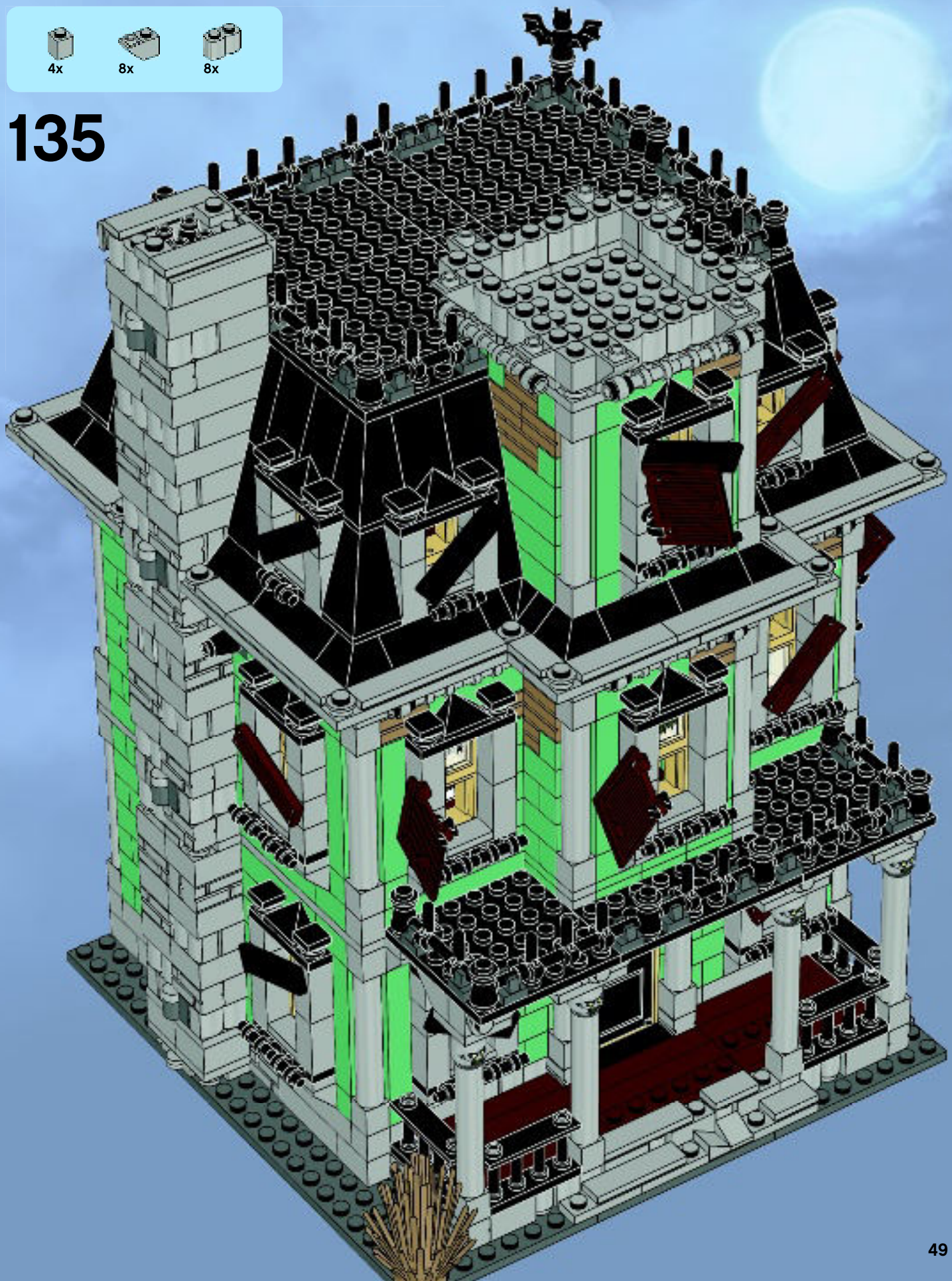



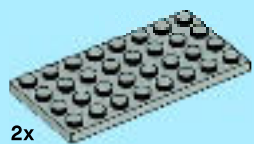

2x

# 136

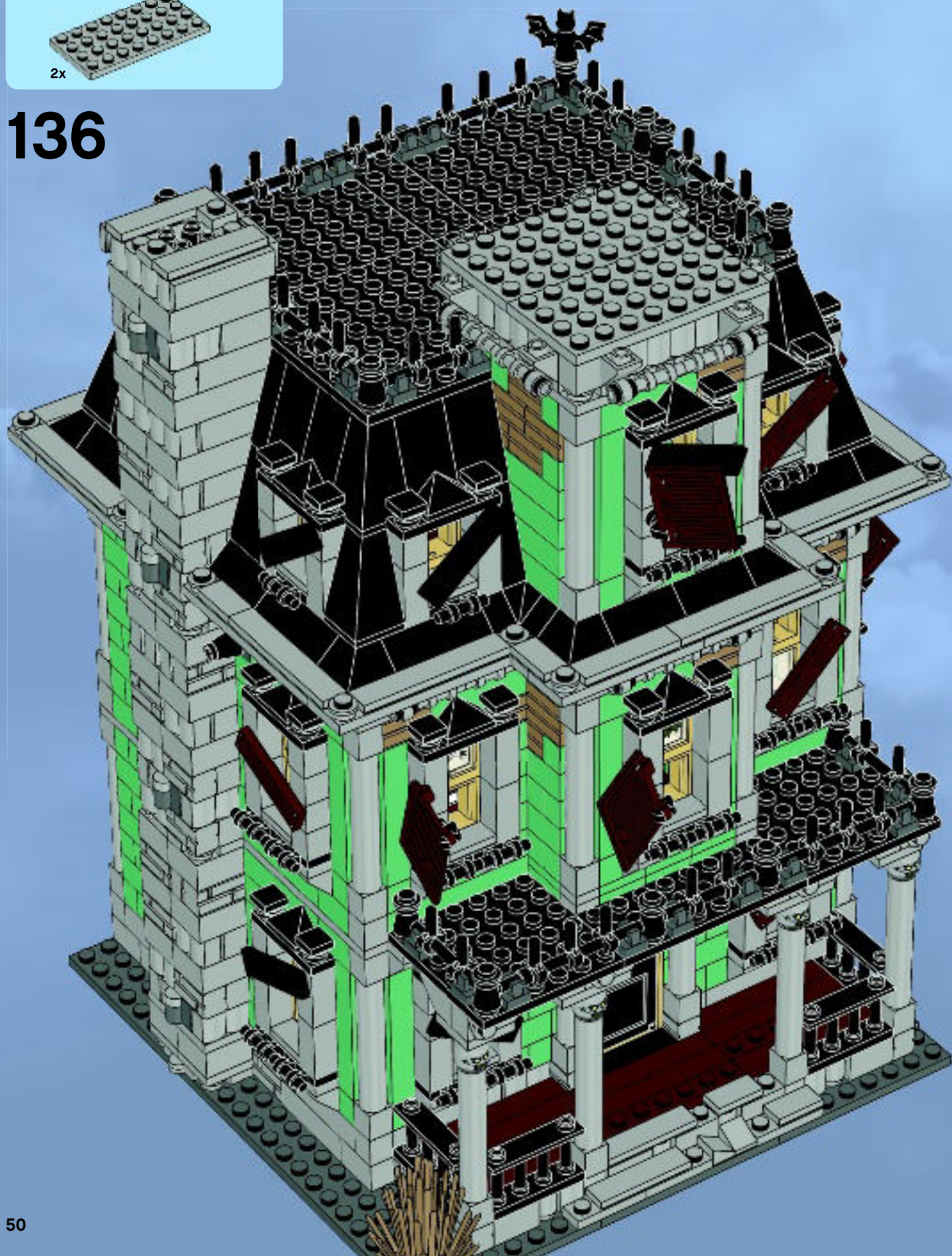



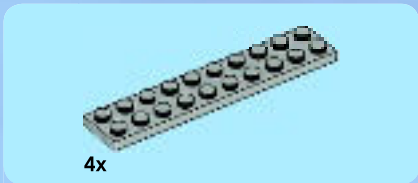

4x

# 137

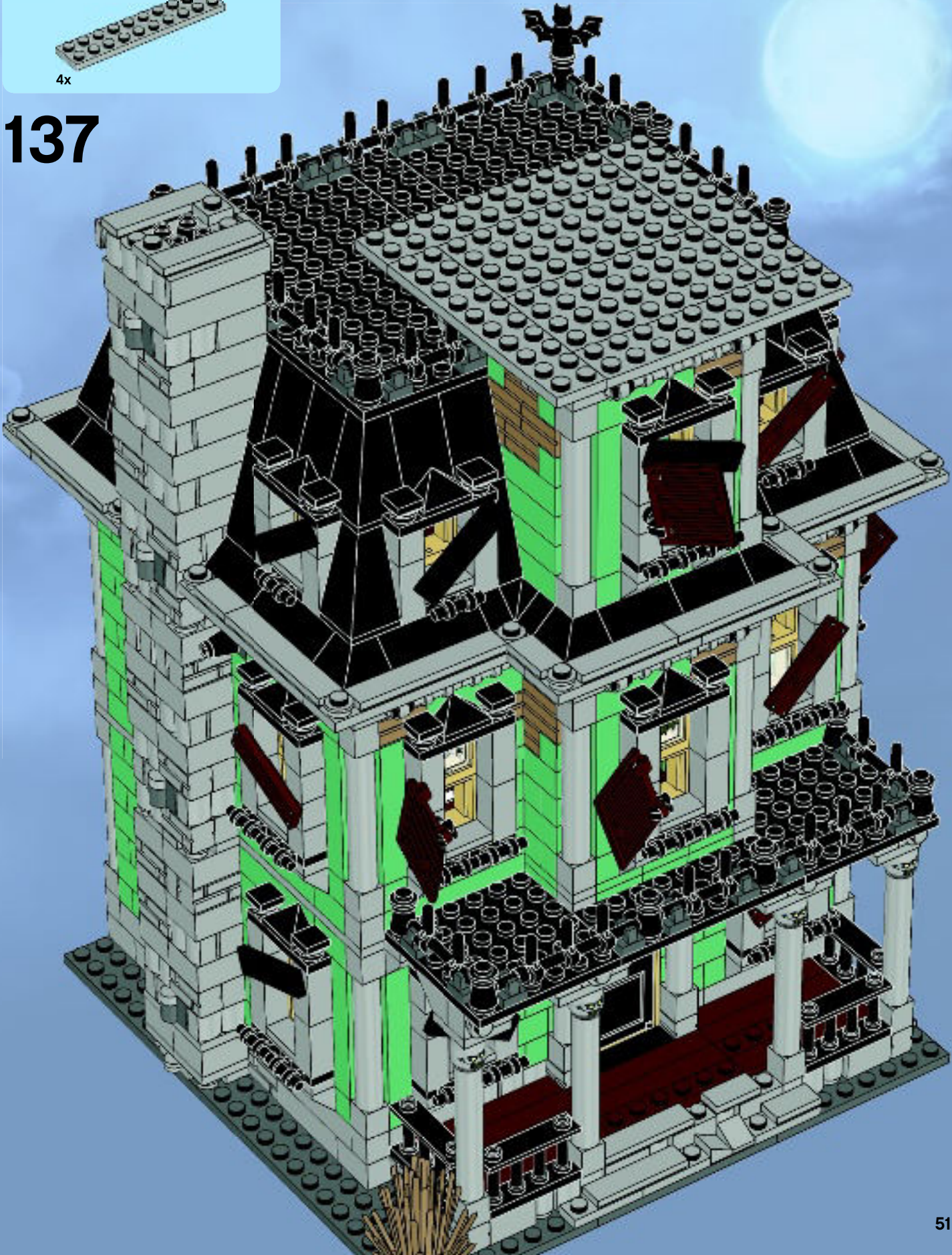





4x

# 138

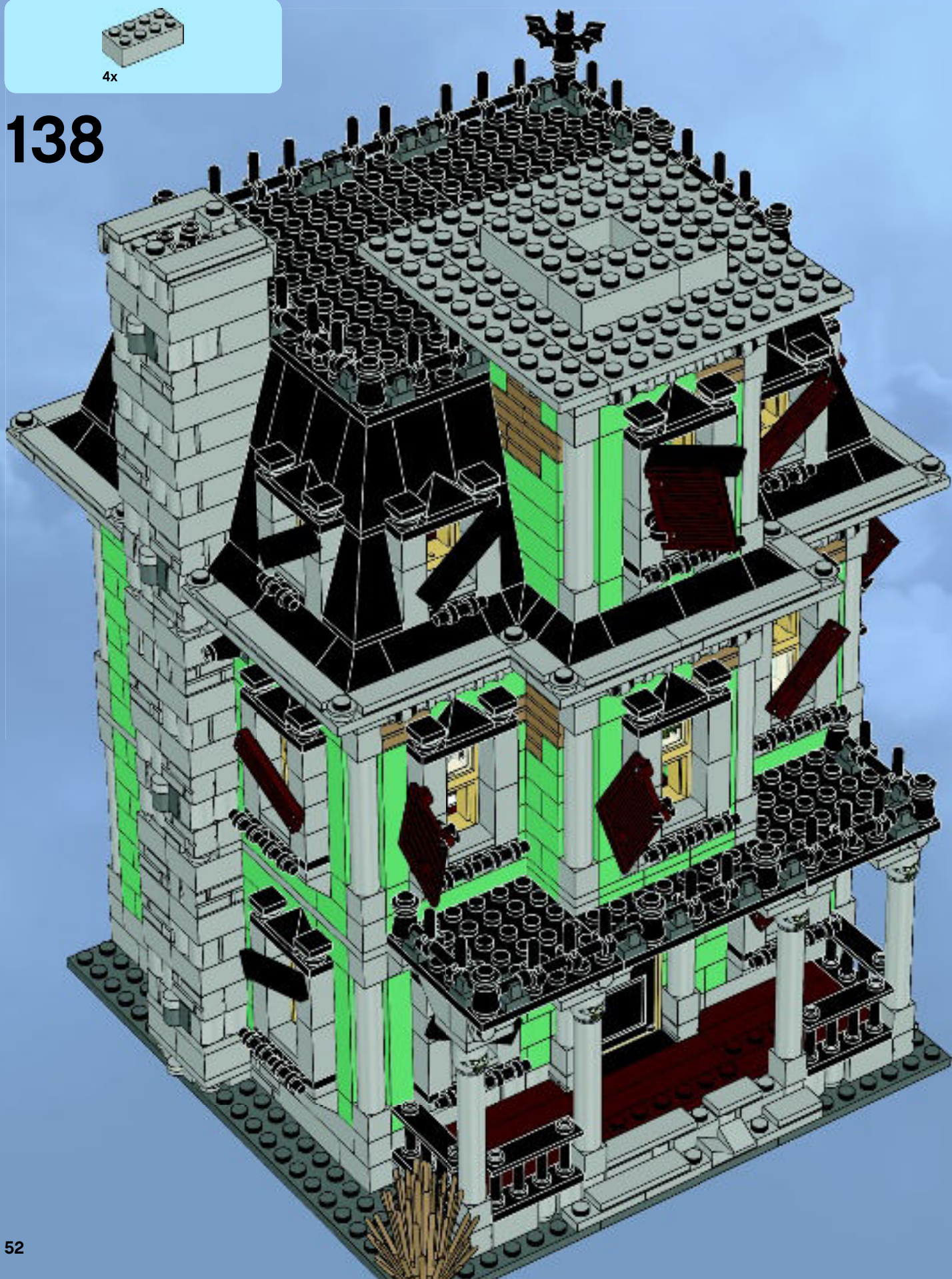





8x



4x

# 139

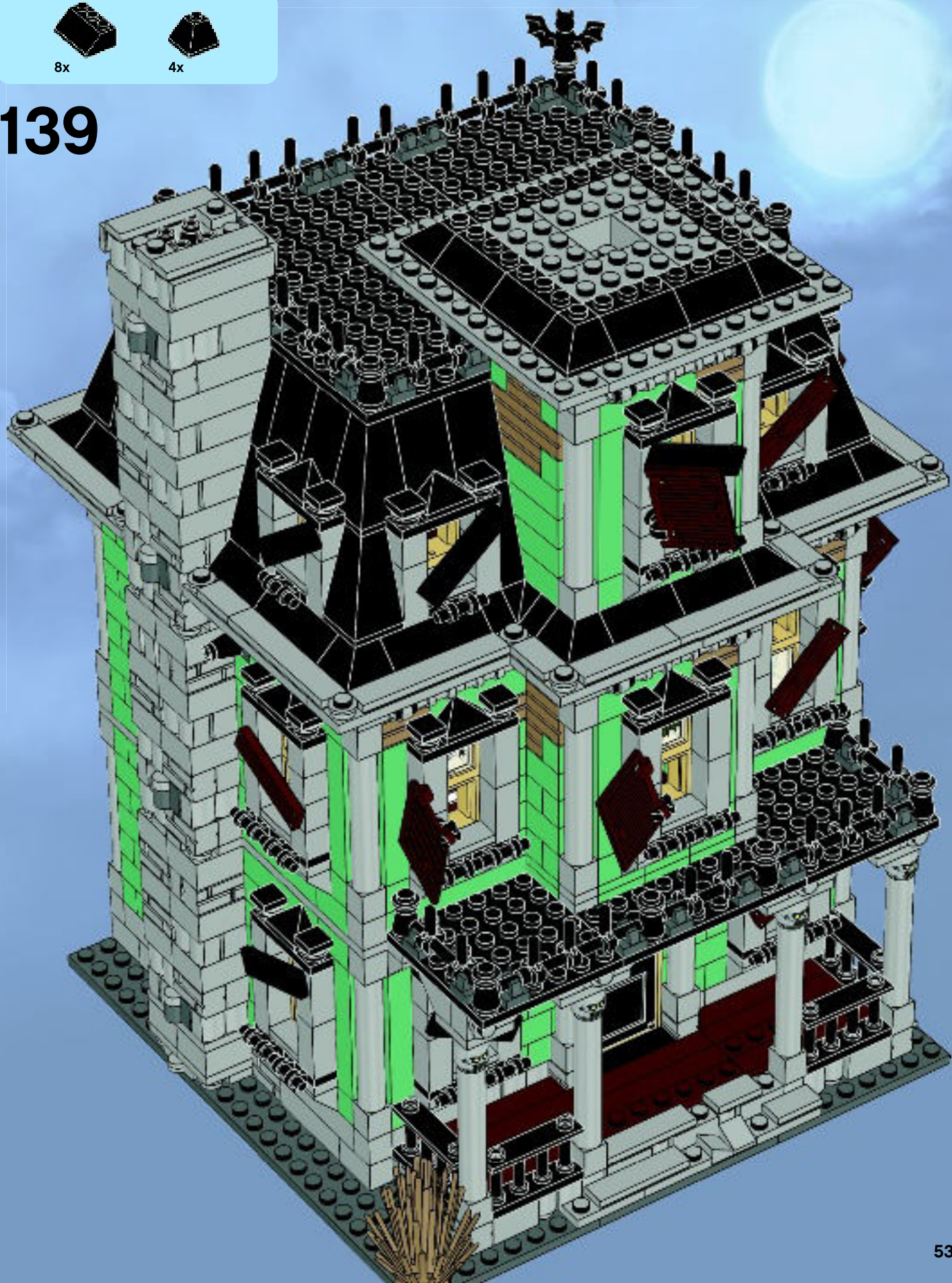



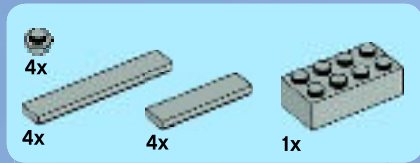

140

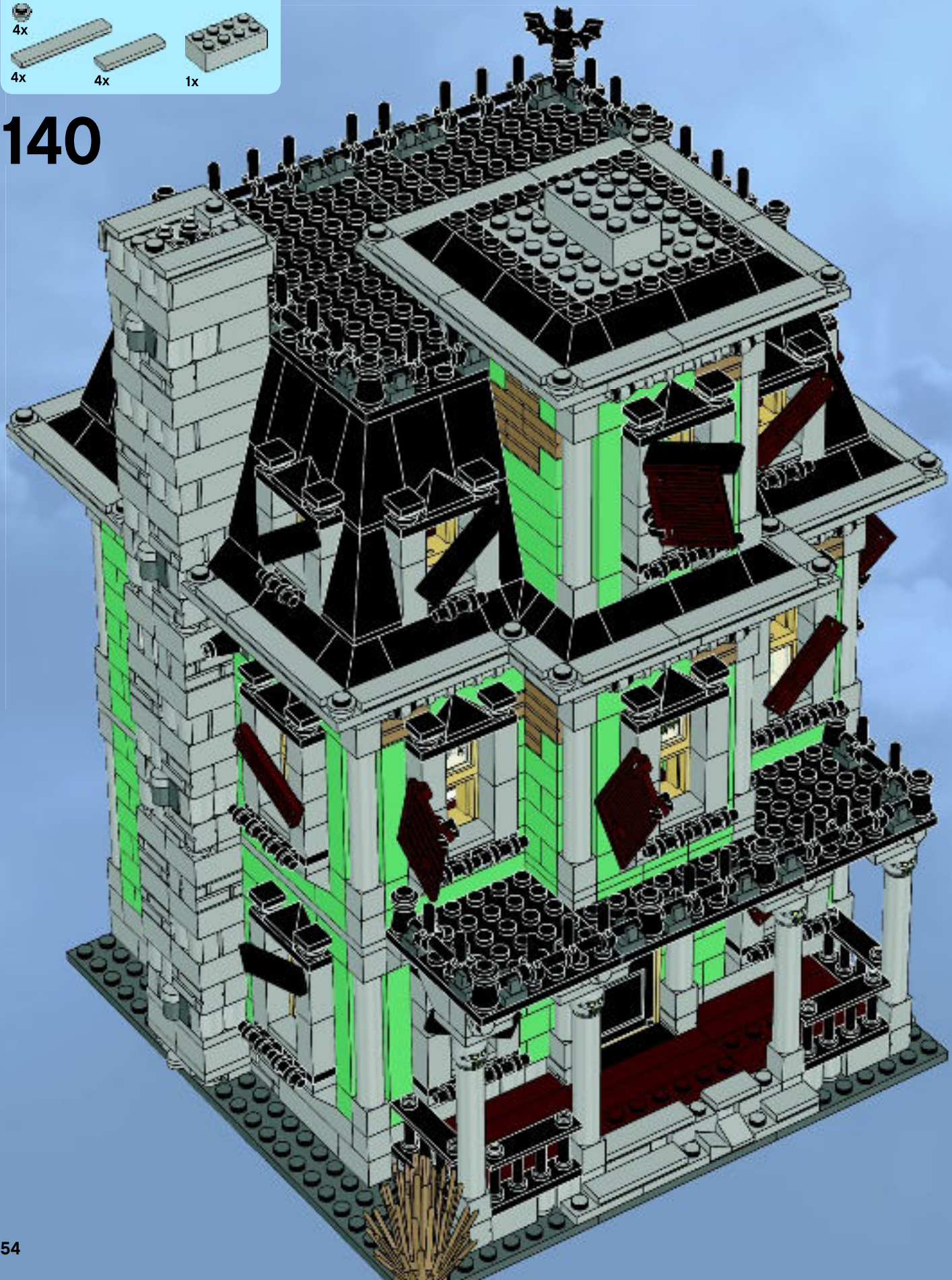



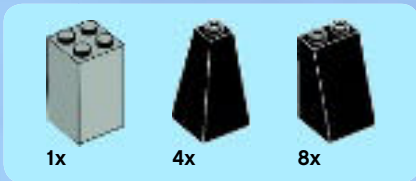

141

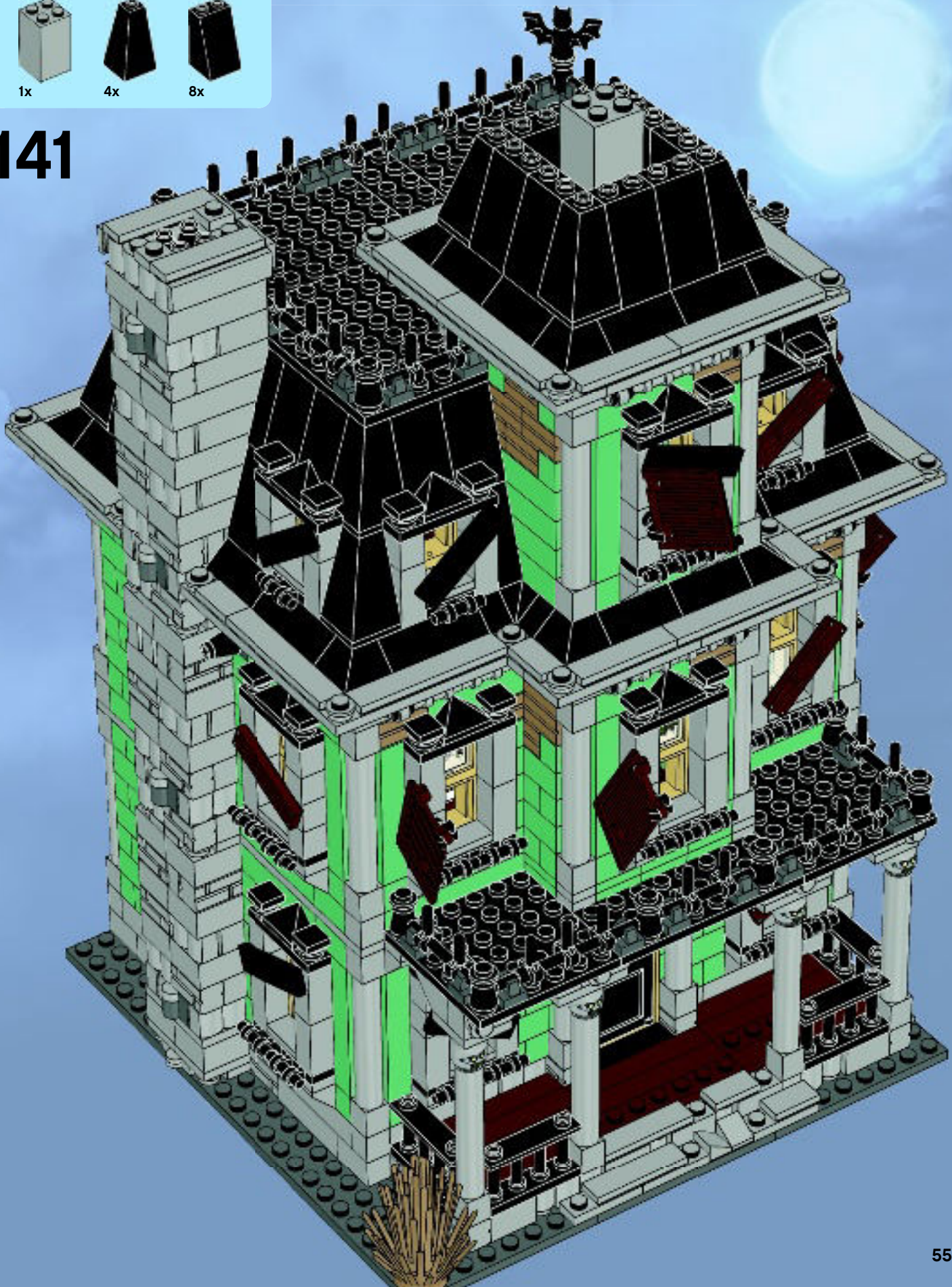



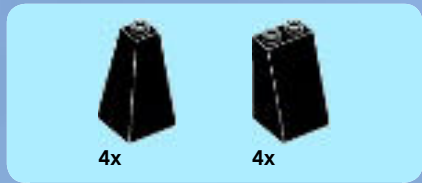

142

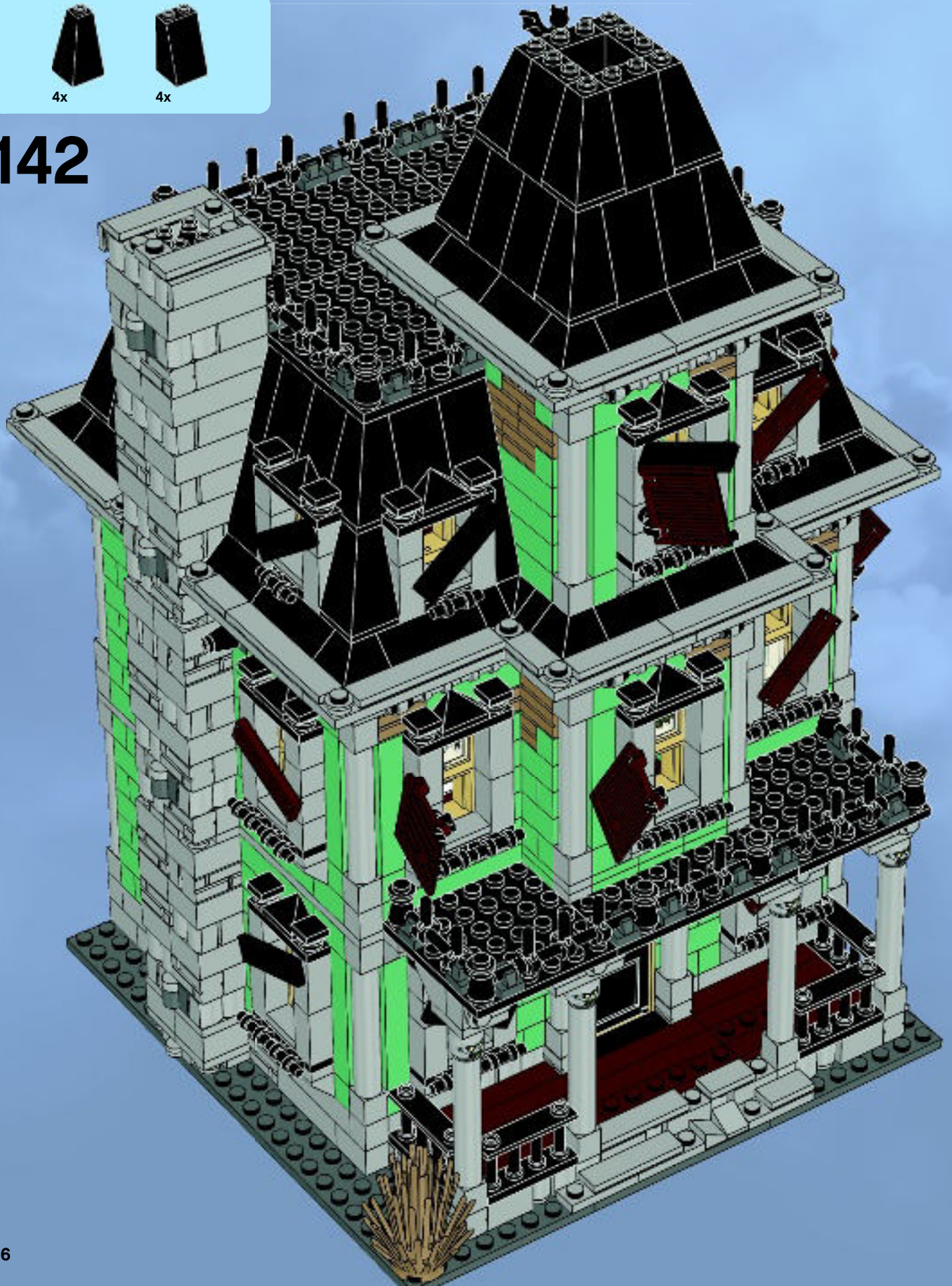





2x

# 143

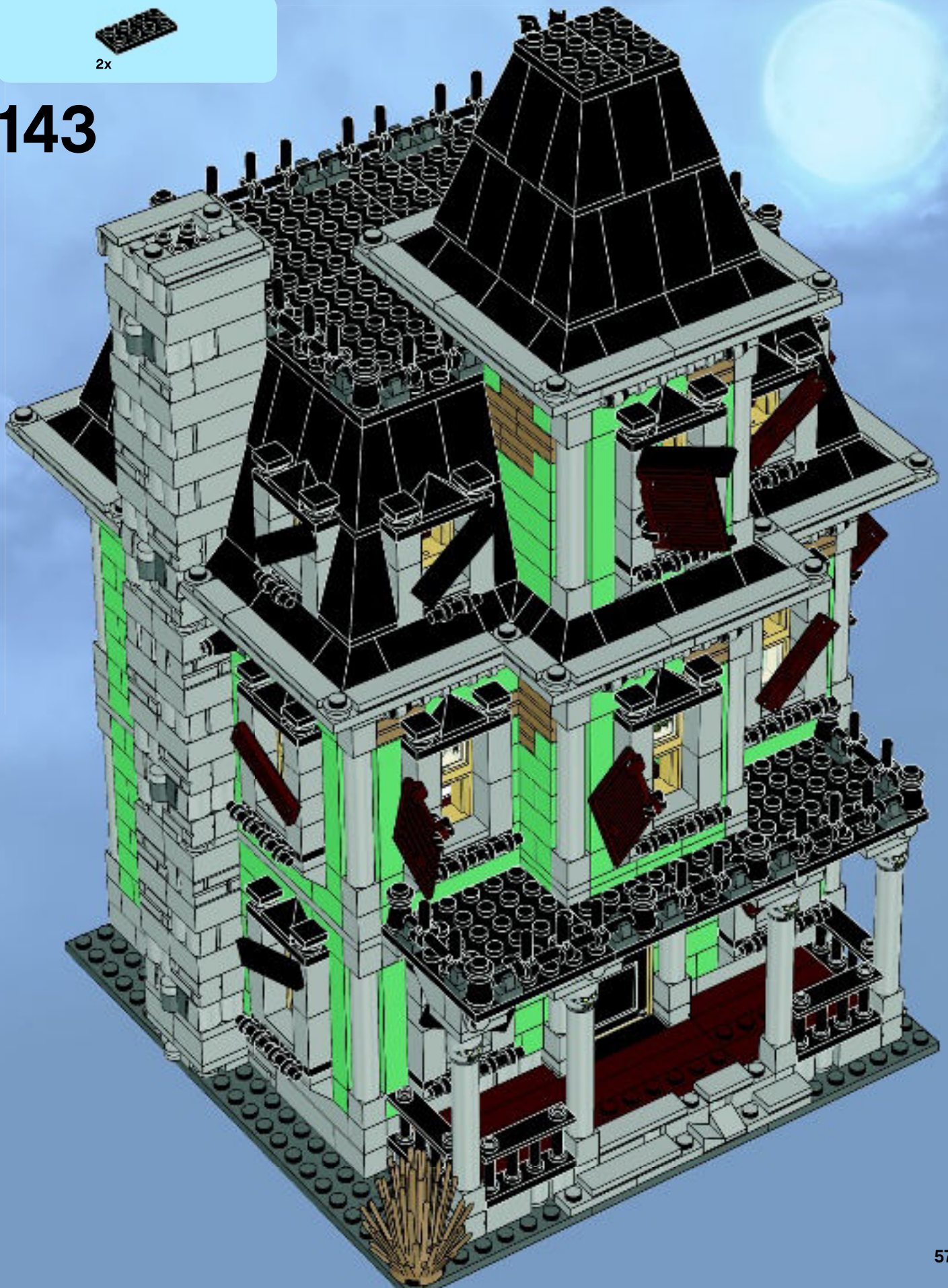





4x

144

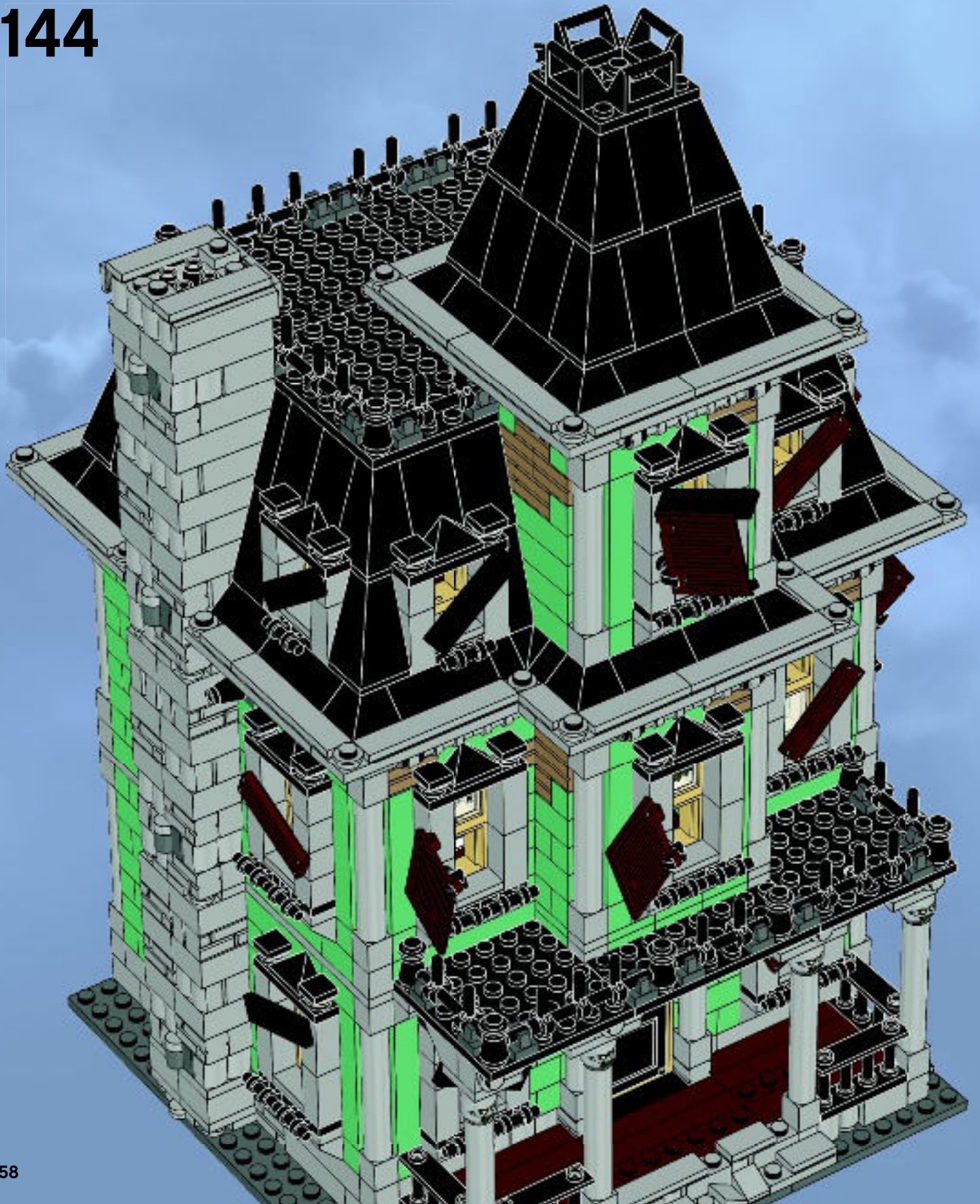



8x

4x

# 145



4x

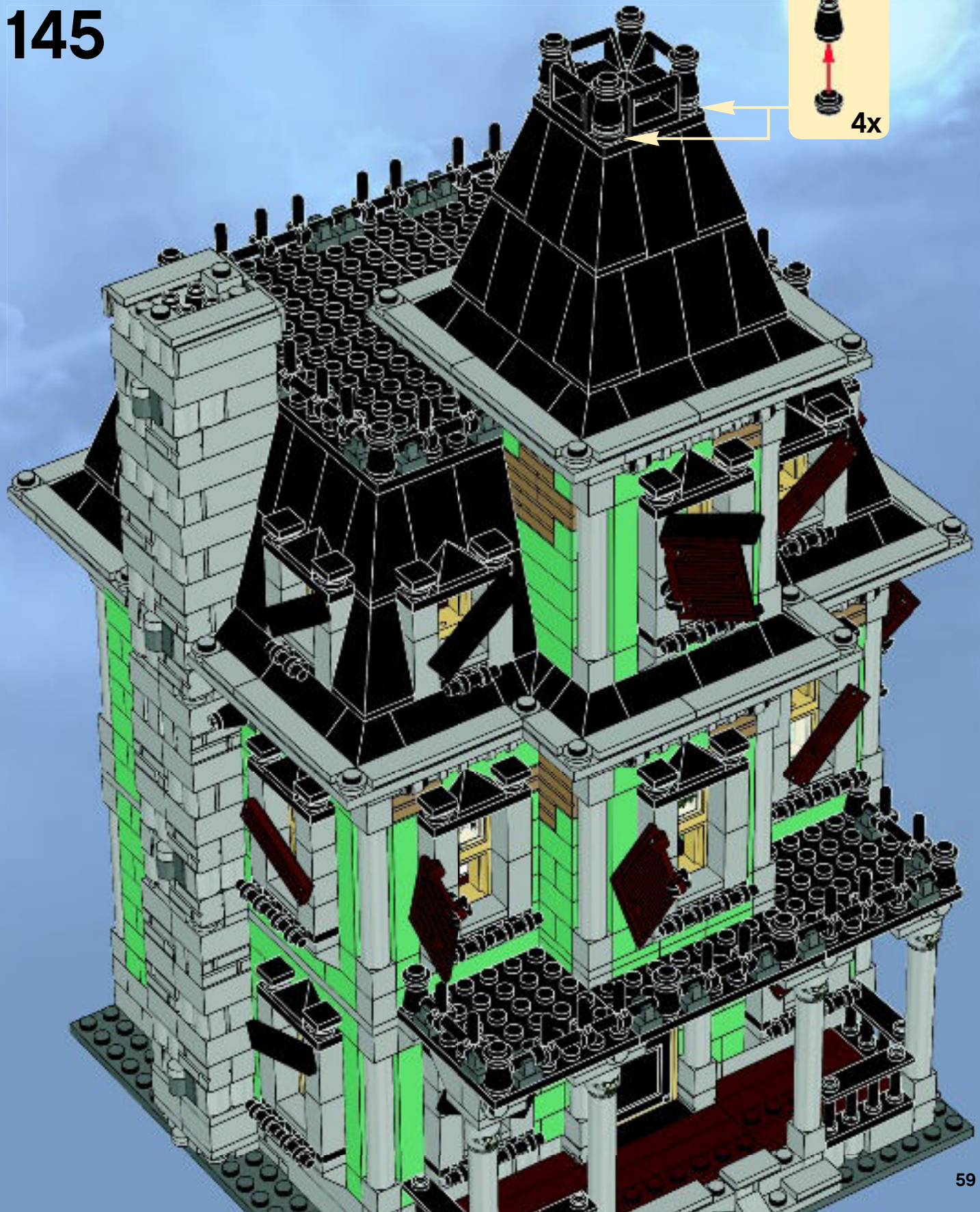



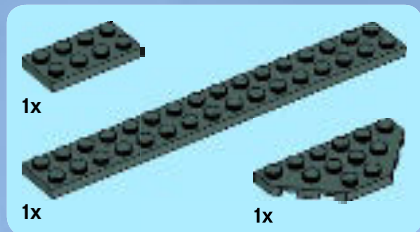
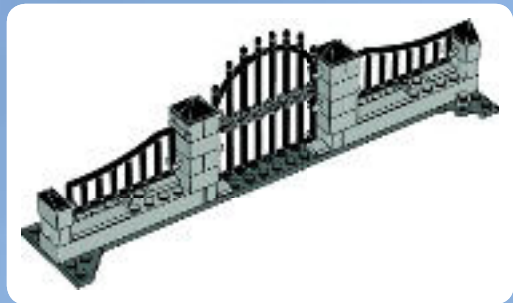

1

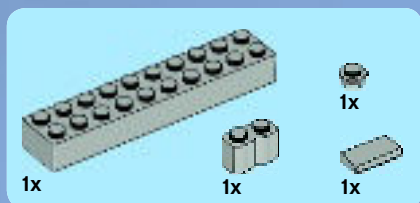
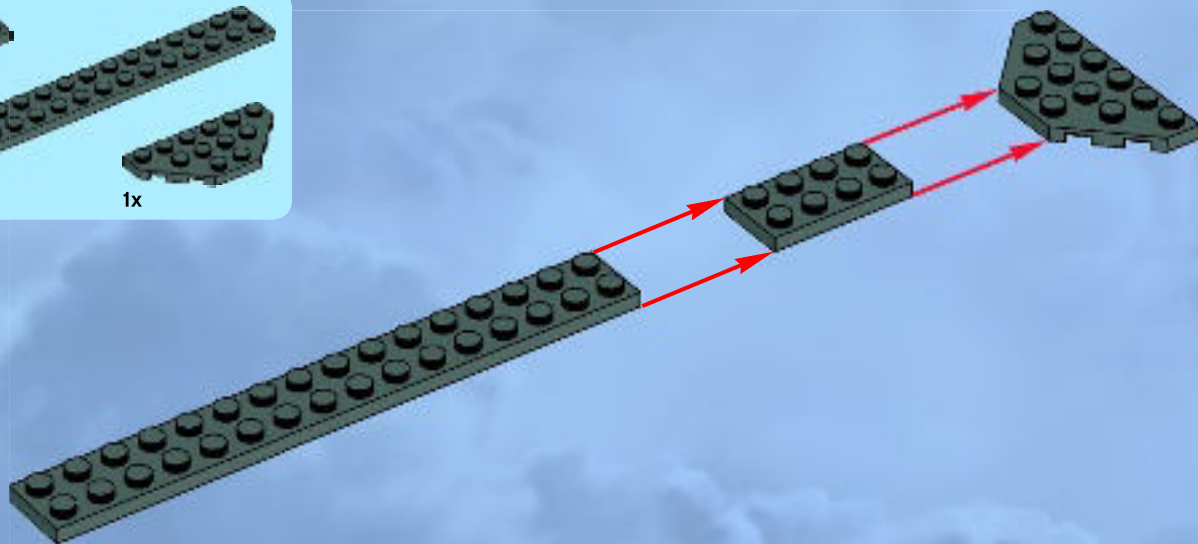

2

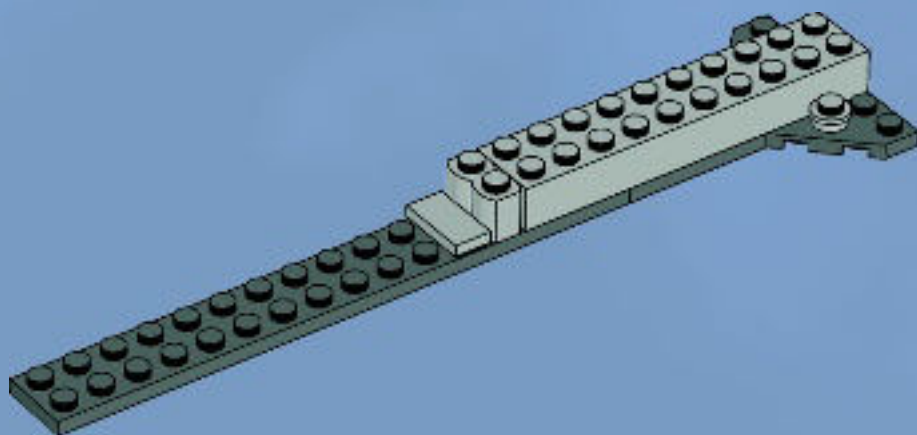

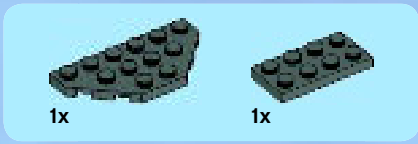

3

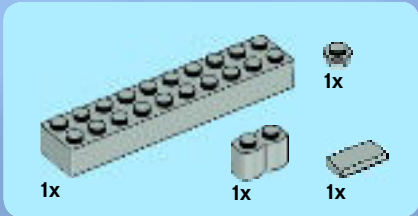
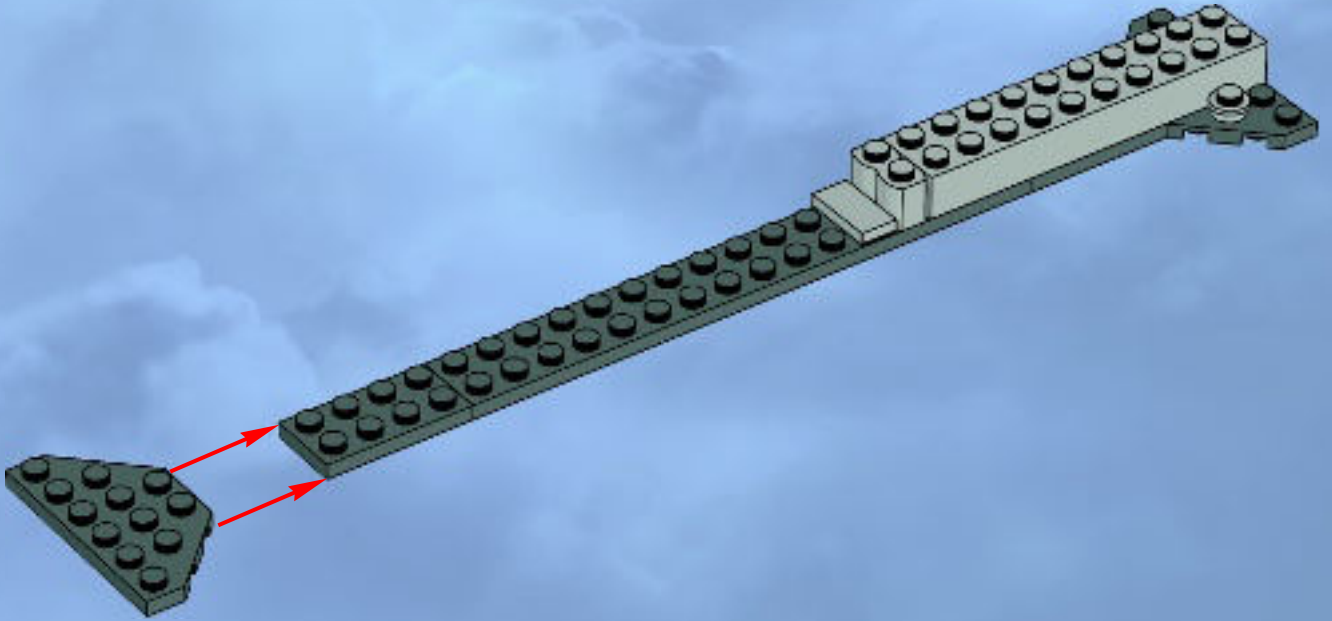

4

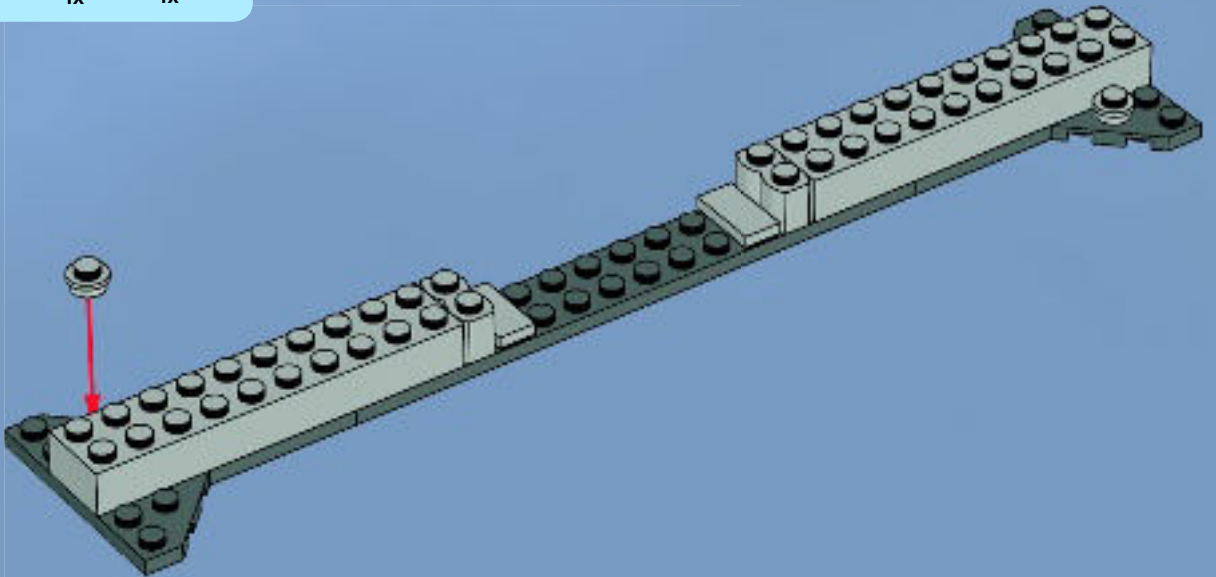



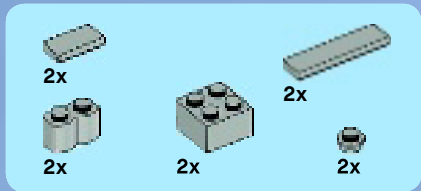

5

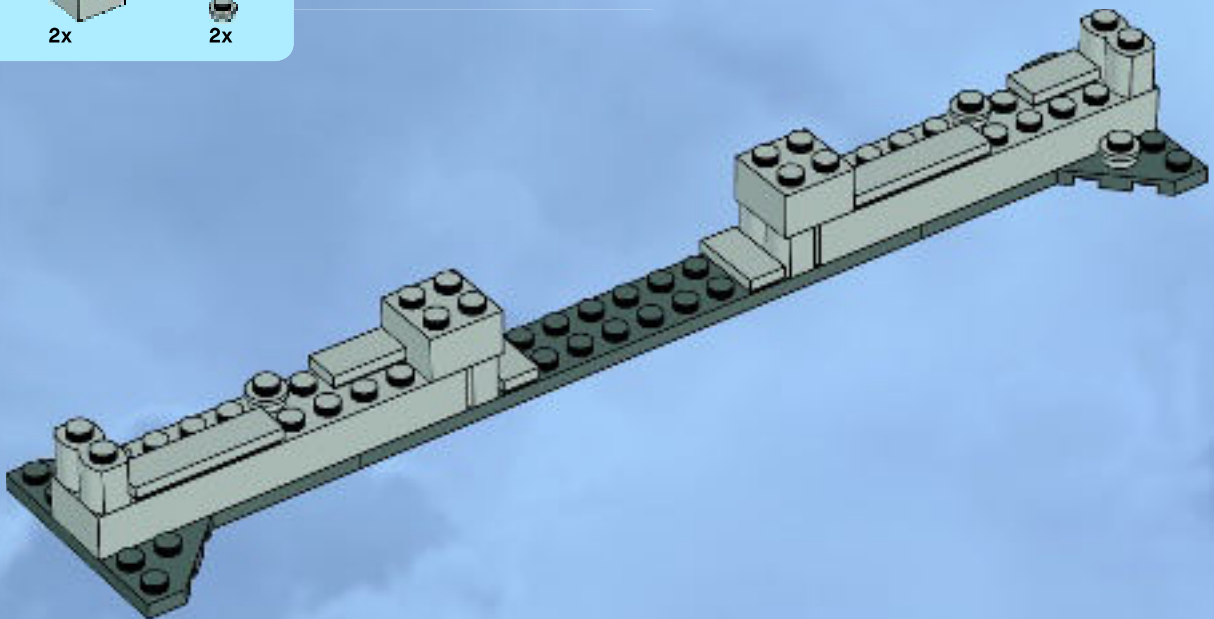

6

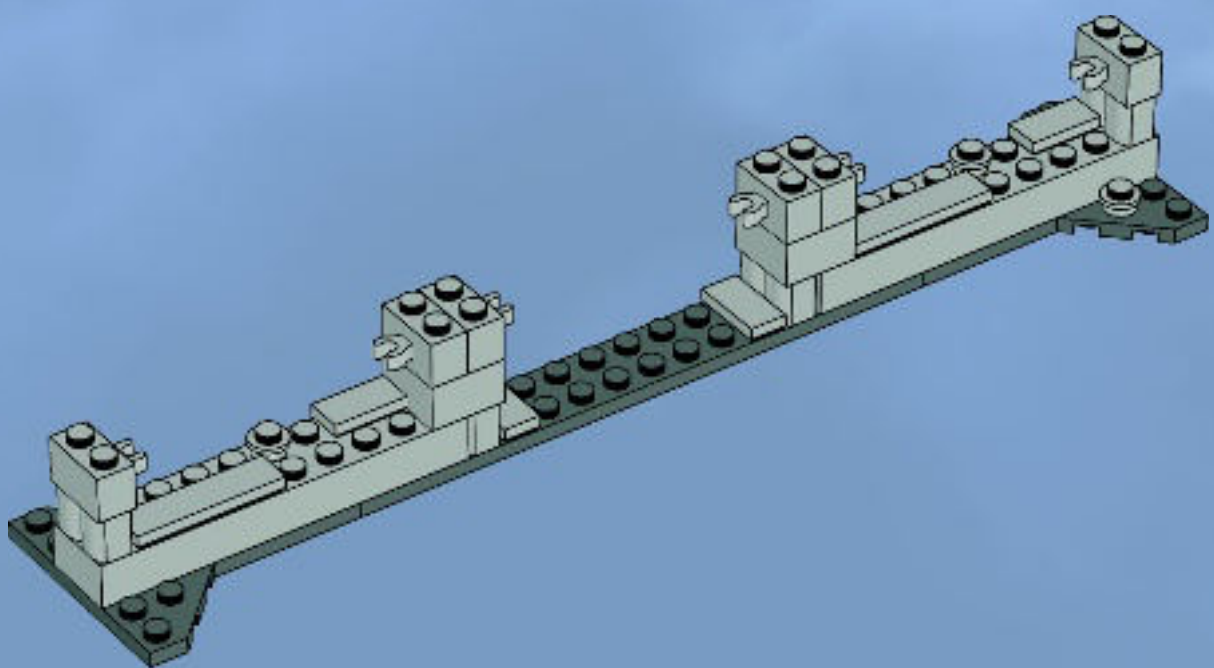



2x



2x

7

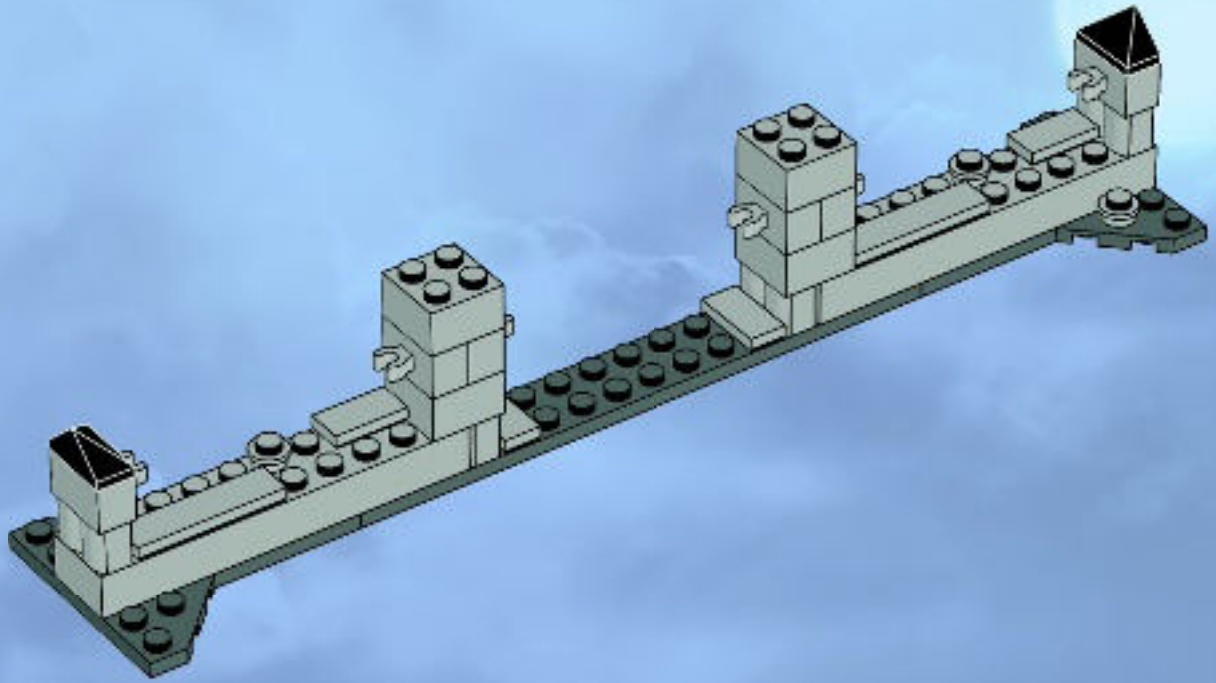

2x



2x

8

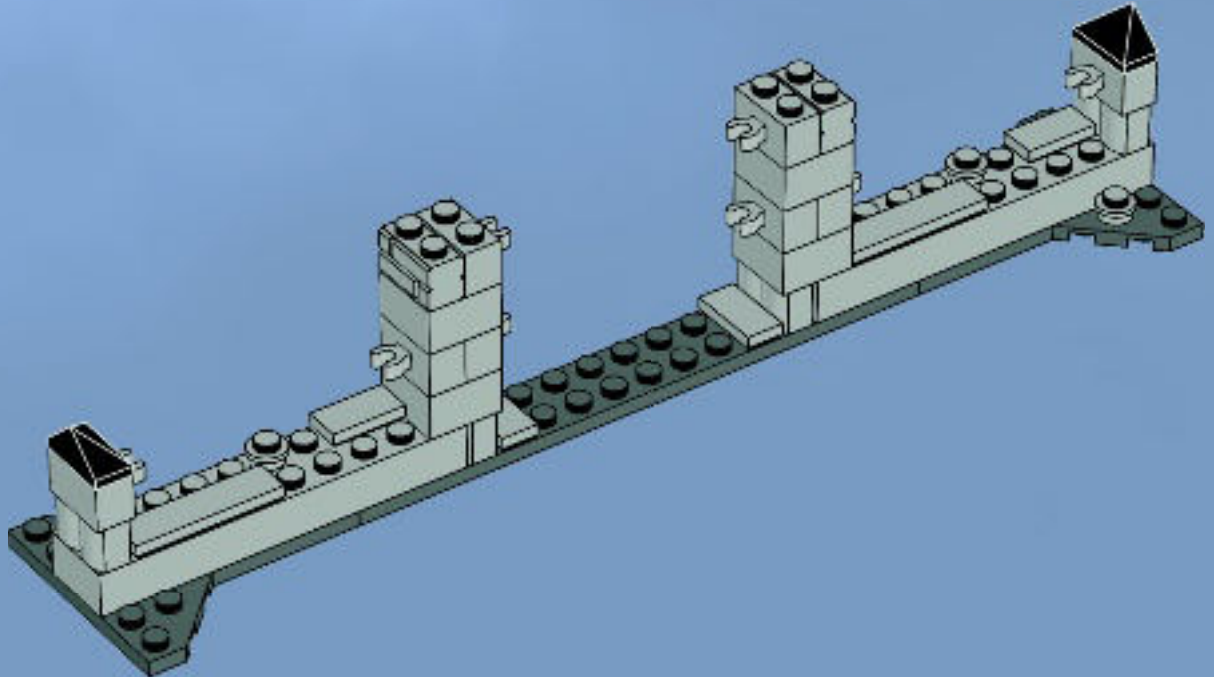



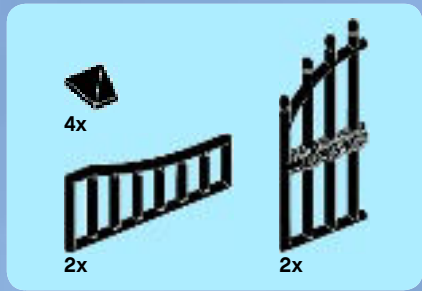

9

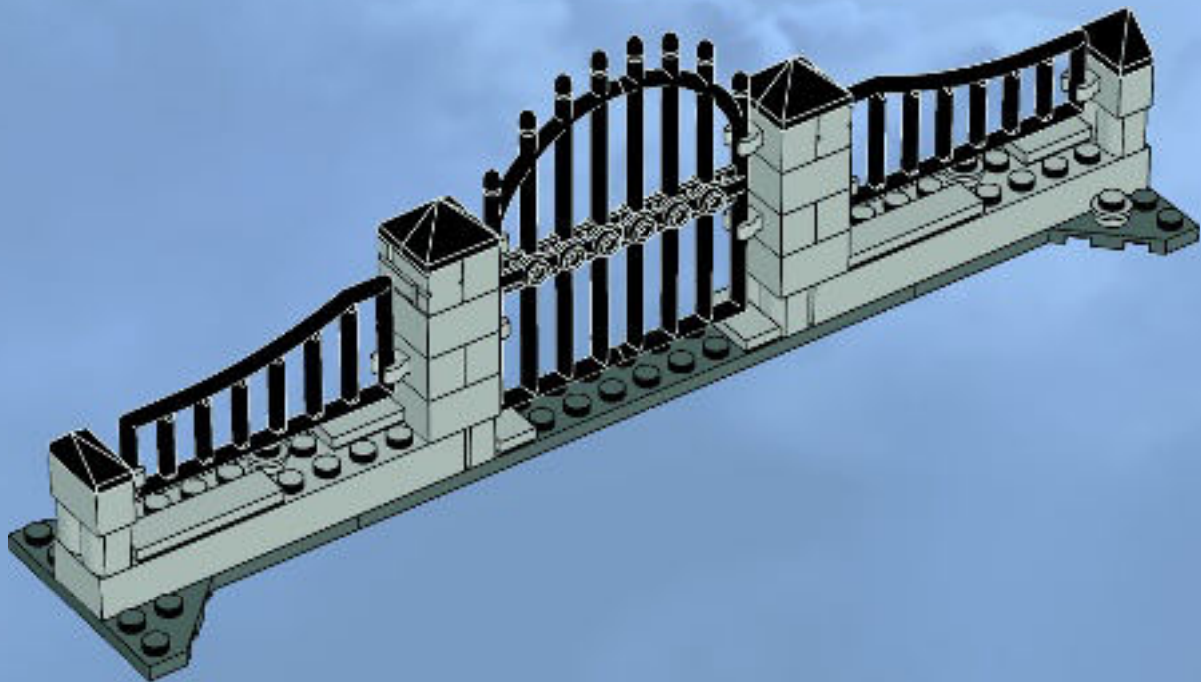

146

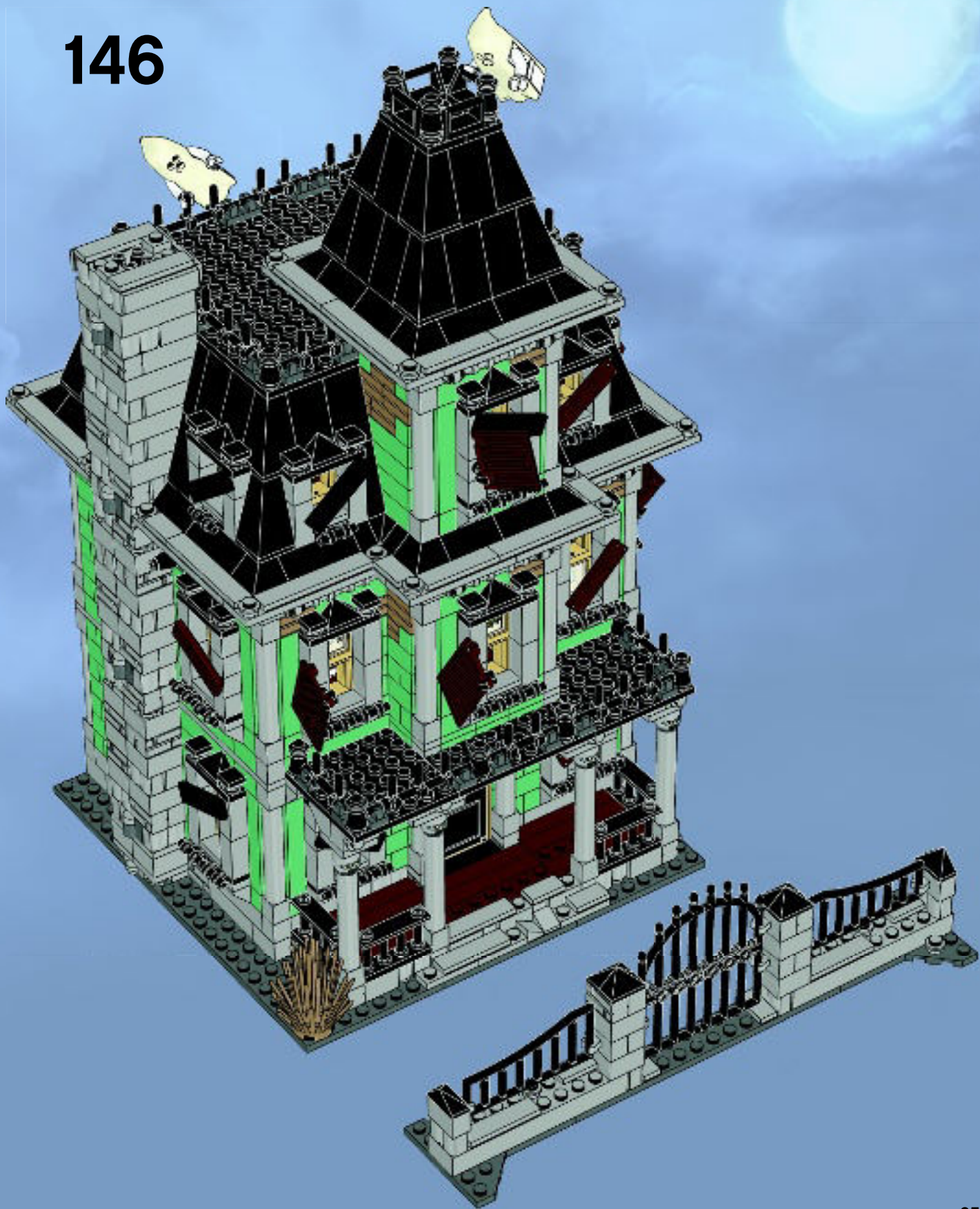



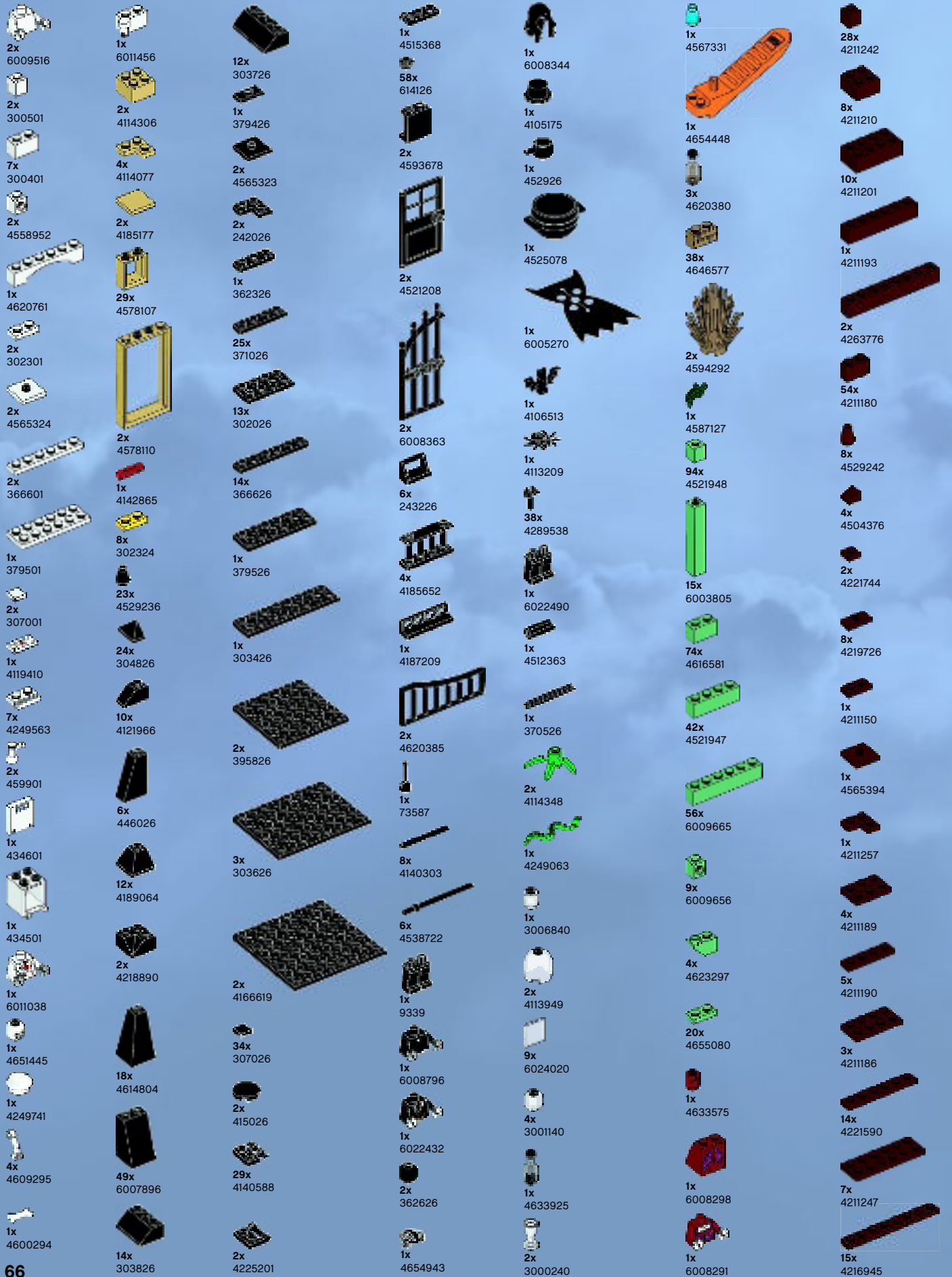

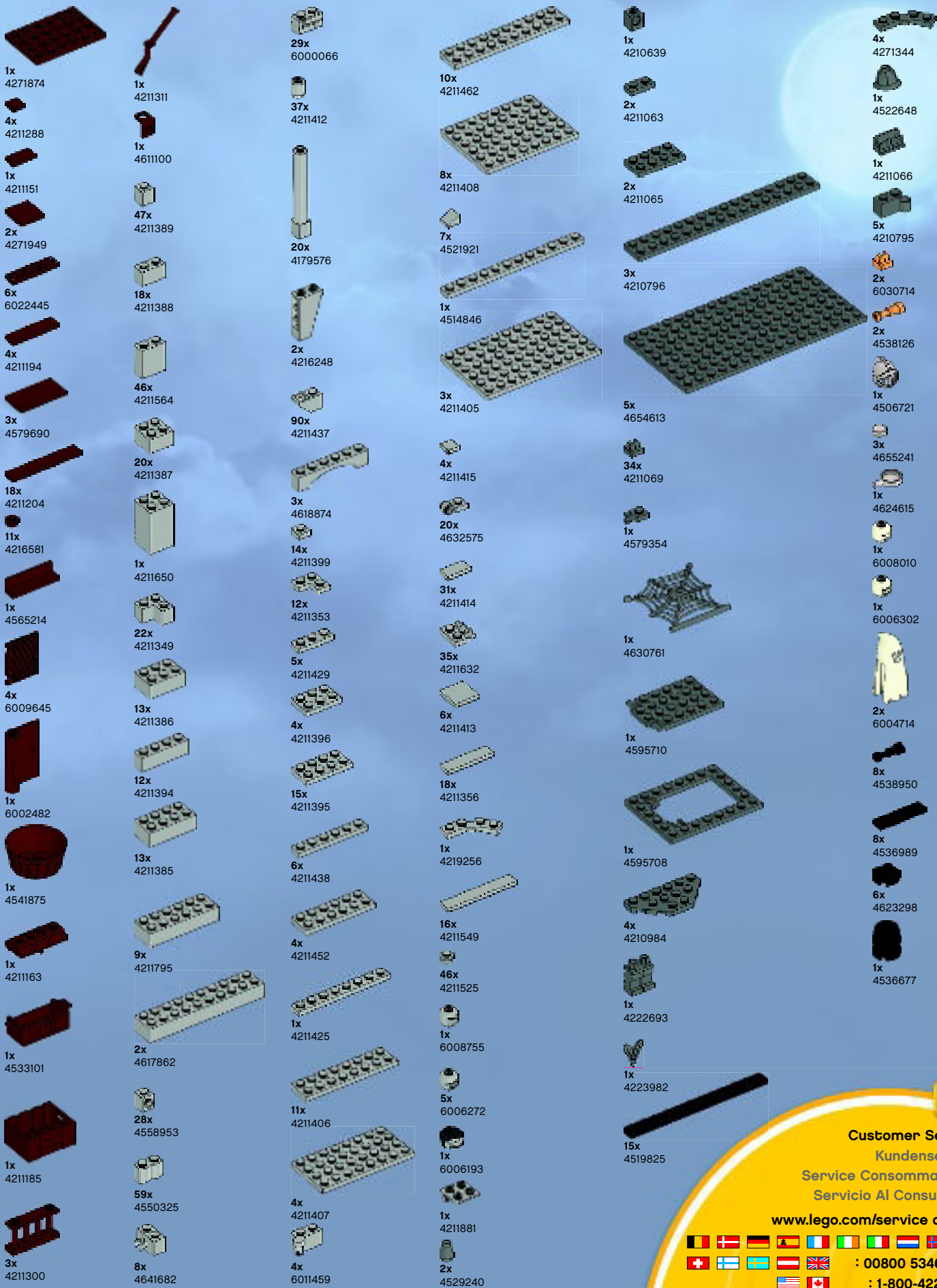

1x 4271874  
 4x 4211288  
 1x 4211151  
 2x 4271949  
 6x 6022445  
 4x 4211194  
 3x 4579690  
 18x 4211204  
 11x 4216581  
 1x 4565214  
 4x 6009645  
 1x 6002482  
 1x 4541875  
 1x 4211163  
 1x 4533101  
 1x 4211185  
 3x 4211300

1x 4211311  
 1x 4611100  
 47x 4211389  
 18x 4211388  
 46x 4211564  
 20x 4211387  
 1x 4211650  
 22x 4211349  
 13x 4211386  
 12x 4211394  
 13x 4211385  
 9x 4211795  
 2x 4617862  
 28x 4558953  
 59x 4550325  
 8x 4641682

29x 6000066  
 37x 4211412  
 20x 4179576  
 2x 4216248  
 90x 4211437  
 3x 4618874  
 14x 4211399  
 12x 4211353  
 5x 4211429  
 4x 4211396  
 15x 4211395  
 6x 4211438  
 4x 4211452  
 1x 4211425  
 11x 4211406  
 4x 4211407  
 4x 6011459

10x 4211462  
 8x 4211408  
 7x 4521921  
 1x 4514846  
 3x 4211405  
 4x 4211415  
 20x 4632575  
 31x 4211414  
 35x 4211632  
 6x 4211413  
 18x 4211356  
 1x 4219256  
 16x 4211549  
 46x 4211525  
 1x 6008755  
 5x 6006272  
 1x 6006193  
 1x 4211881  
 2x 4529240

1x 4210639  
 2x 4211063  
 2x 4211065  
 3x 4210796  
 5x 4654613  
 34x 4211069  
 1x 4579354  
 1x 4630761  
 1x 4595710  
 1x 4595708  
 4x 4210984  
 1x 4222693  
 1x 4223982  
 15x 4519825

4x 4271344  
 1x 4522648  
 1x 4211066  
 5x 4210795  
 2x 6030714  
 2x 4538126  
 1x 4506721  
 3x 4655241  
 1x 4624615  
 1x 6008010  
 1x 6006302  
 2x 6004714  
 8x 4538950  
 8x 4536989  
 6x 4623298  
 1x 4536677

  
**Customer Service**  
**Kundenservice**  
**Service Consommateurs**  
**Servicio Al Consumidor**  
[www.lego.com/service](http://www.lego.com/service) or dial  
 : 00800 5346 5555  
 : 1-800-422-5346





# WIN!

Go to [www.LEGOsurvey.com/product](http://www.LEGOsurvey.com/product) to fill out a survey for a chance to win a cool LEGO® Product.

No purchase necessary.

Open to all residents where not prohibited.

 [www.LEGO.com](http://www.LEGO.com)



## [www.LEGOsurvey.com/product](http://www.LEGOsurvey.com/product)

### GEWINNE!

Nimm an der Umfrage auf [www.LEGOsurvey.com/product](http://www.LEGOsurvey.com/product) teil und hab die Chance ein cooles LEGO® Produkt zu gewinnen!  
Die Teilnahme am Gewinnspiel führt zu keinerlei Kaufverpflichtungen. Teilnahme in allen nicht ausgeschlossenen Ländern möglich.

### WIN!

Ga naar [www.LEGOsurvey.com/product](http://www.LEGOsurvey.com/product), vul een enquêteformulier in en maak kans op een cool LEGO® product.  
Geen aankoopverplichting.  
Iedereen mag deelnemen, uitgezonderd ingezetenden van landen waar een enquêteverbod geldt.

### GAGNE!

Visite [www.LEGOsurvey.com/product](http://www.LEGOsurvey.com/product) pour répondre à un questionnaire et avoir une chance de gagner un produit LEGO® très cool!  
Aucune obligation d'achat.  
Ouvert à tous les résidents des pays autorisés.

### 当てよう!

[www.LEGOsurvey.com/product](http://www.LEGOsurvey.com/product) にアクセスして、アンケートにご記入ください。当選者にはレゴ®製品を差し上げます。  
お買い上げの必要はありません。  
禁止されていない限り、すべての皆様にご利用いただけます。