



# MONSTER FIGHTERS

9468



1

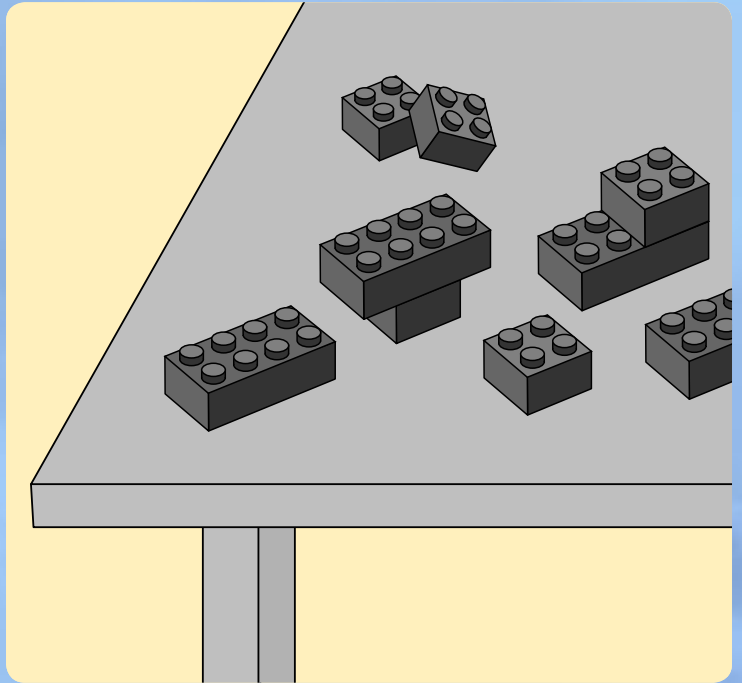
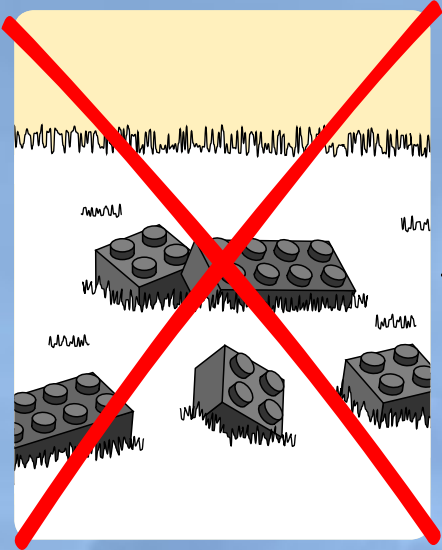

2

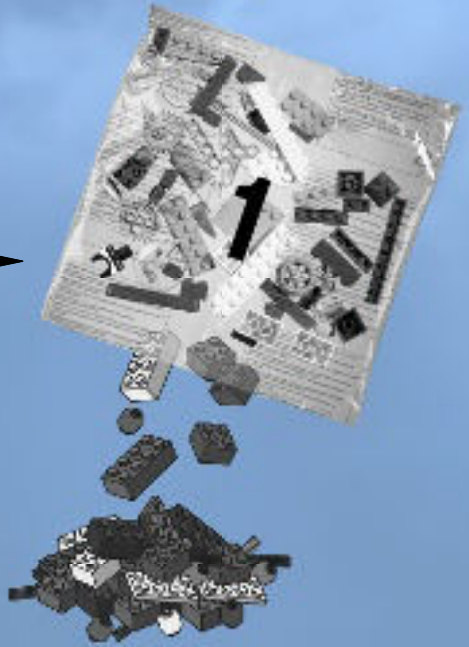

<http://lego.com/brickseparator>



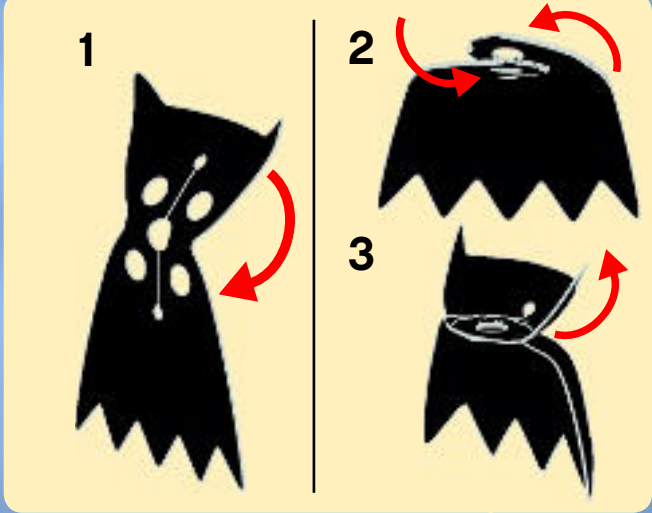

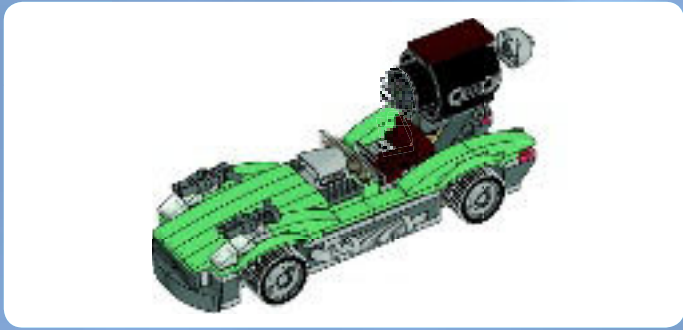
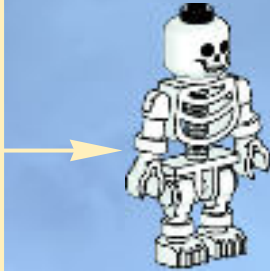
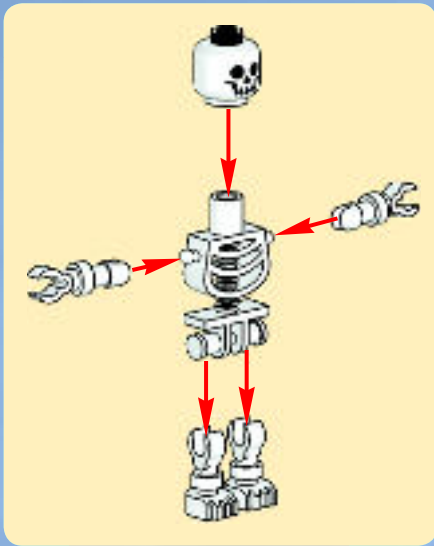

1

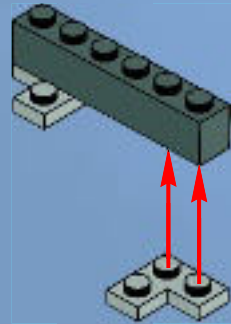





2

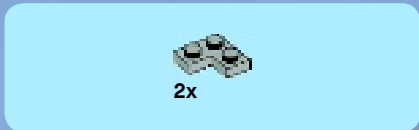
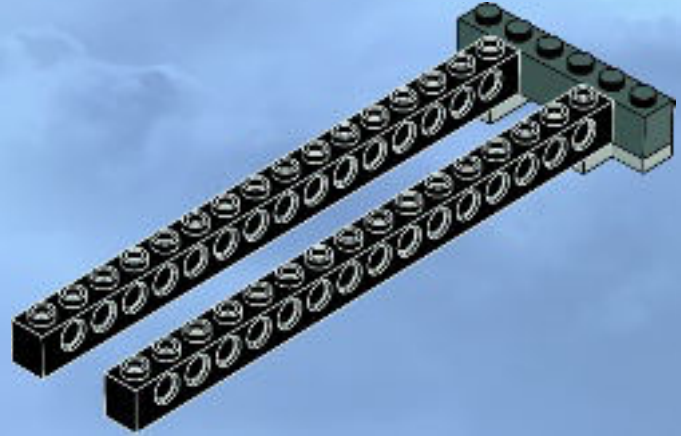

3

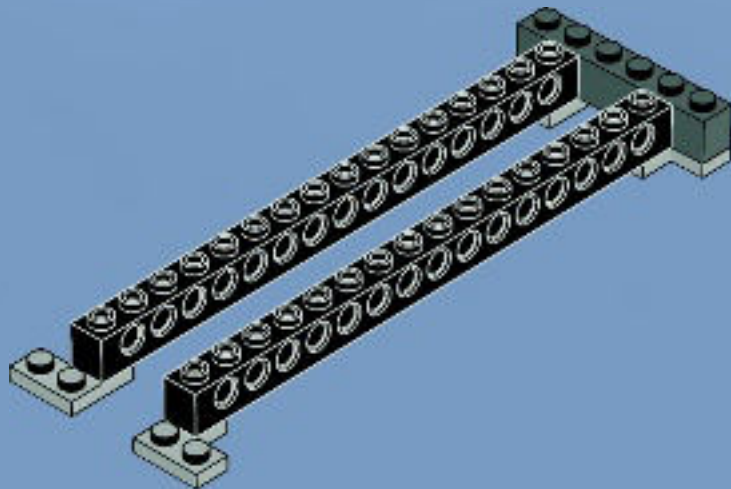



2x

4

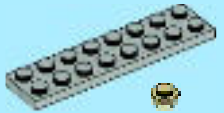
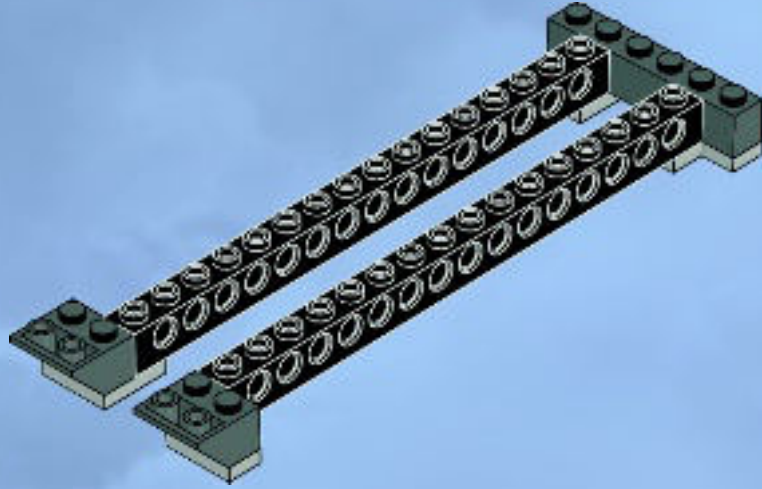

2x



4x



2x

5

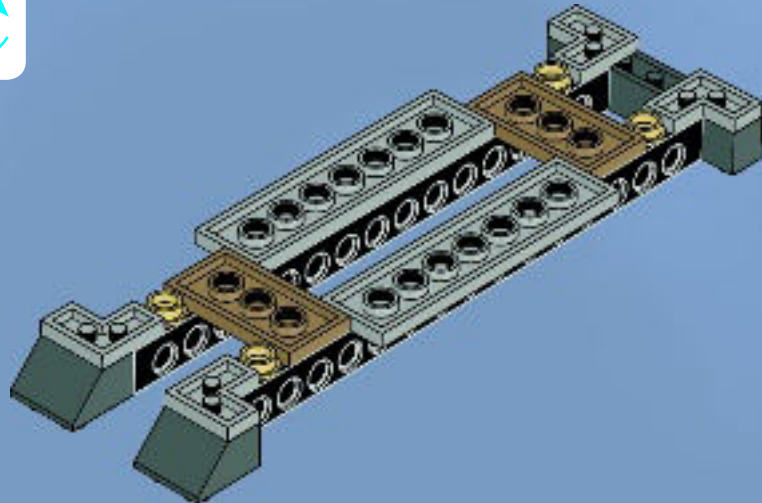



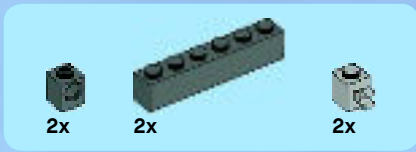

6

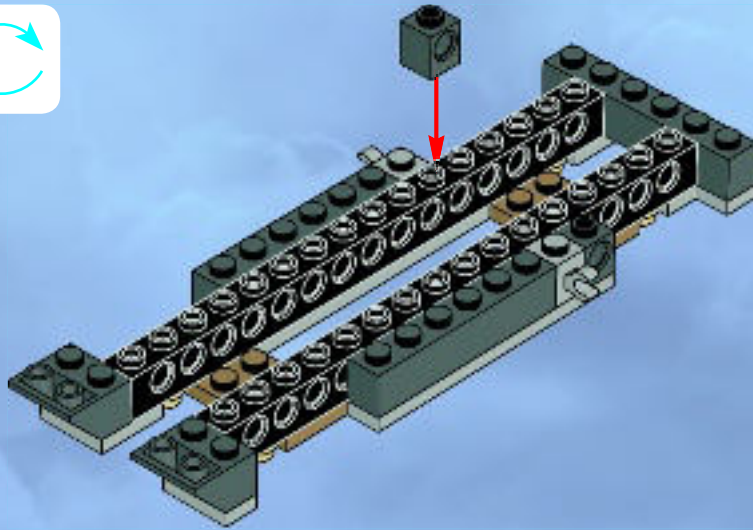

7

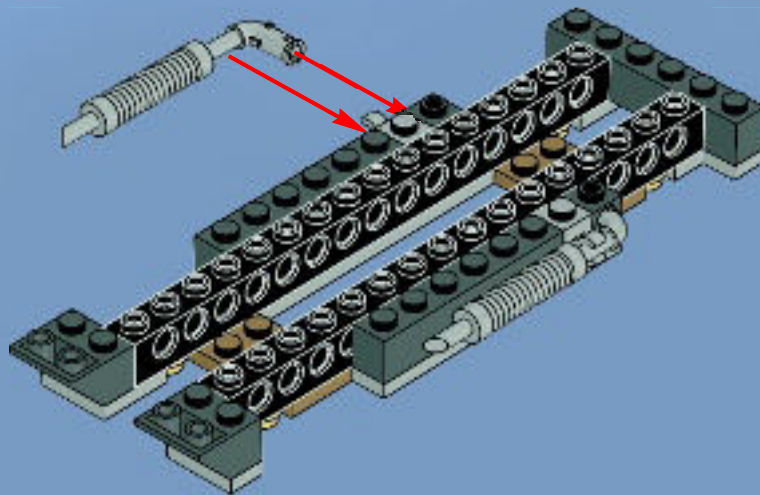



2x



2x

# 8

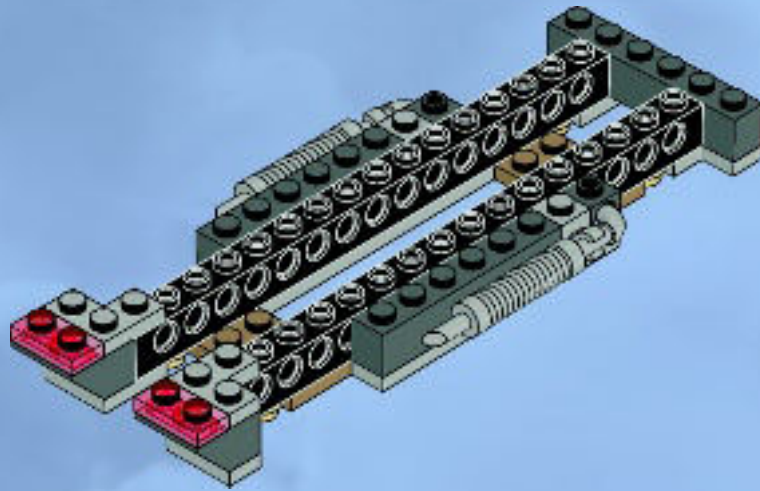

2x

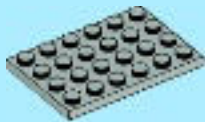

1x

# 9

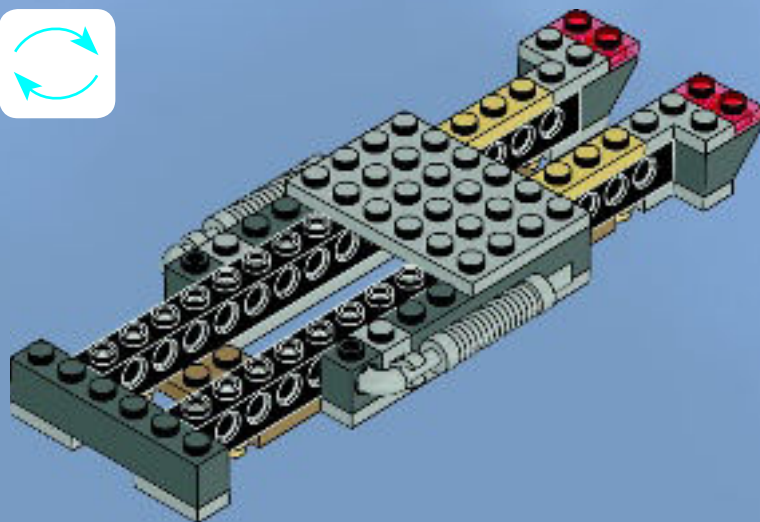





2x

# 10

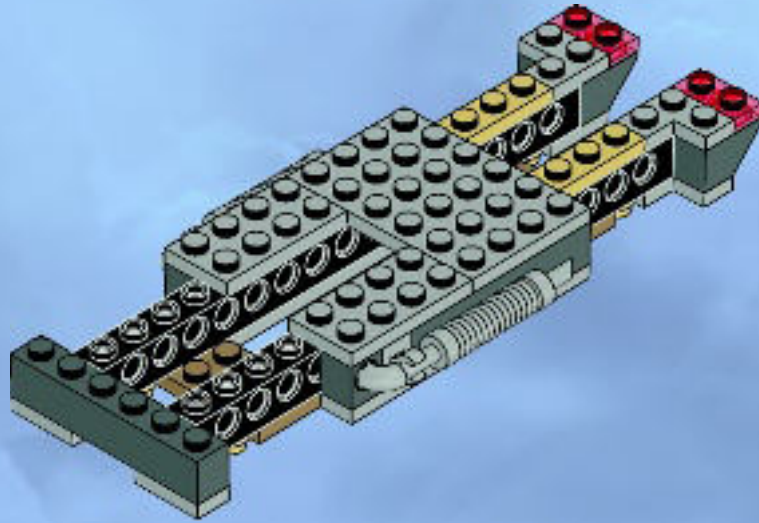

2x



1x

# 11

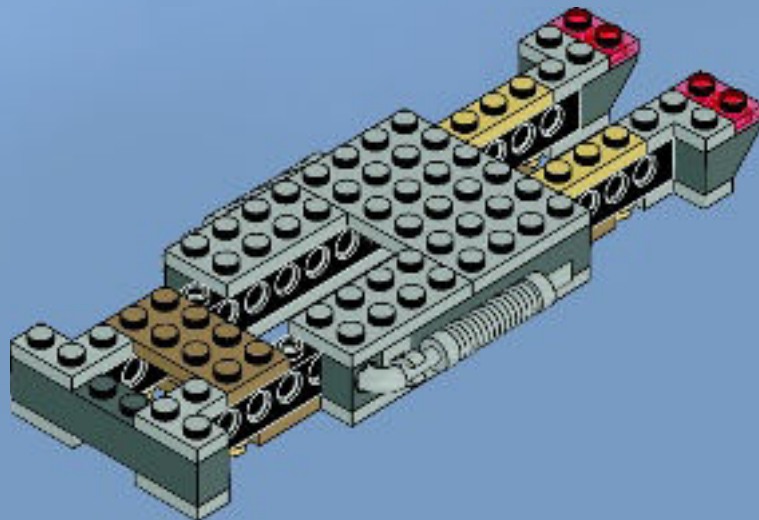

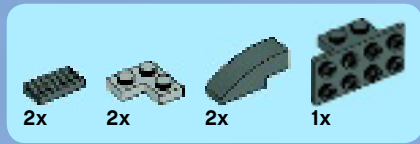

# 12

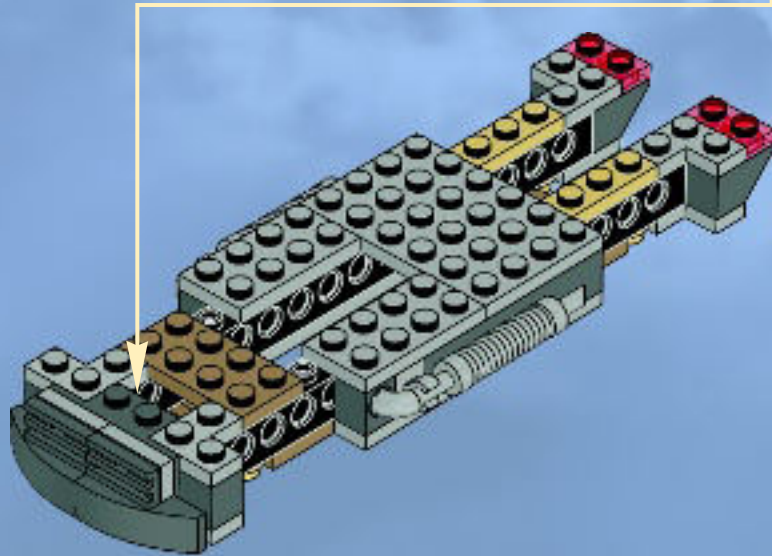
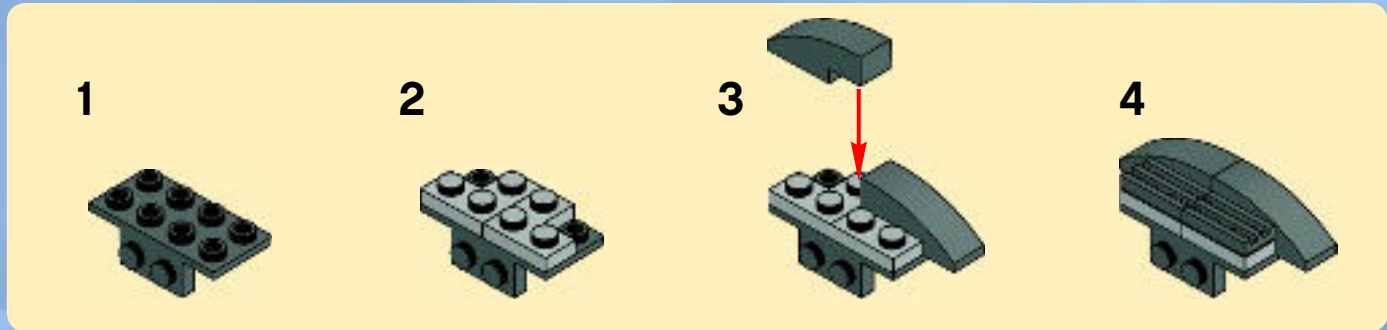



1x 2x 1x 2x

13

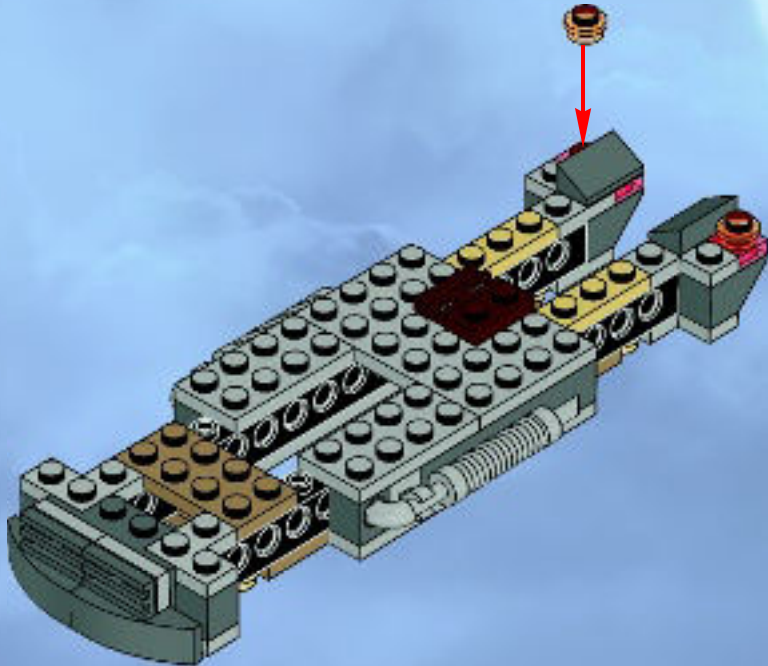

1x

14

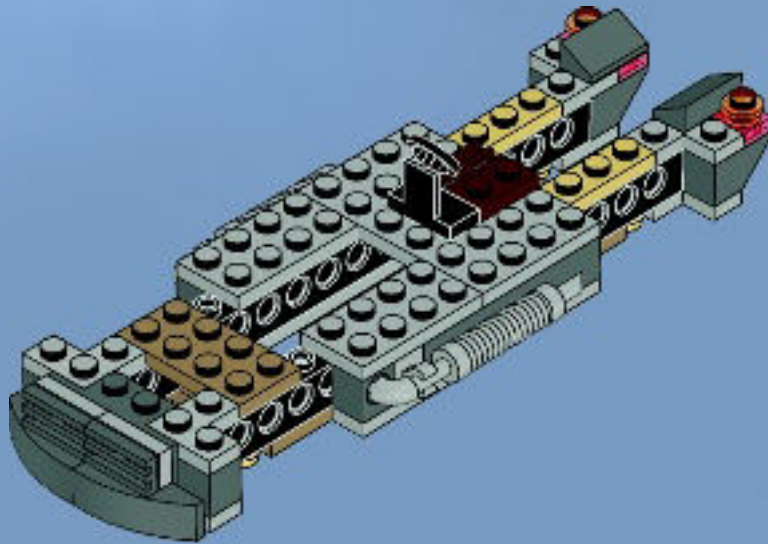



4x

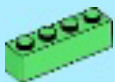

1x

# 15

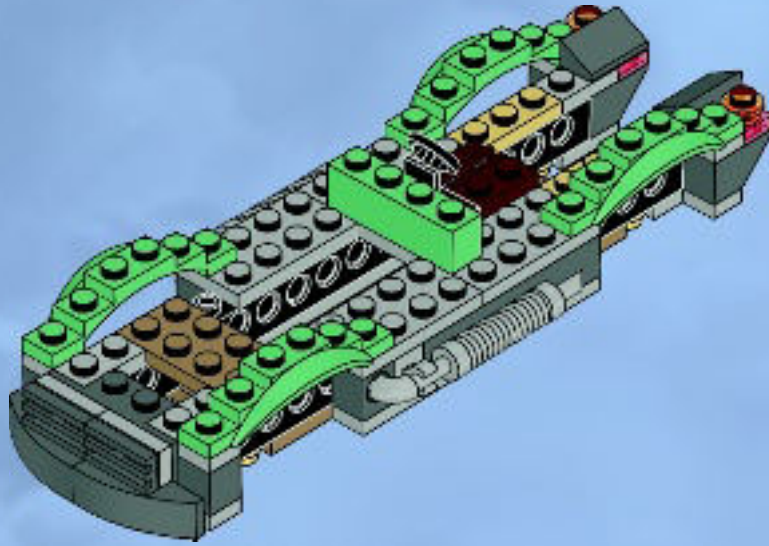

1x



4x

# 16

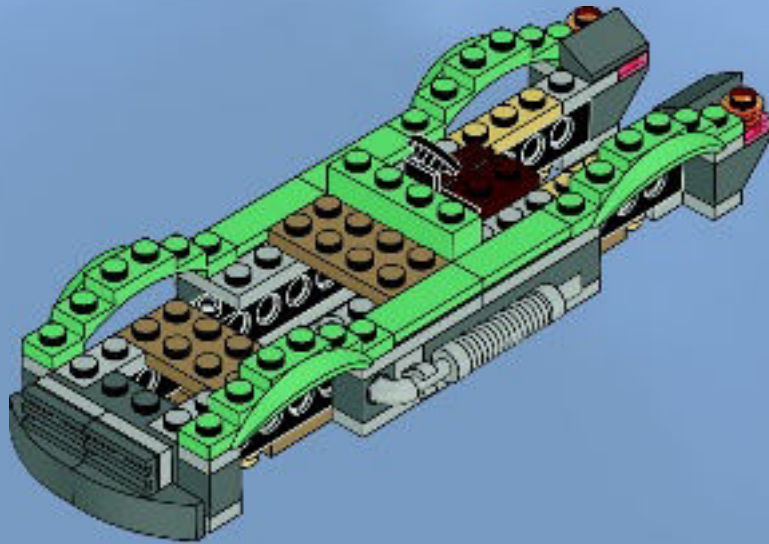



2x



4x

# 17

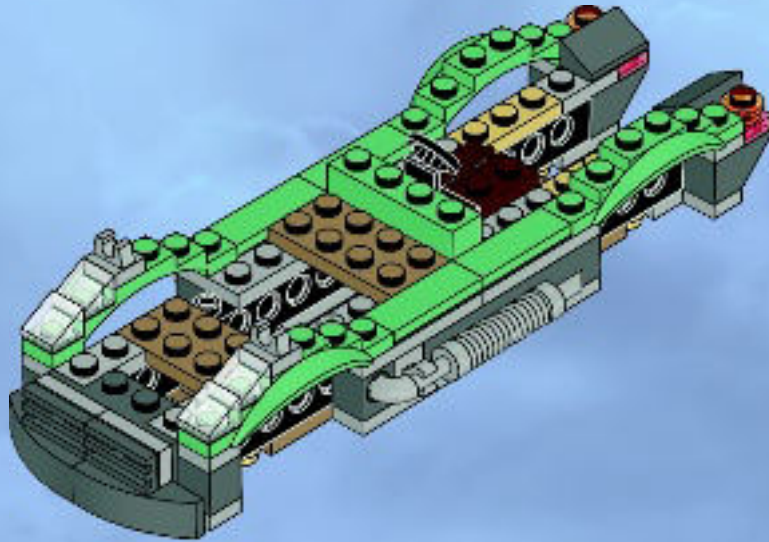

6x

# 18

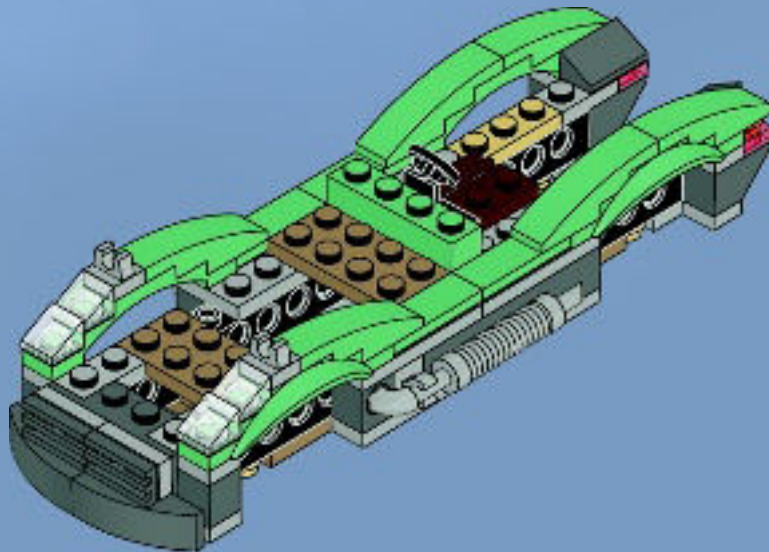



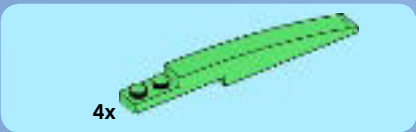

# 19

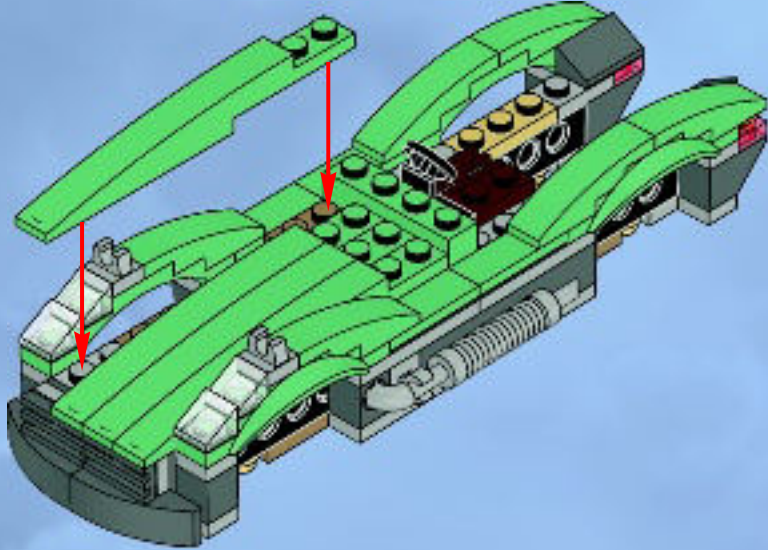

# 20

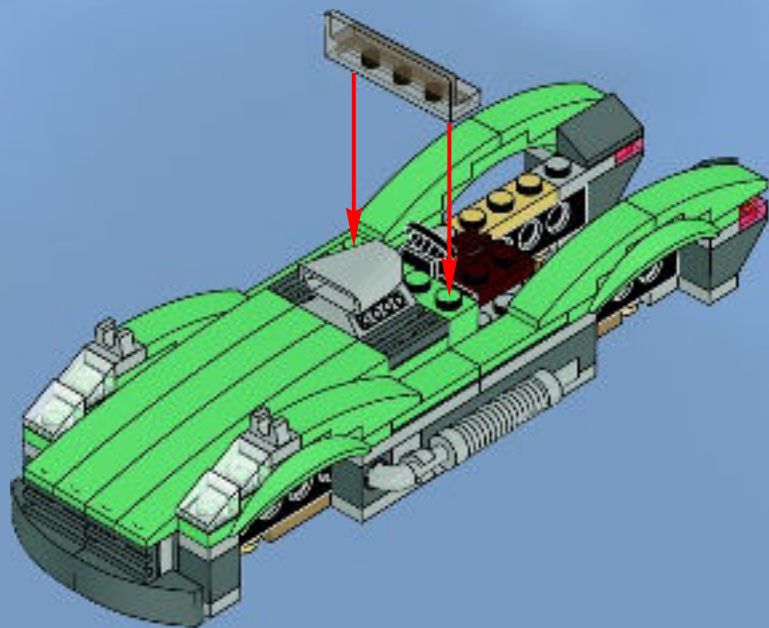



# 21

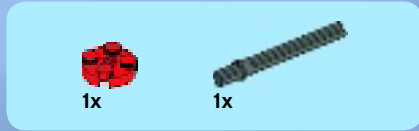
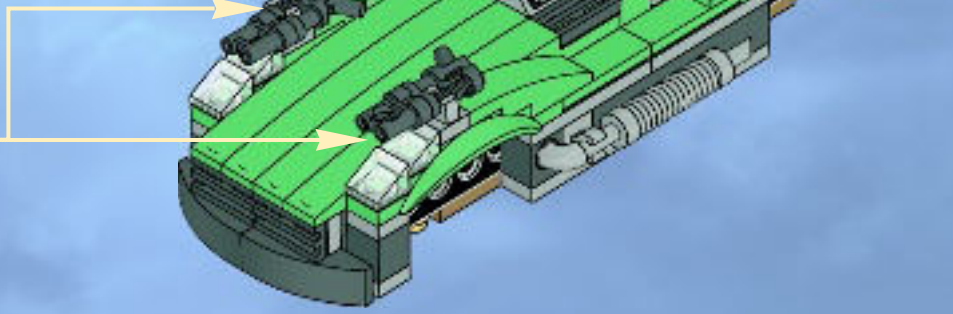
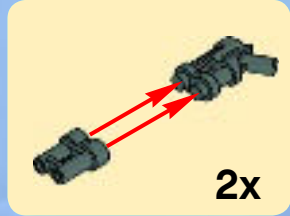

# 1

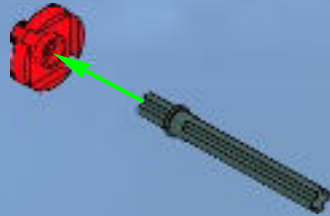

# 2

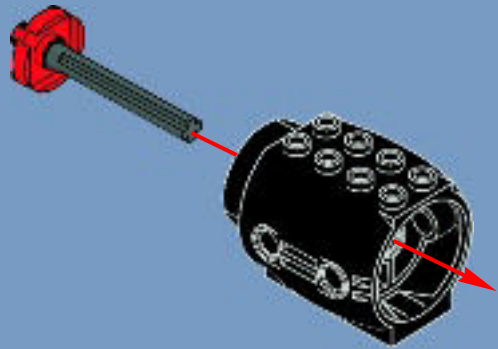



3

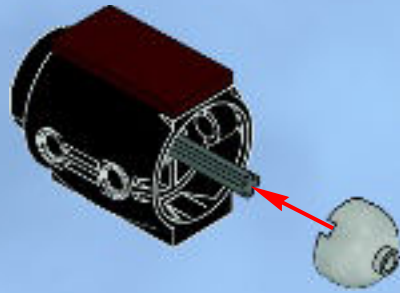

4

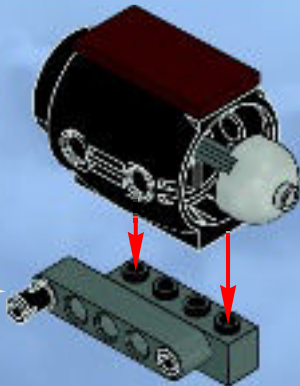
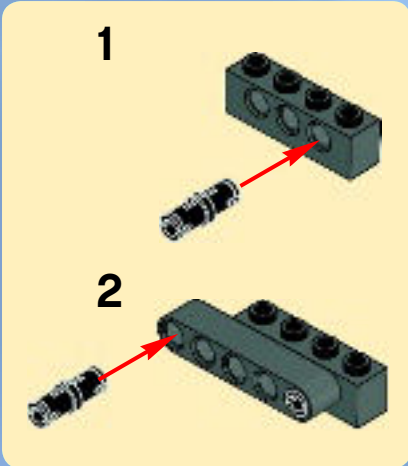

5

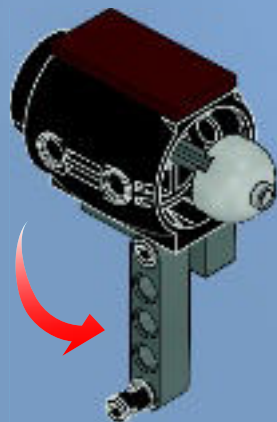



# 22

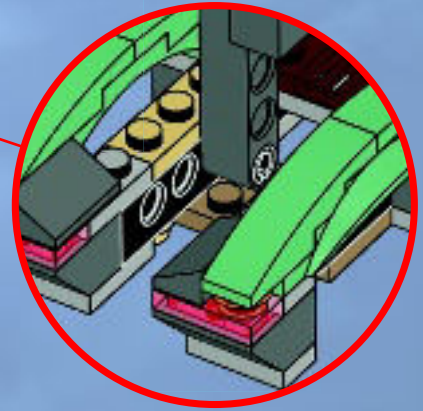
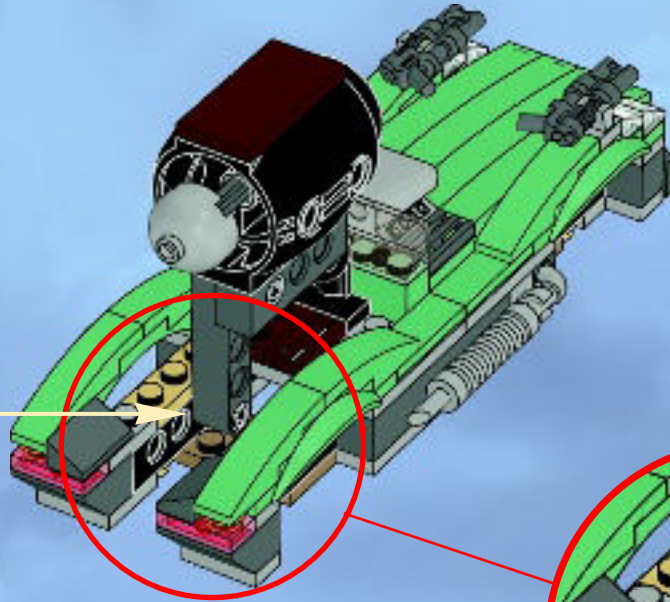

# 23

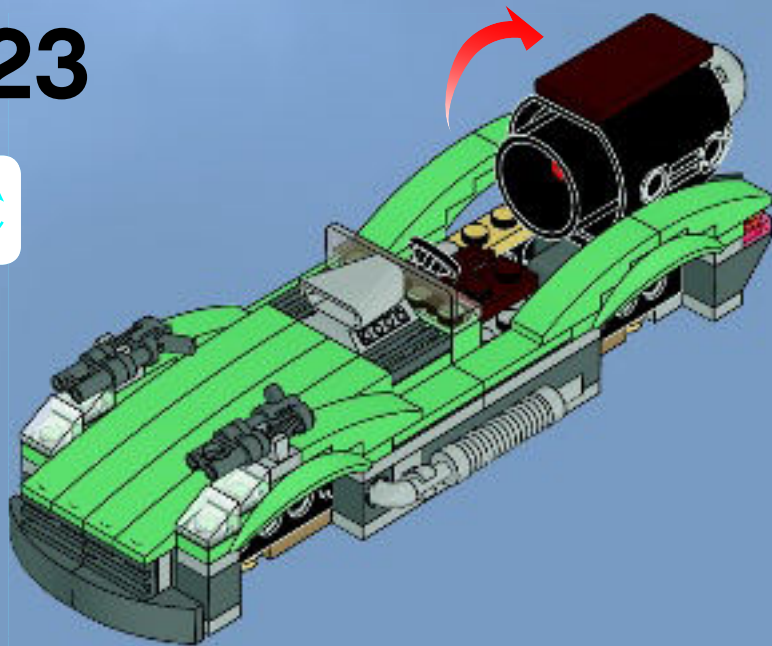



# 24

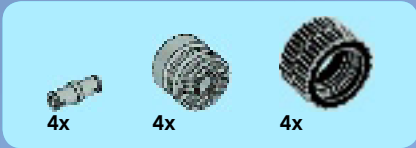
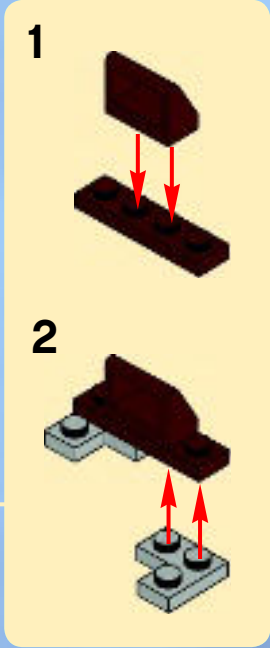
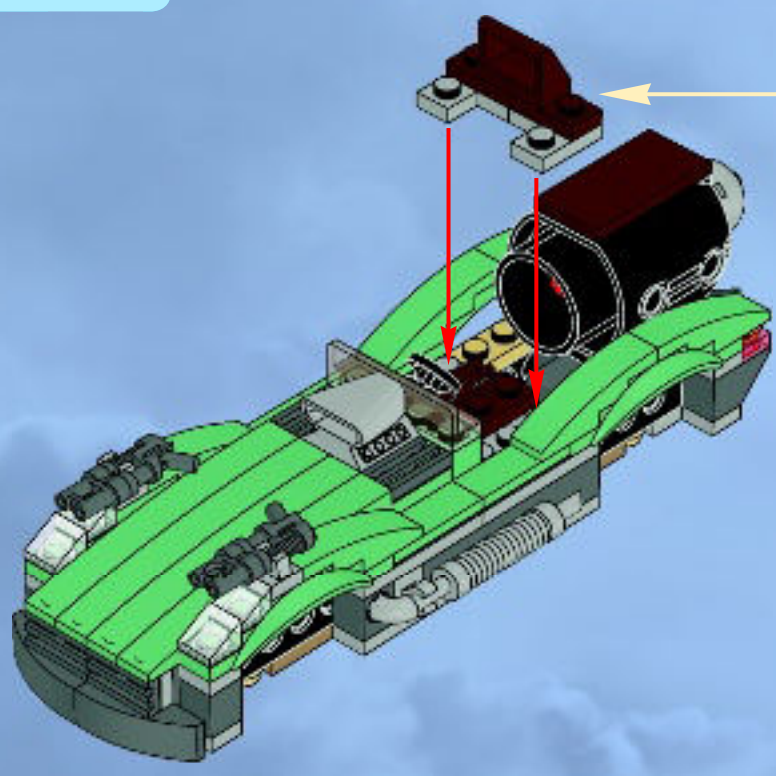

# 25

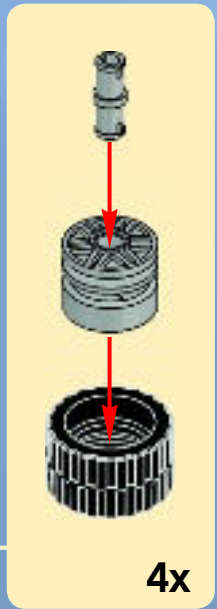
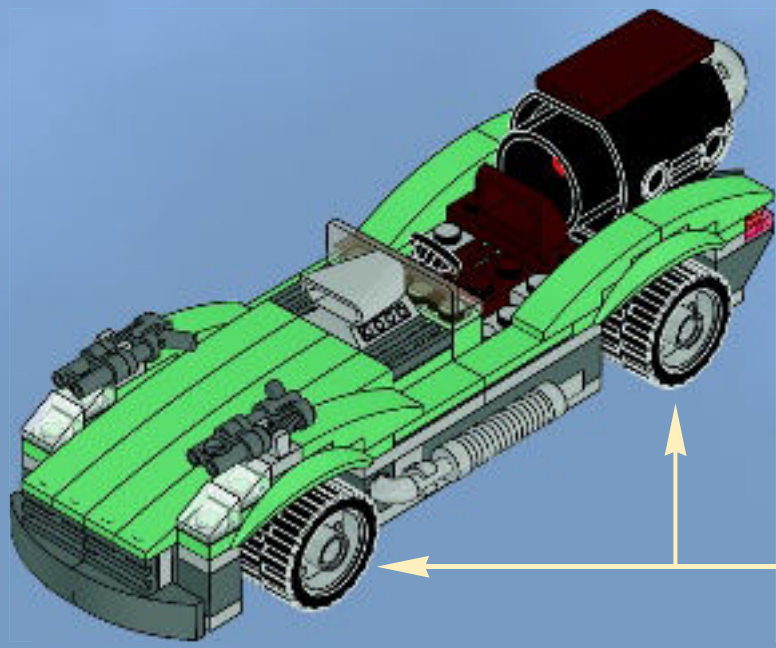



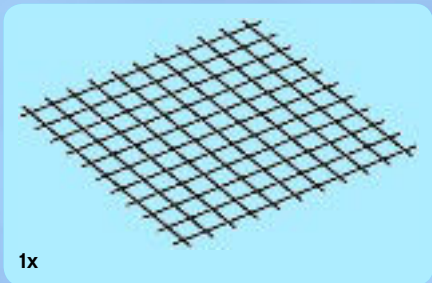

1x

# 26

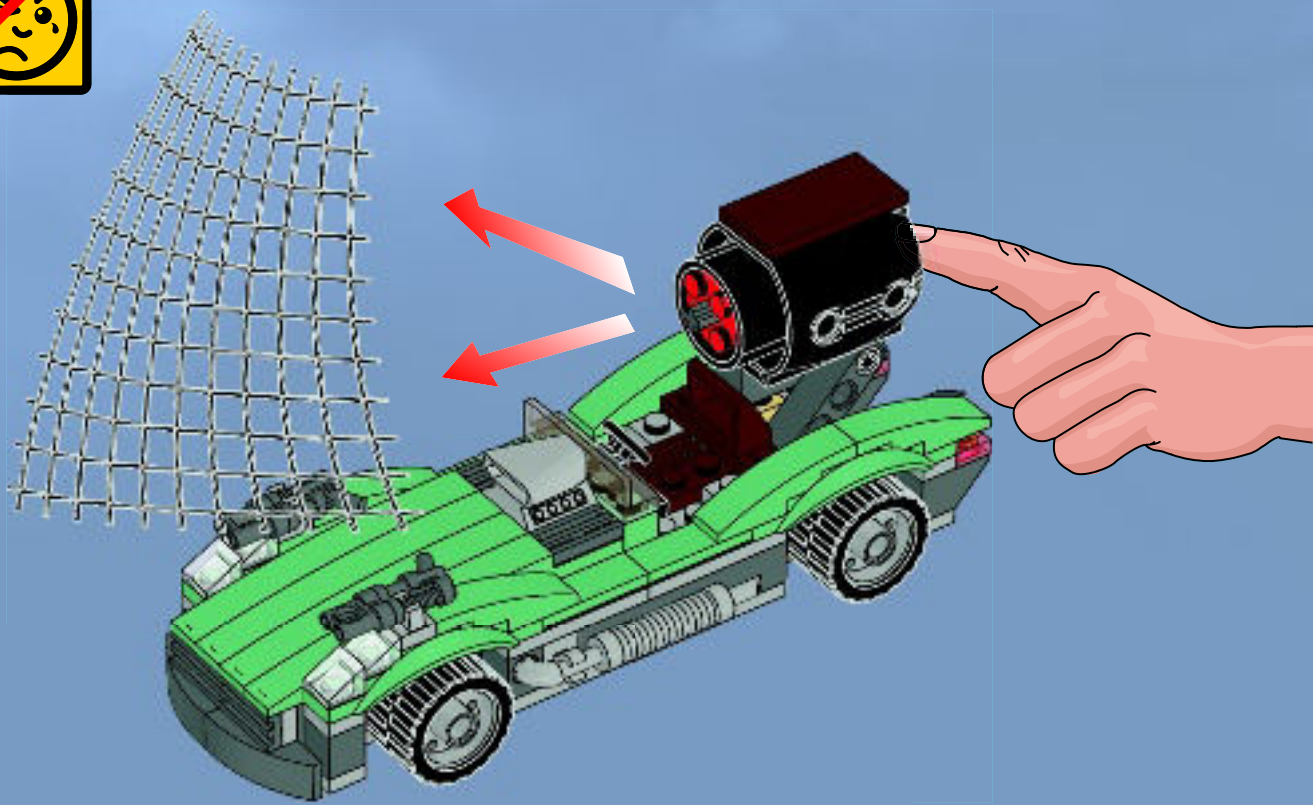
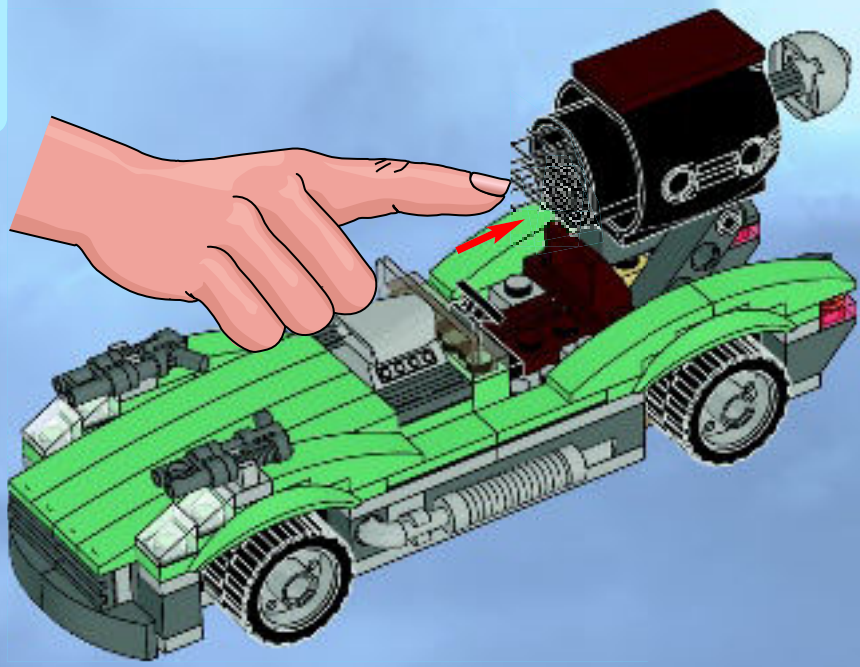



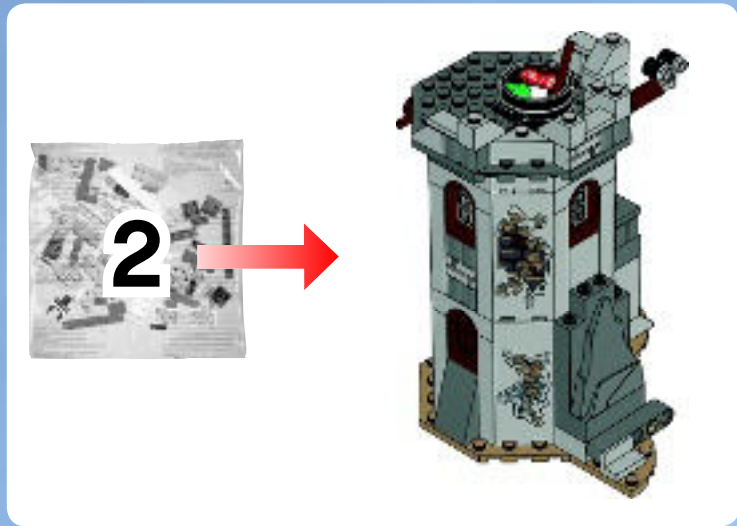

1

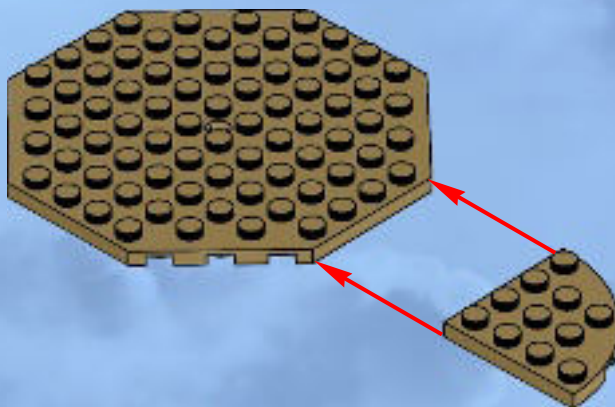

2

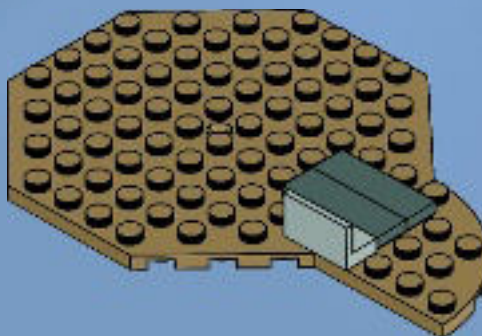



2x



1x

# 3

1

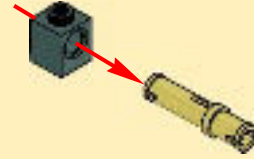

2

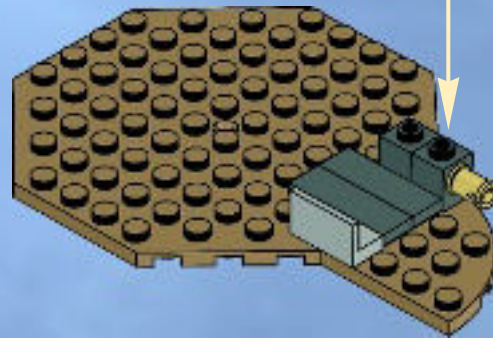
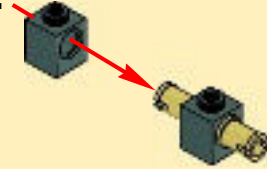

1x



1x

# 4

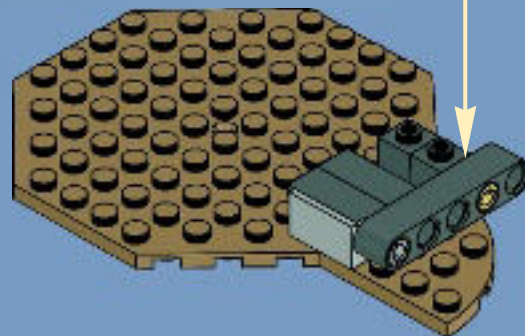
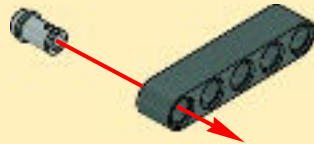



2x



1x

# 5

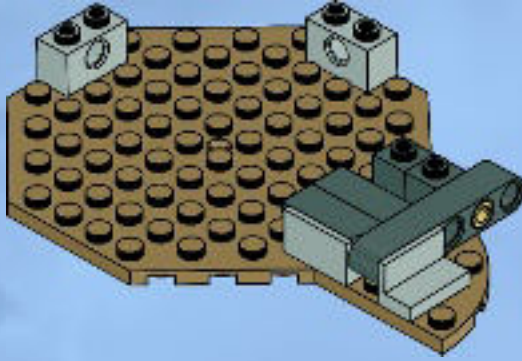

2x



1x



1x



1x

# 6

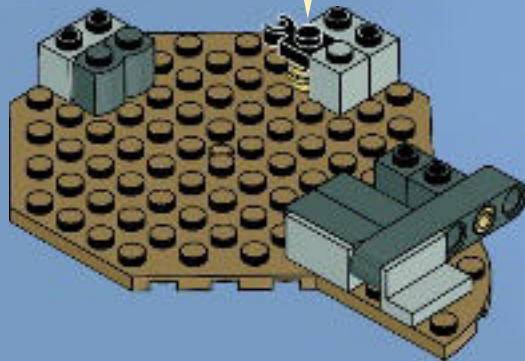





7

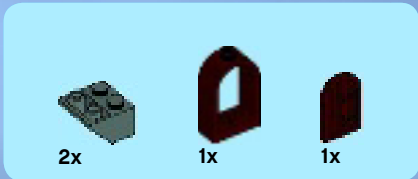
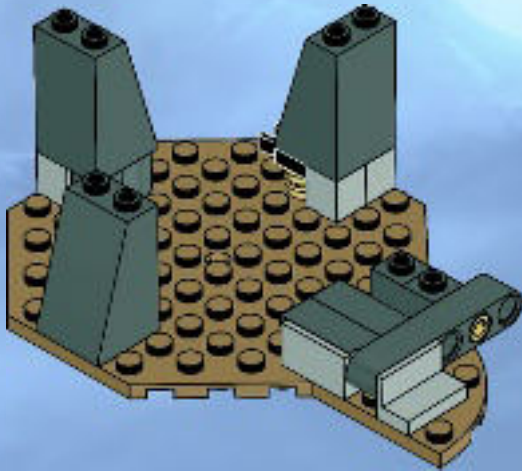

8

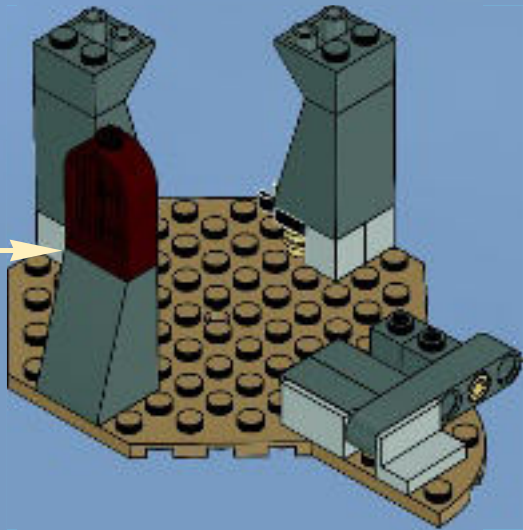
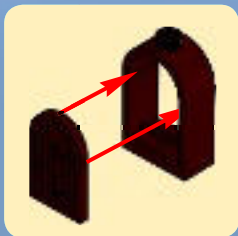



3x

# 9

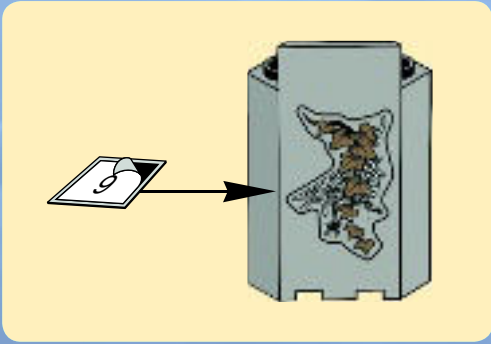
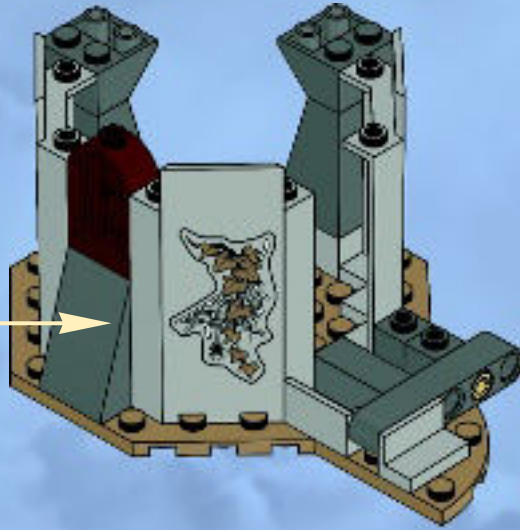

1x



1x



2x

# 10

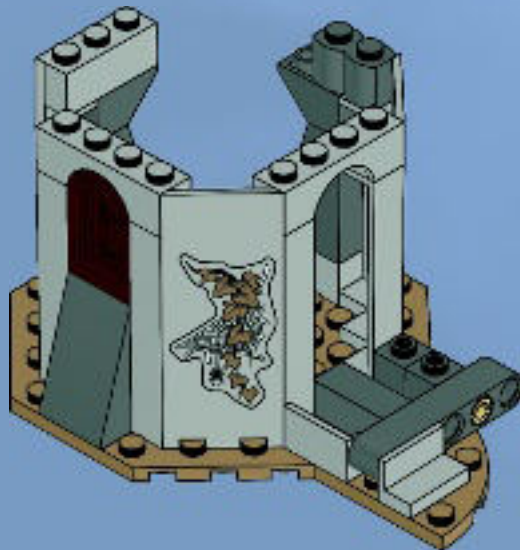



11

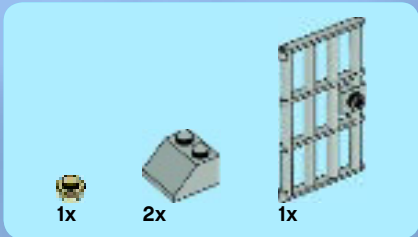
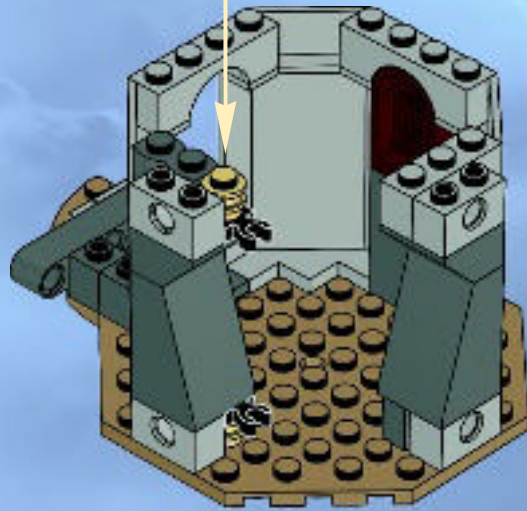

12

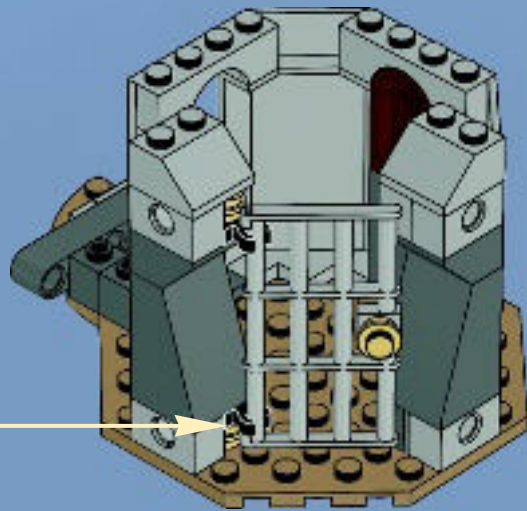
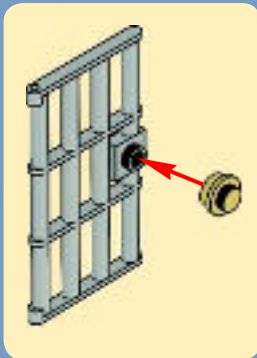



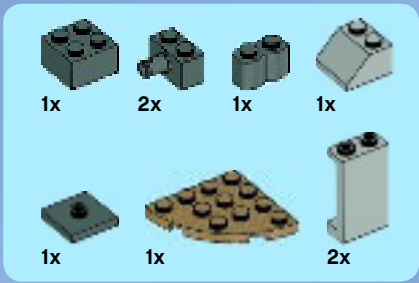

# 13

1



2



3

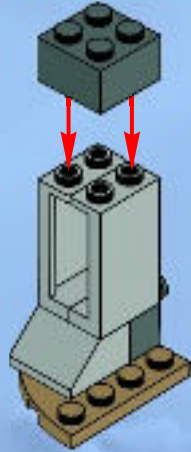

4

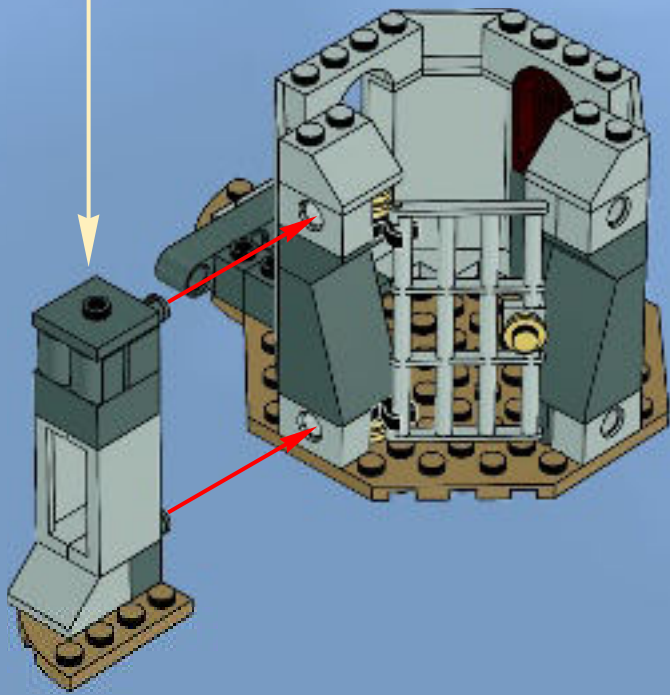
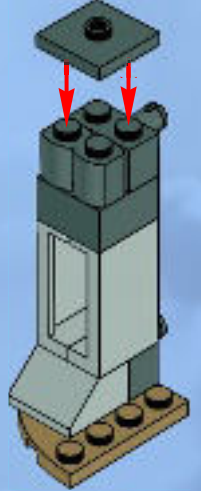



14

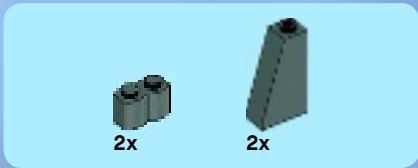
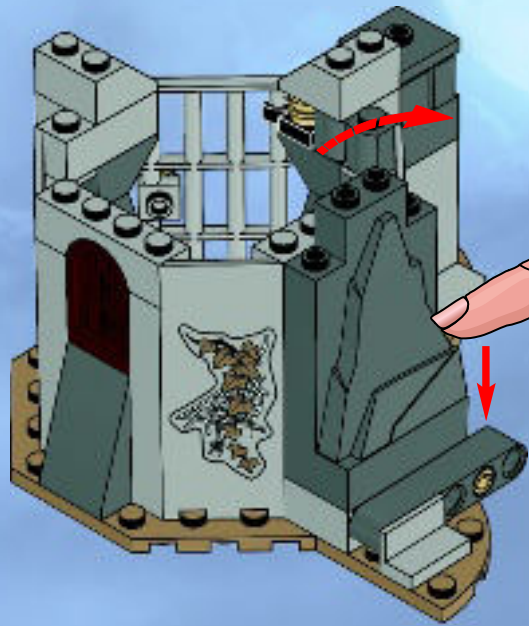

15

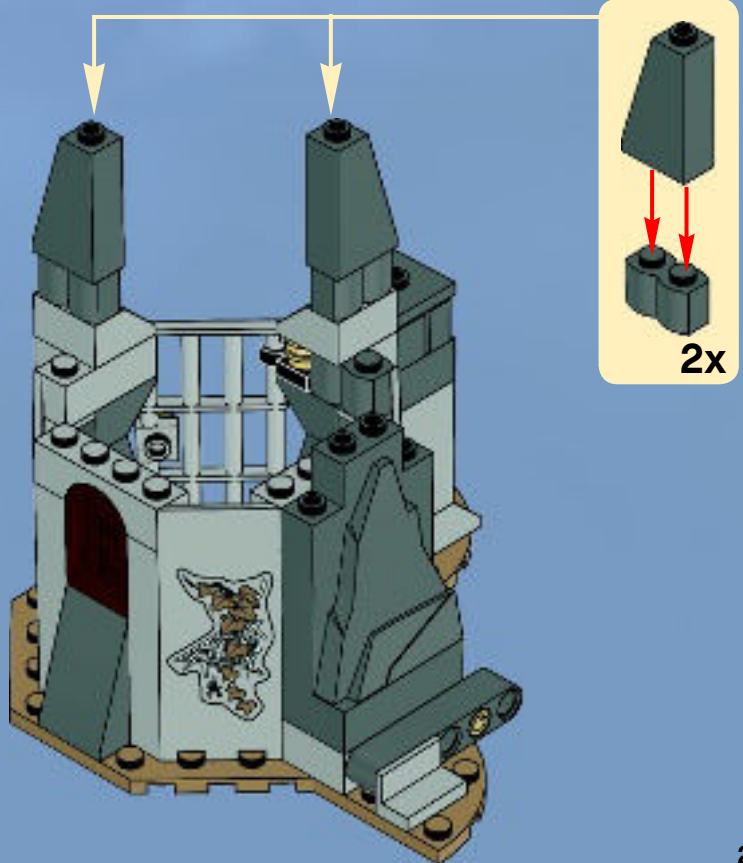



3x

# 16

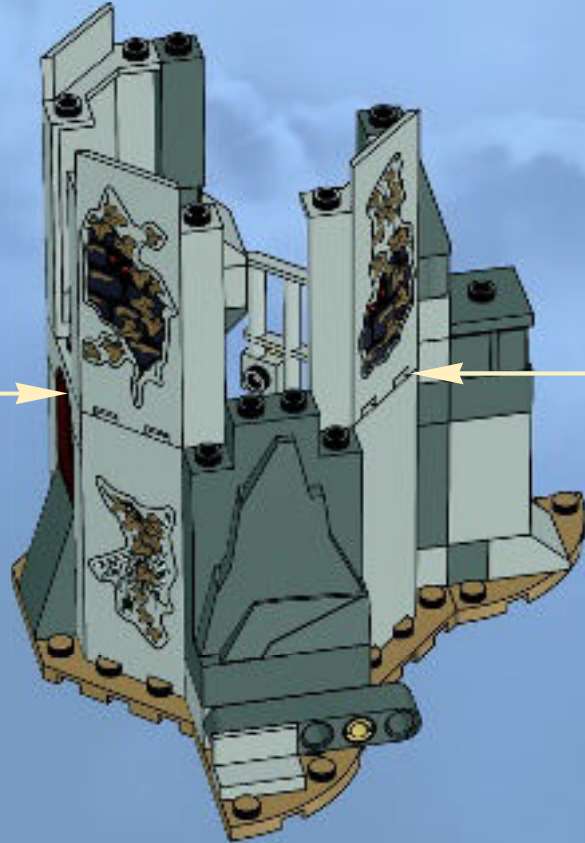
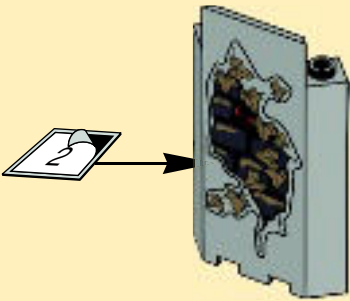
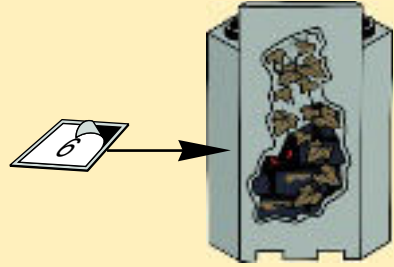



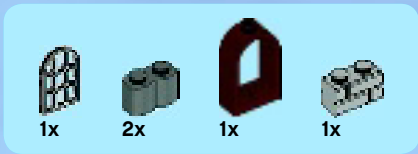

# 17

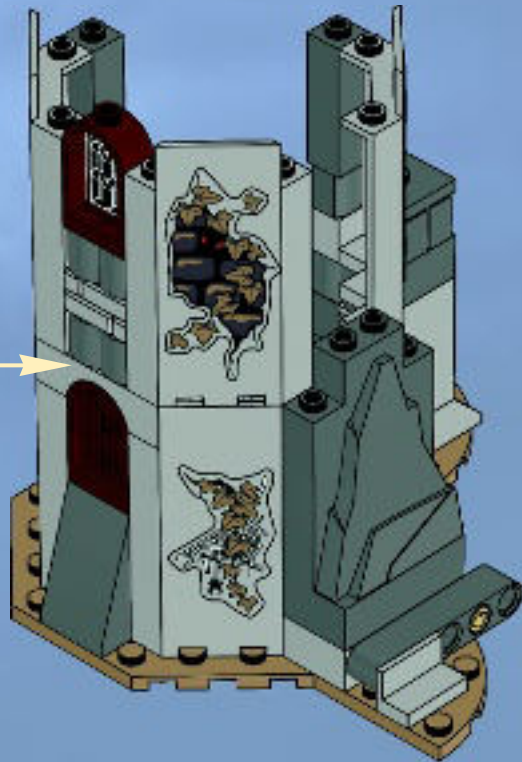
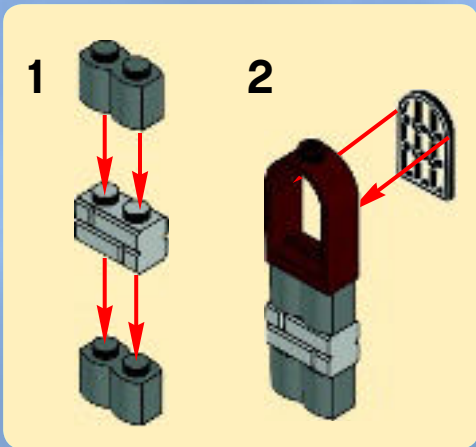

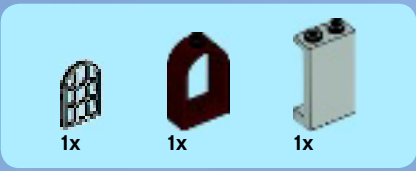

# 18

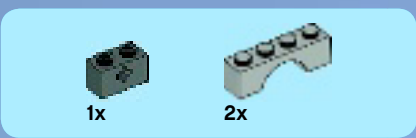
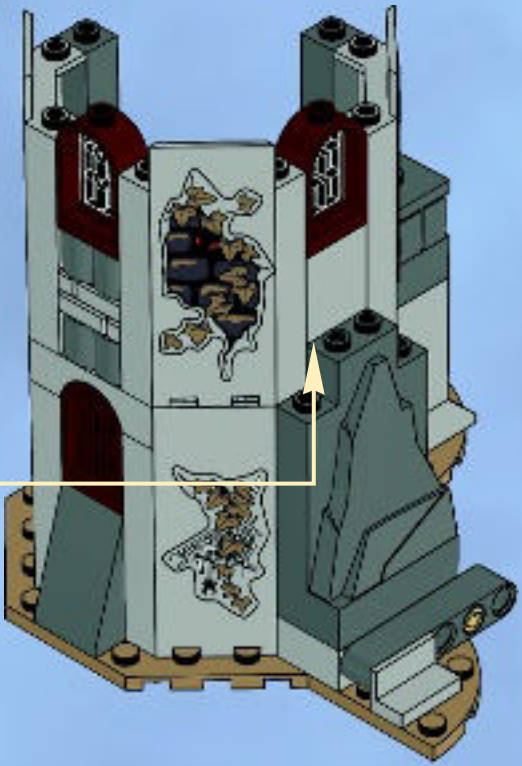
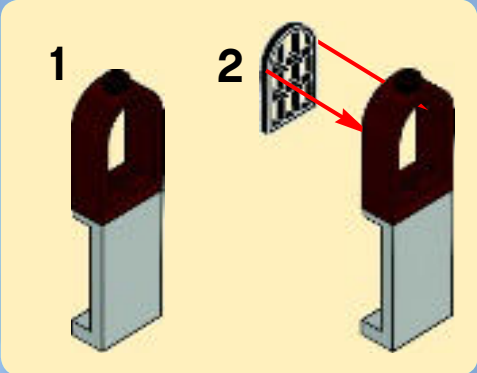

# 19





# 20

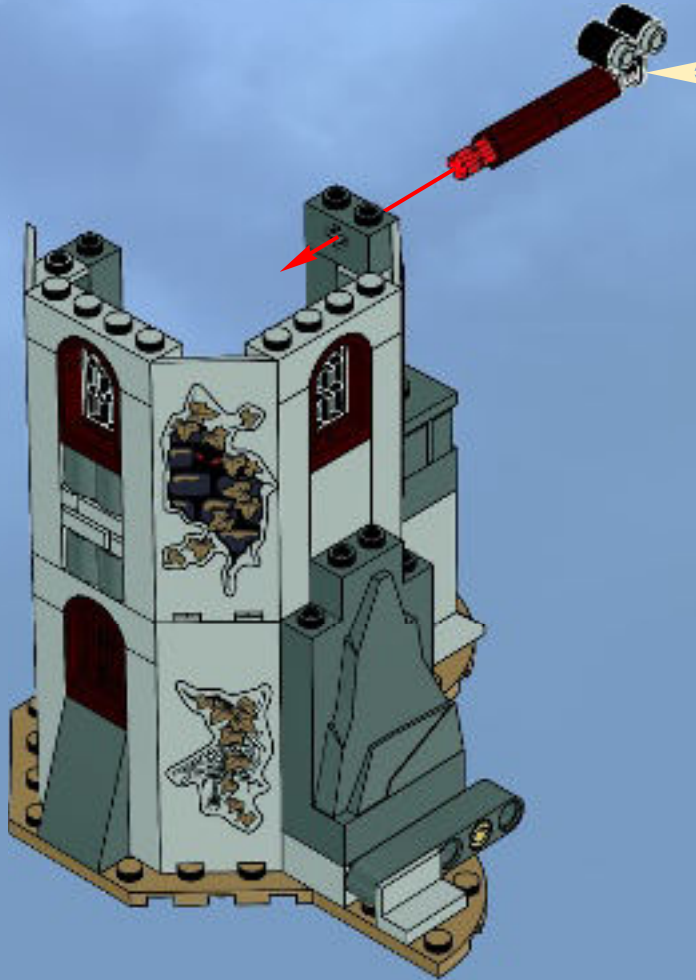
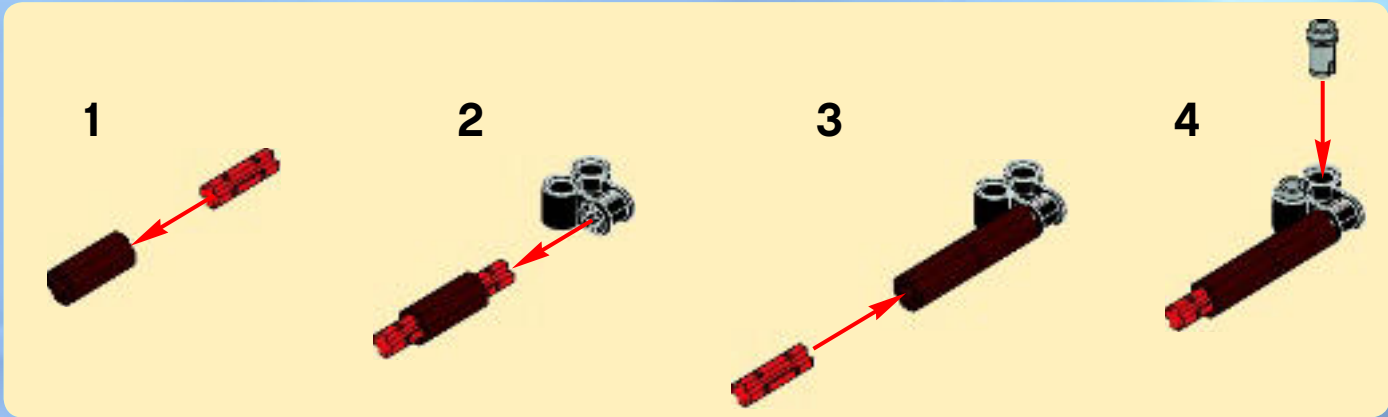





1

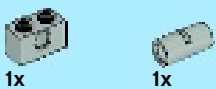

2

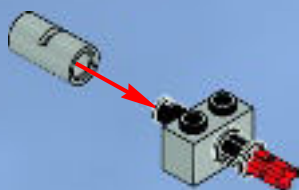

3

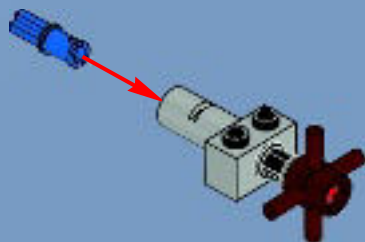

4

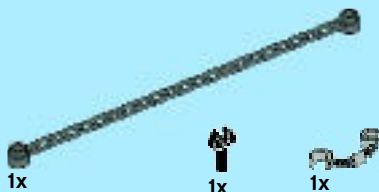
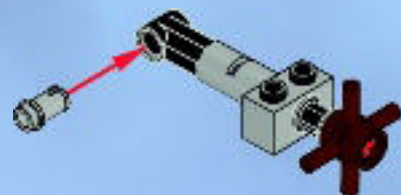

5

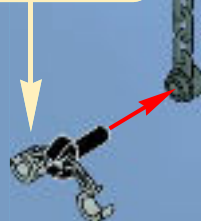
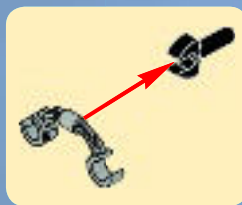

21

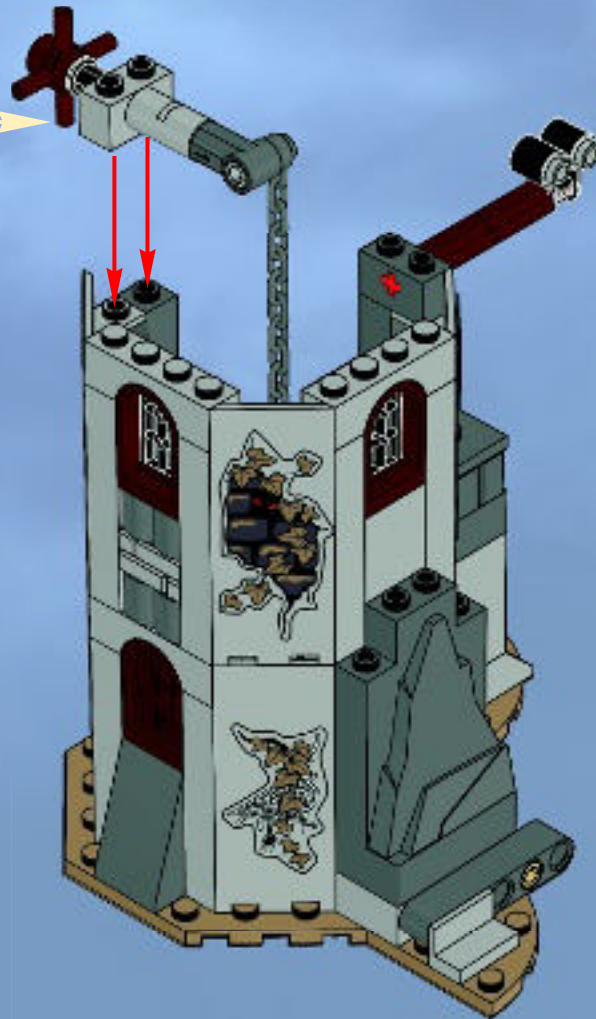



3x

# 22

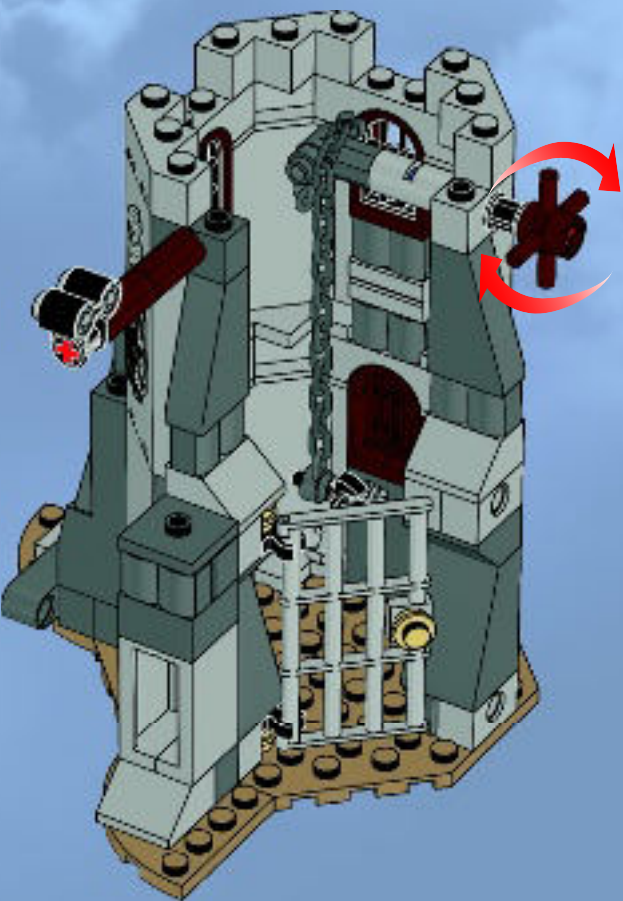

2x



2x

# 23





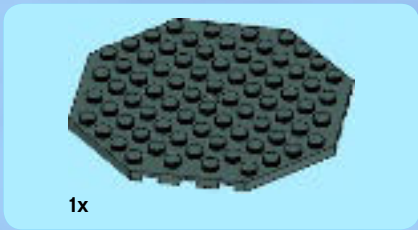

1x

# 24

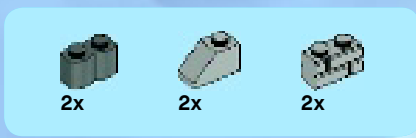

2x

2x

2x

# 25





2x

# 26



3x



4x

# 27





28





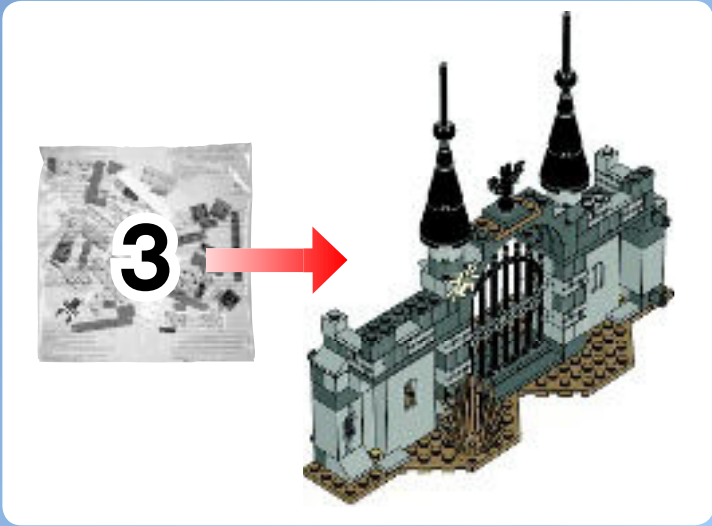

1

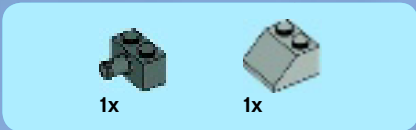
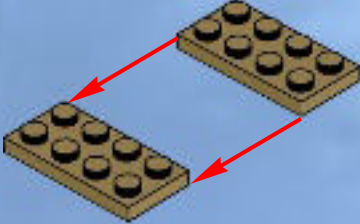

2

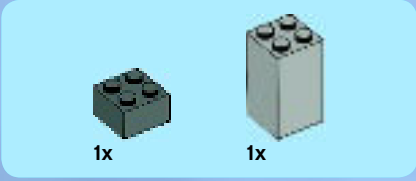
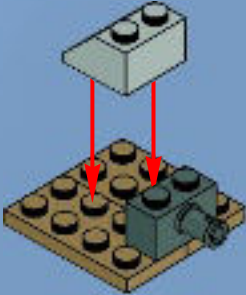

3

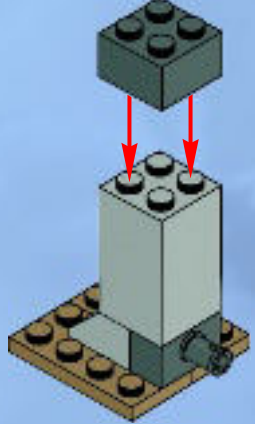

4

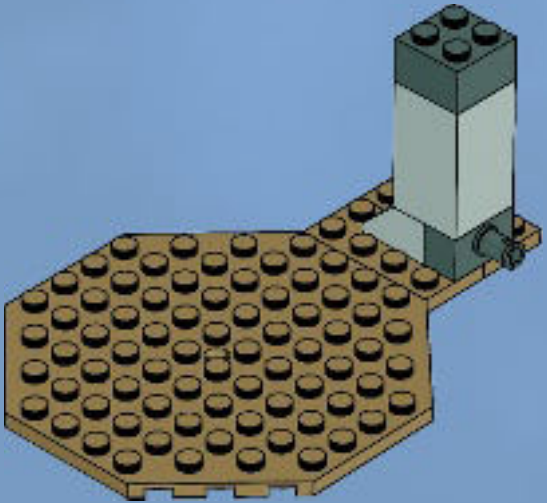



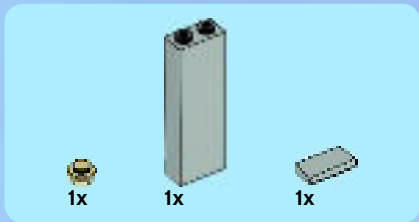

5

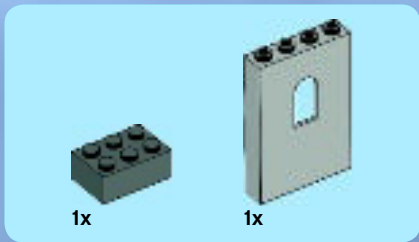
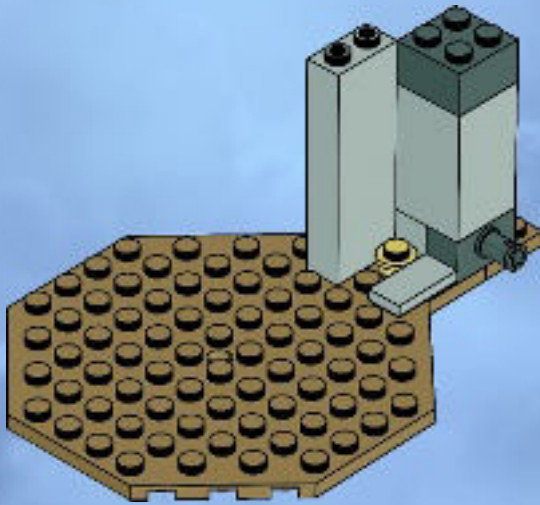

6

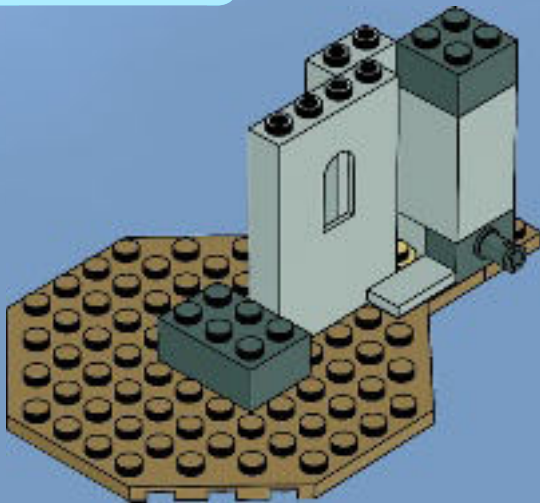

7

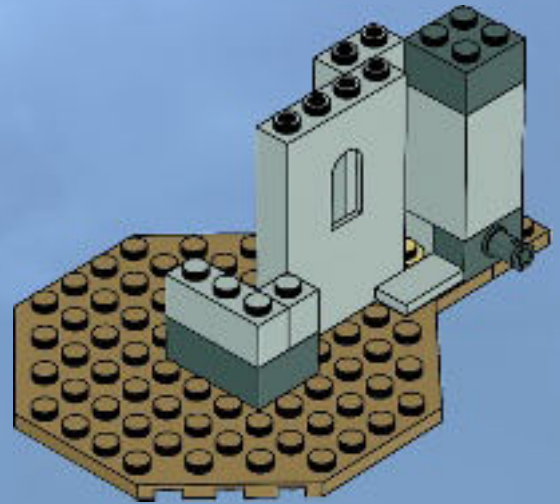



# 8

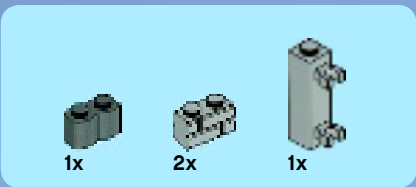
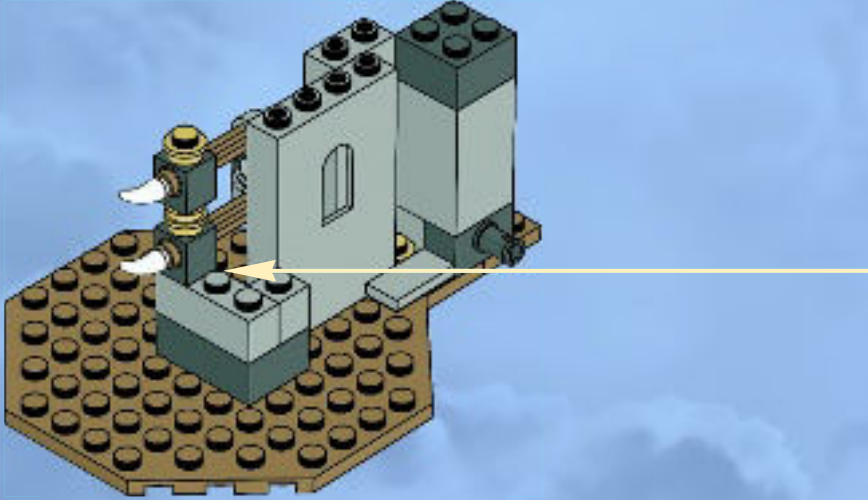
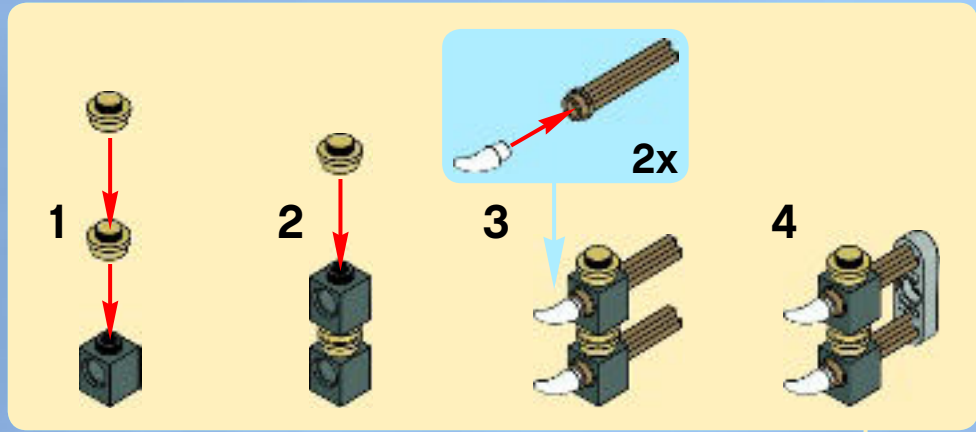

# 9

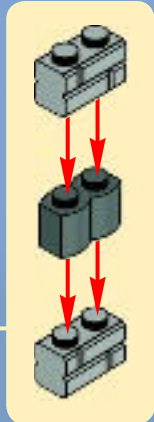
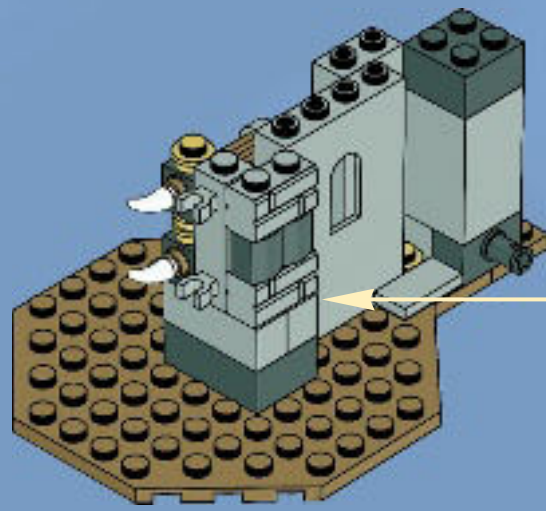

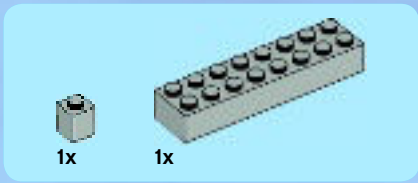

# 10

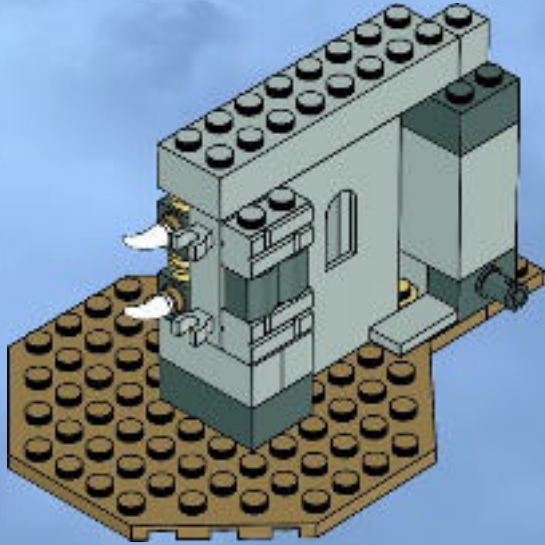

# 11

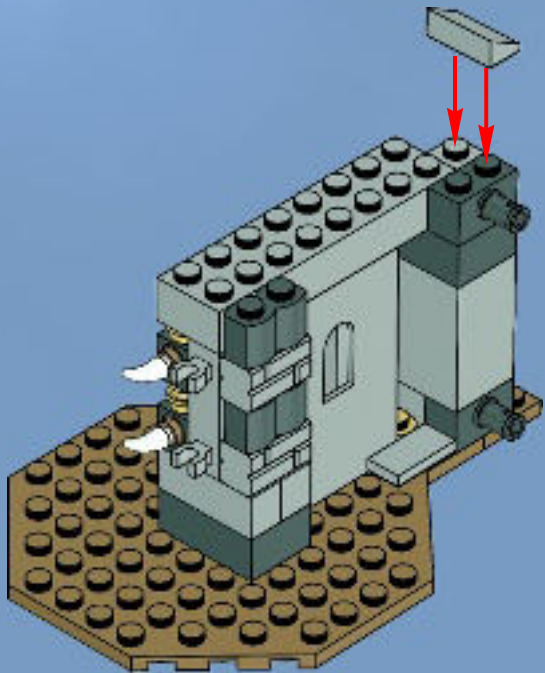



12

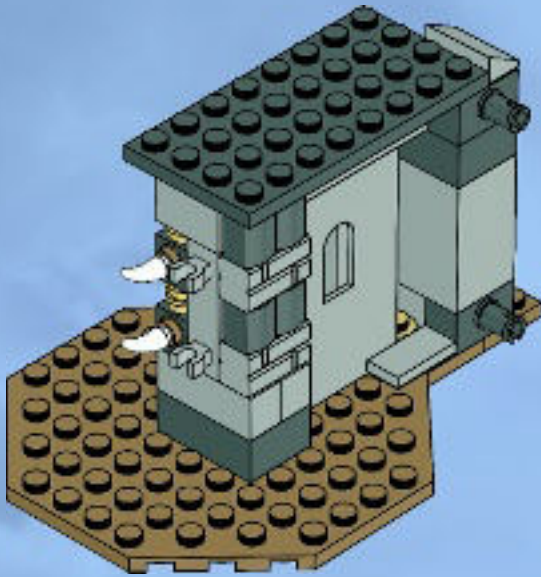

13

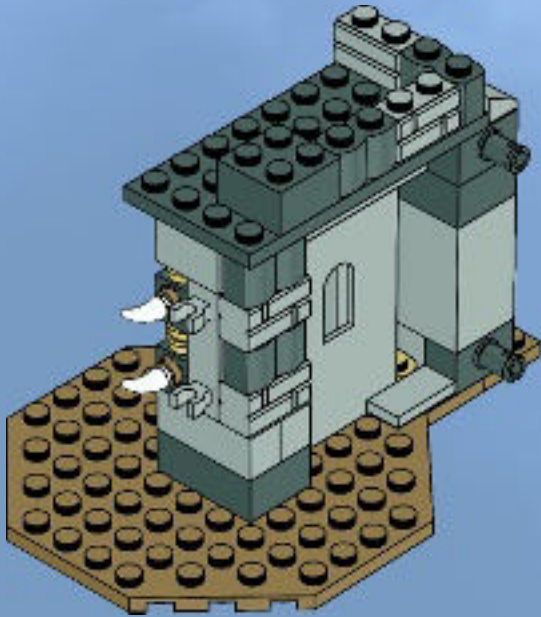





1x



1x



2x

# 14

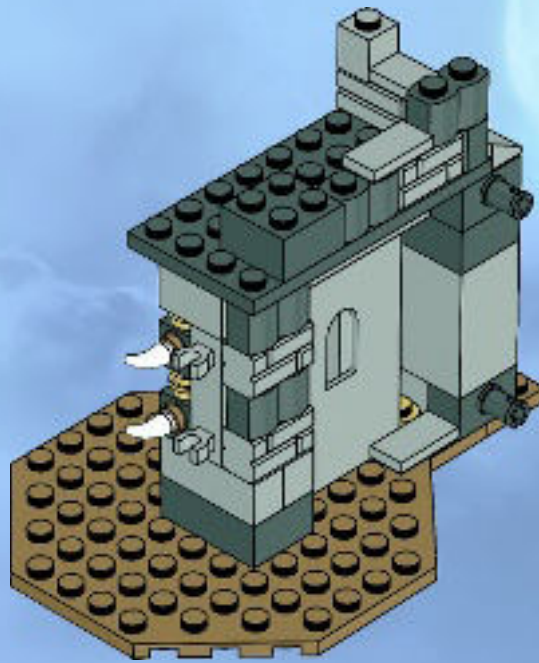

1x



1x



1x

# 15

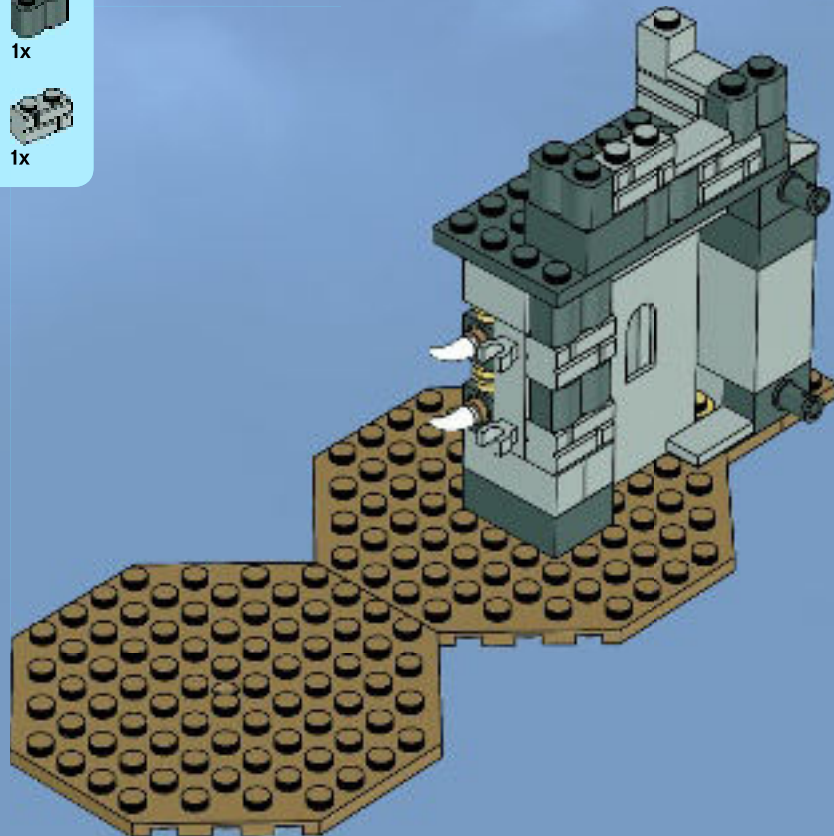

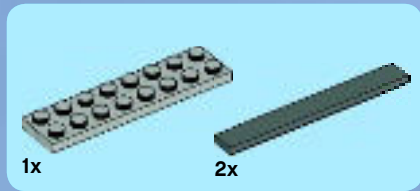

16

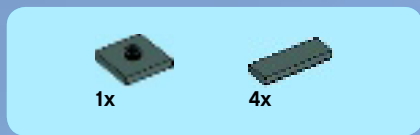
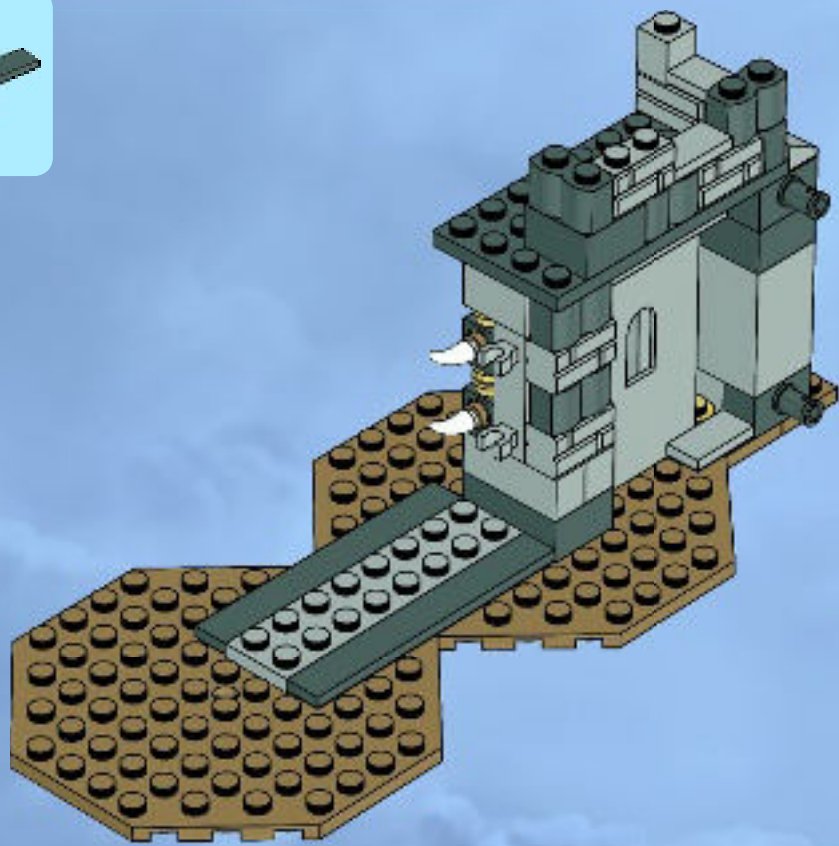

17

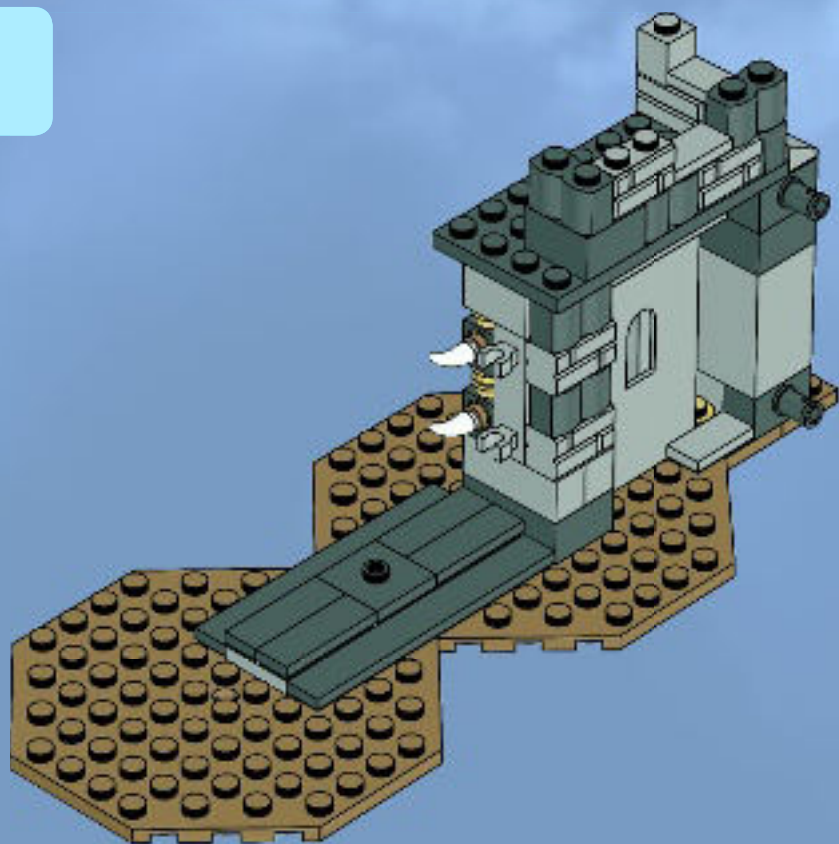



1x



1x



1x

# 18

1



2

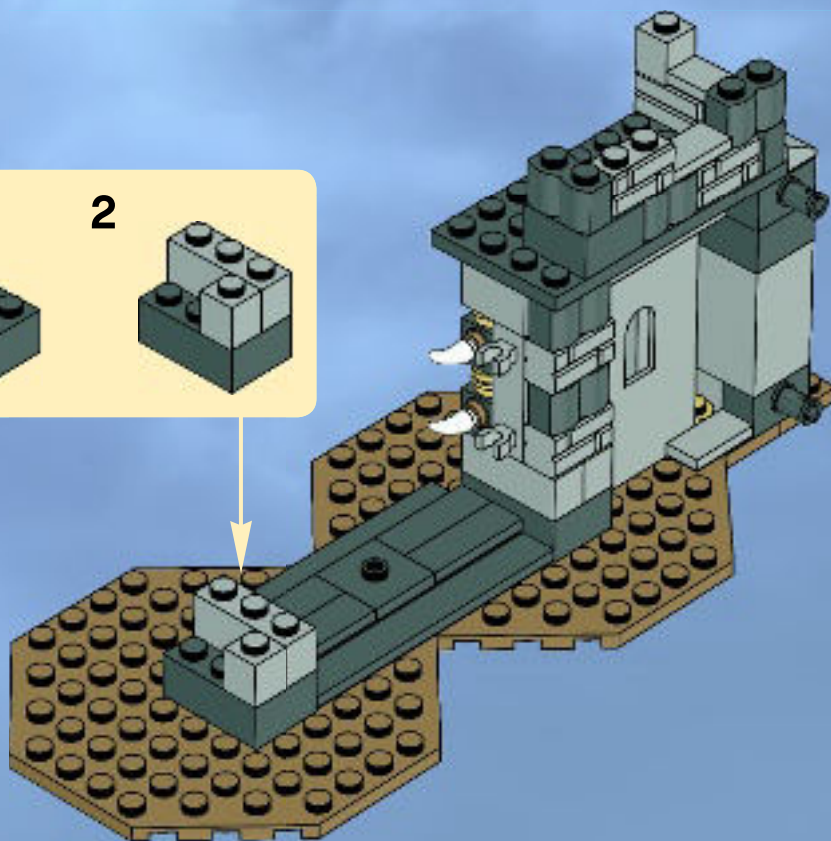
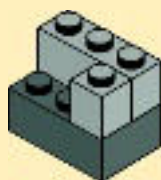





# 19

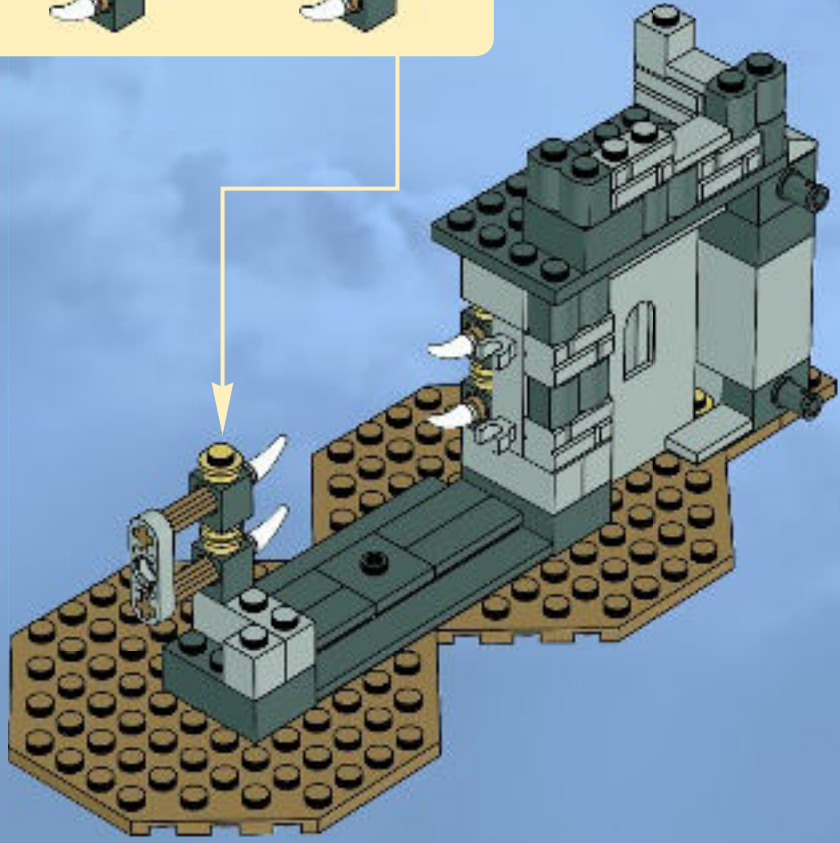
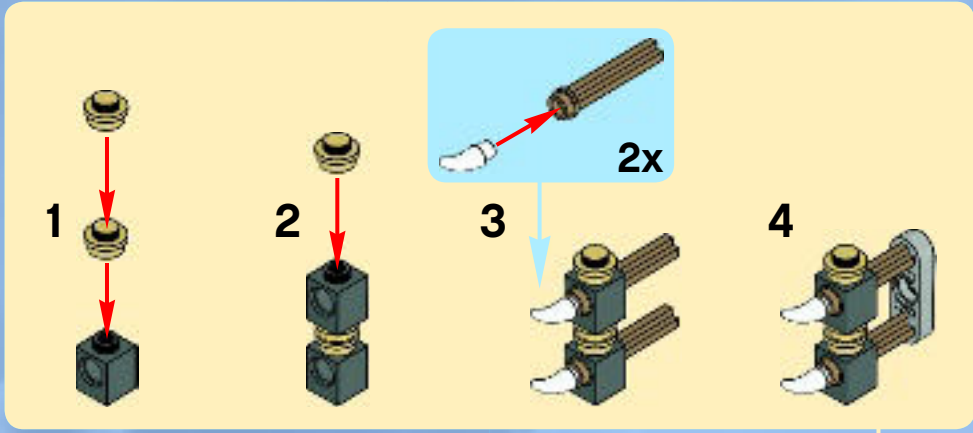





1x

# 20

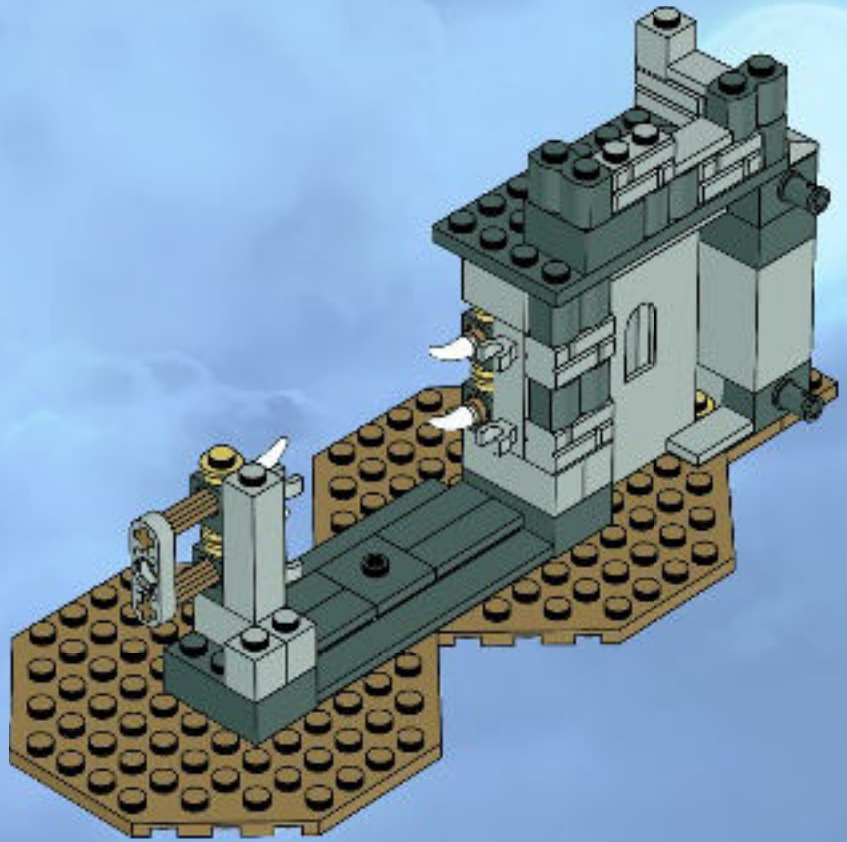

2x



2x

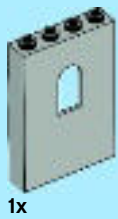

1x

# 21

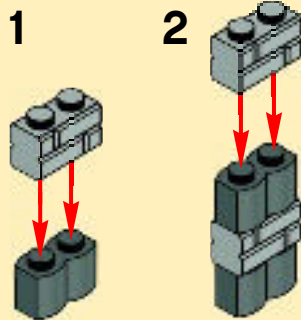

1

2

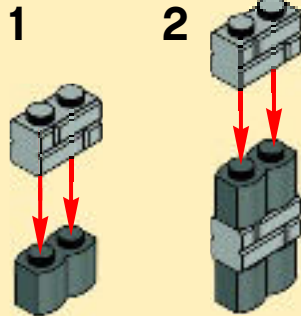

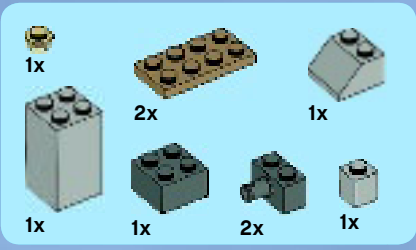

# 22

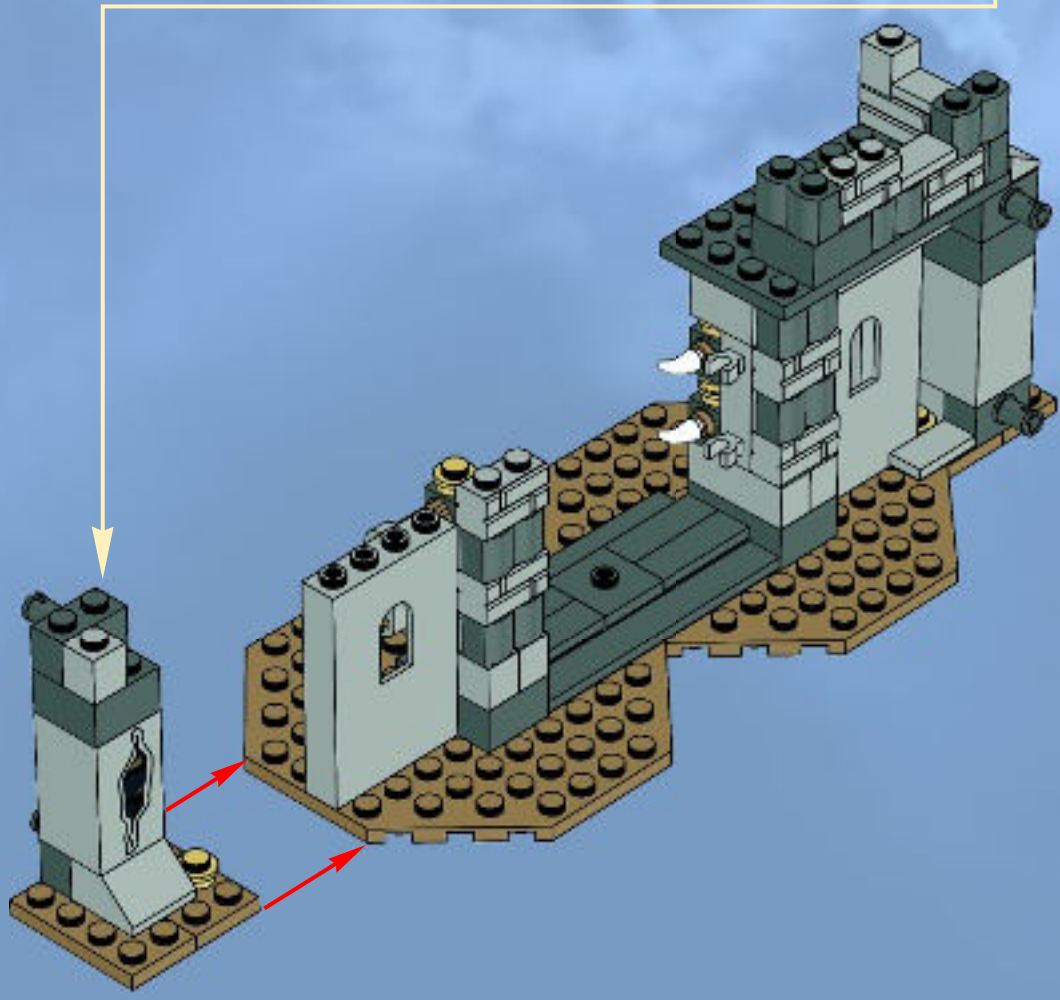
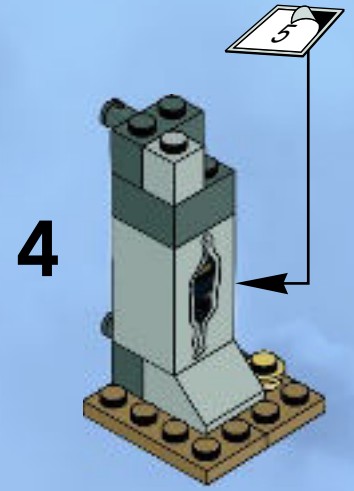
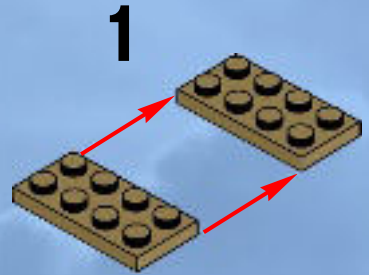

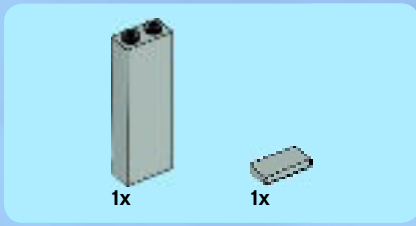

23

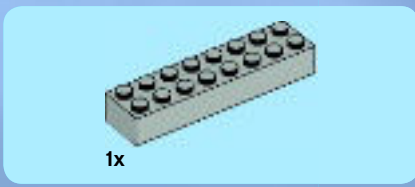
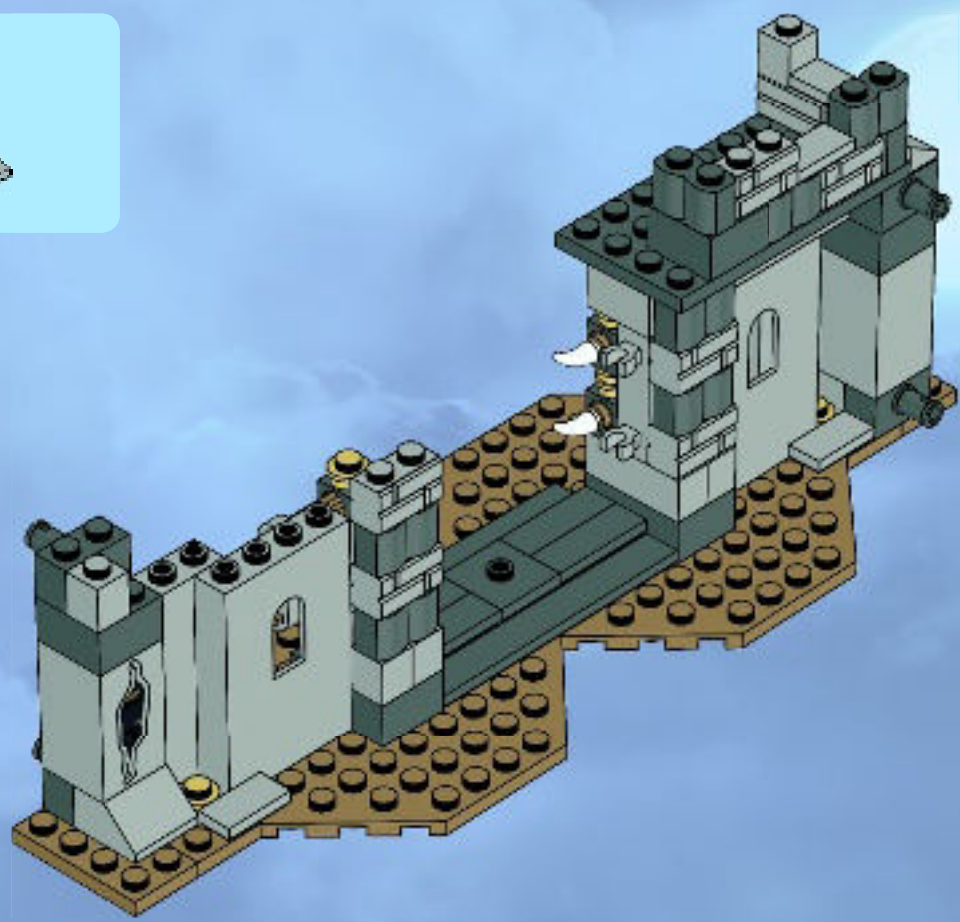

24

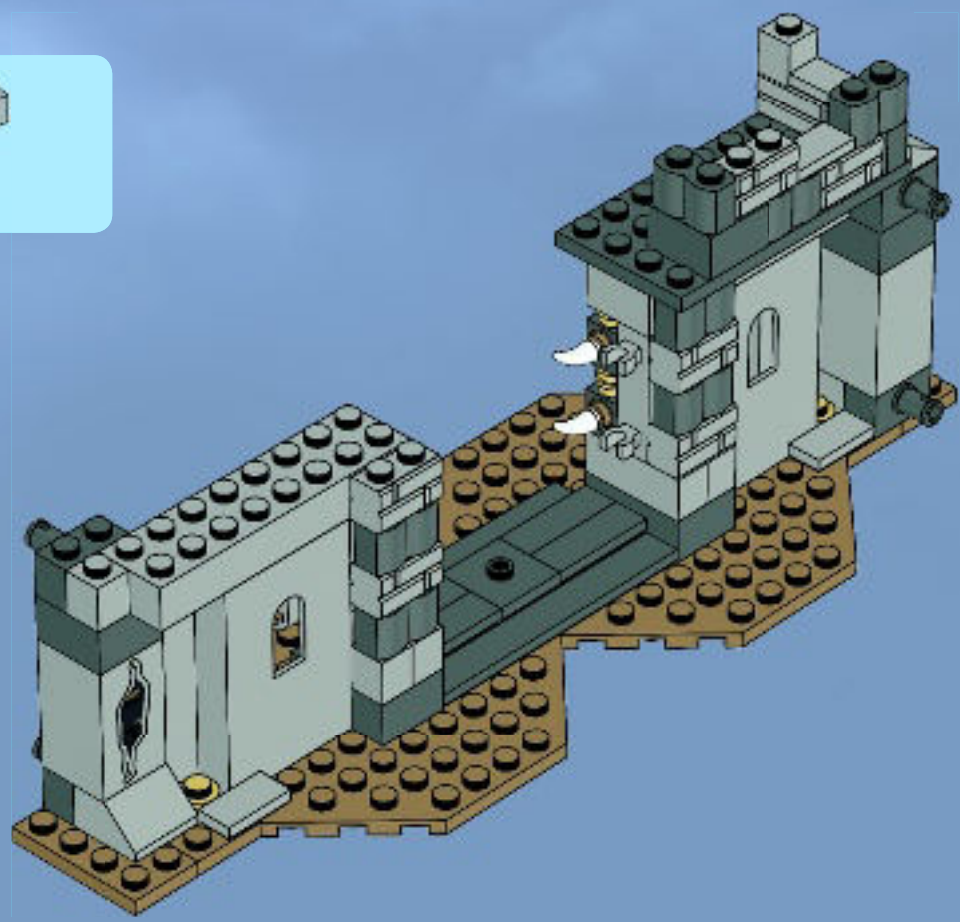





# 25

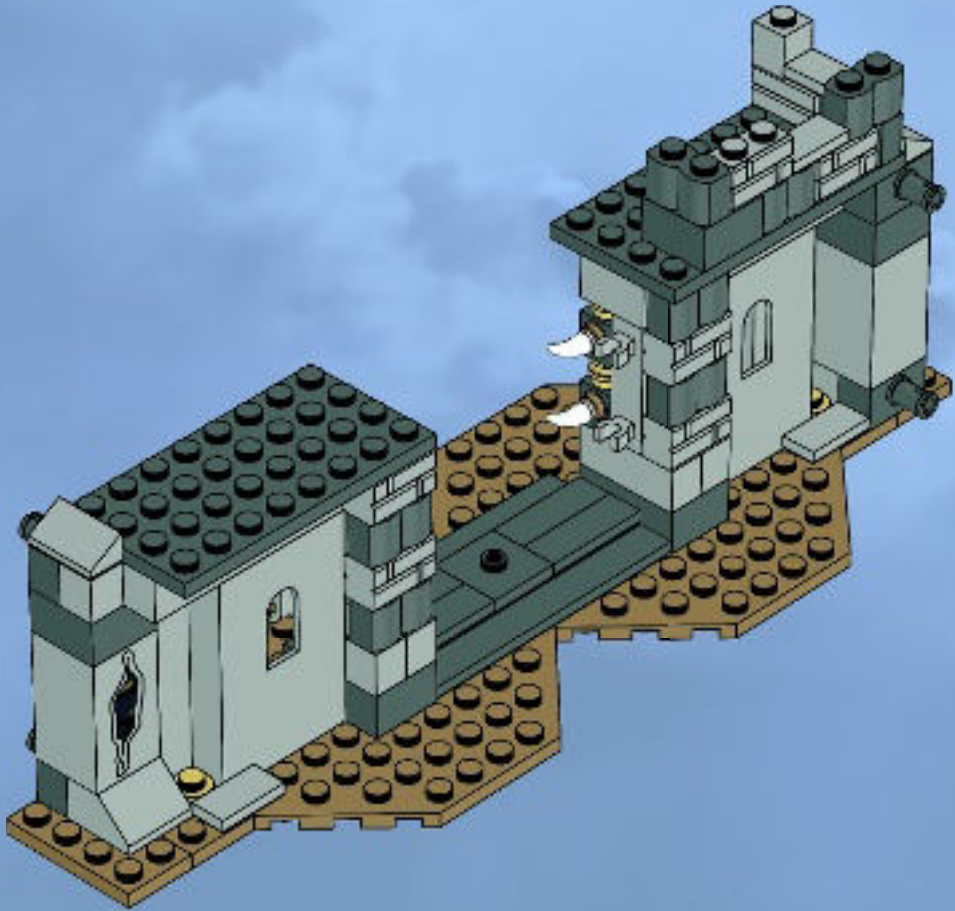





1x



2x



2x

# 26

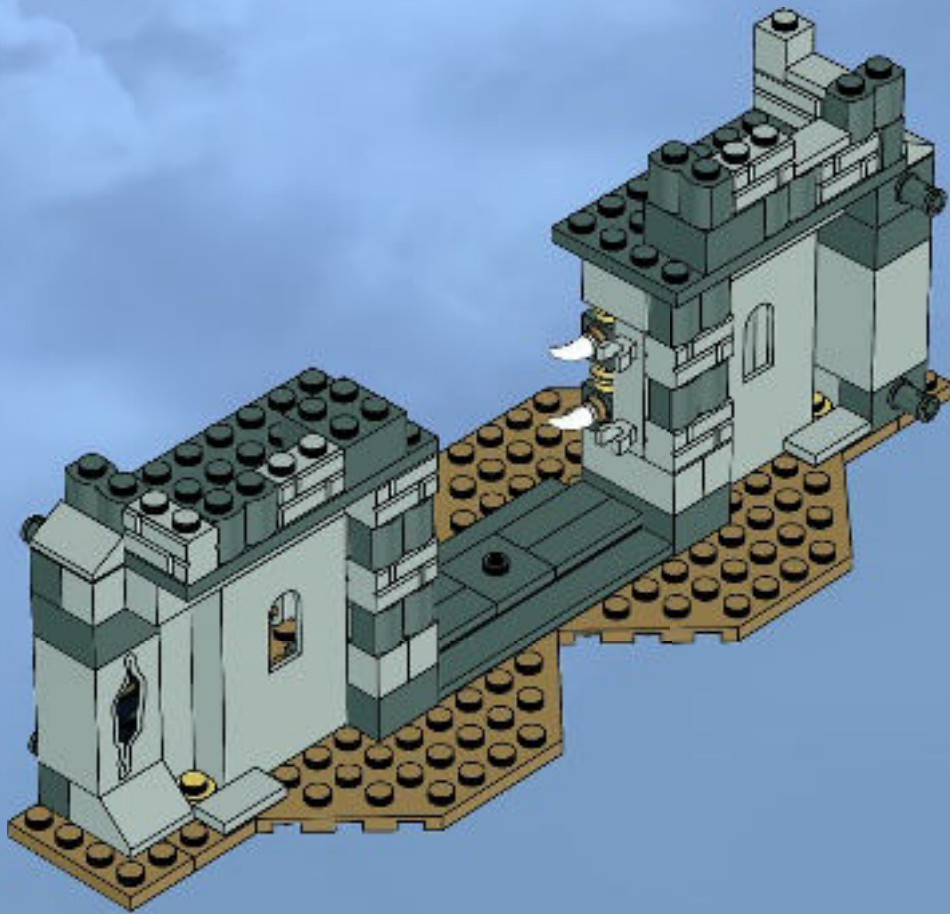



3x



1x



2x

# 27

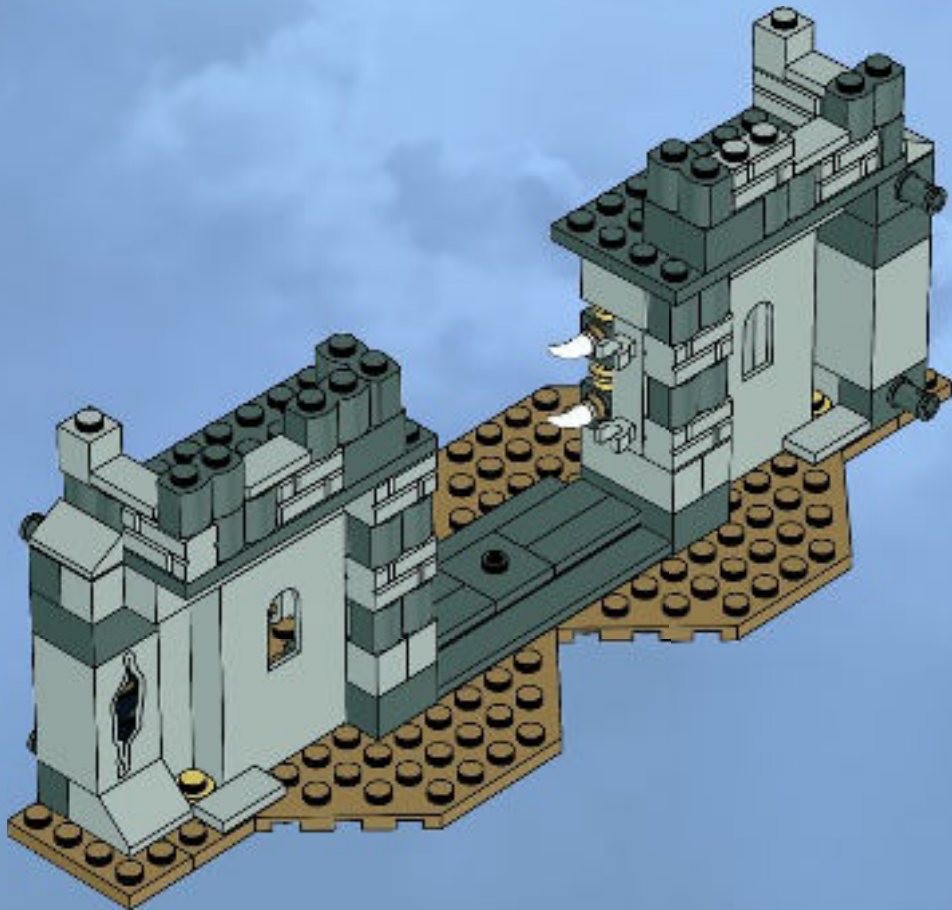

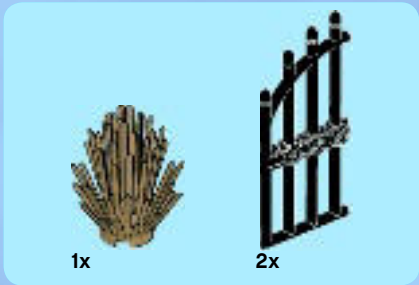

# 28

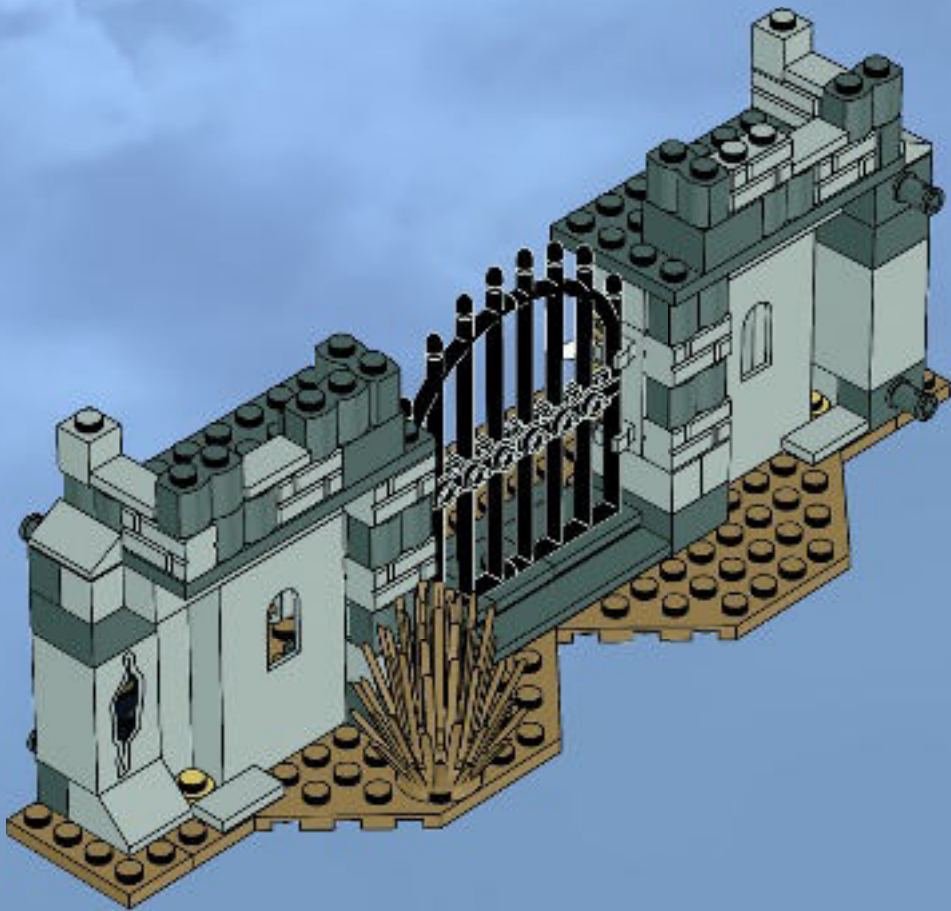

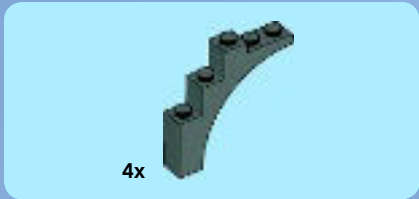

29

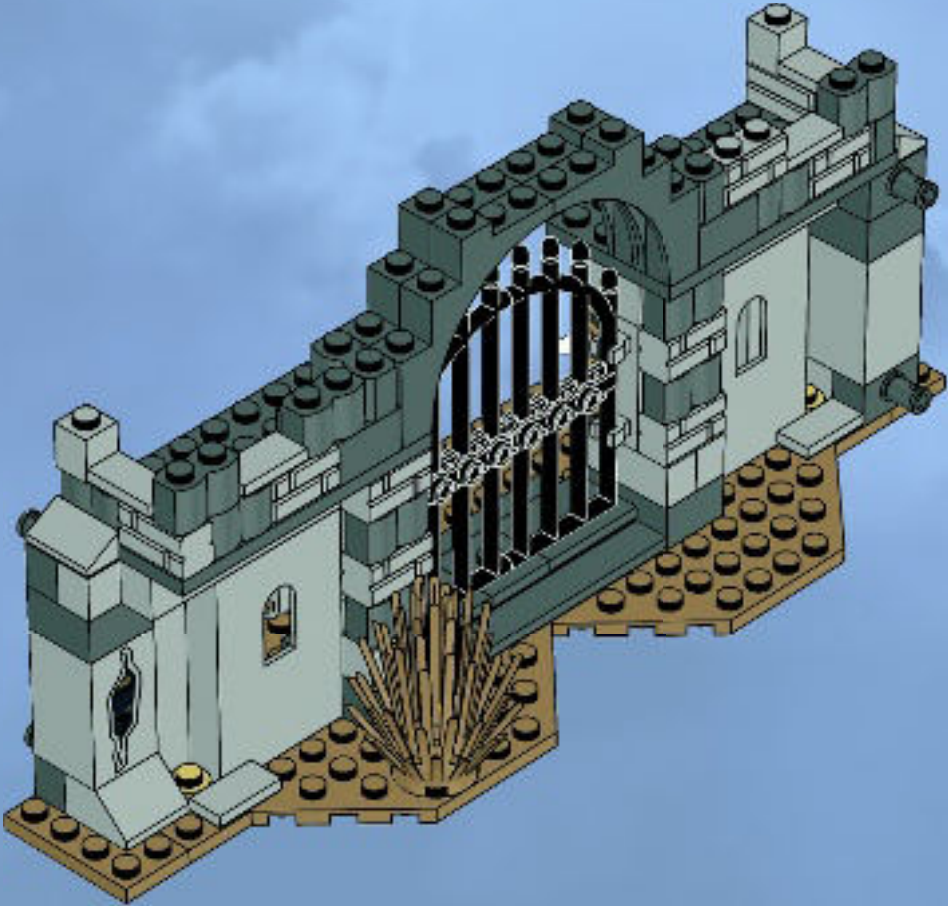





1x



2x

# 30

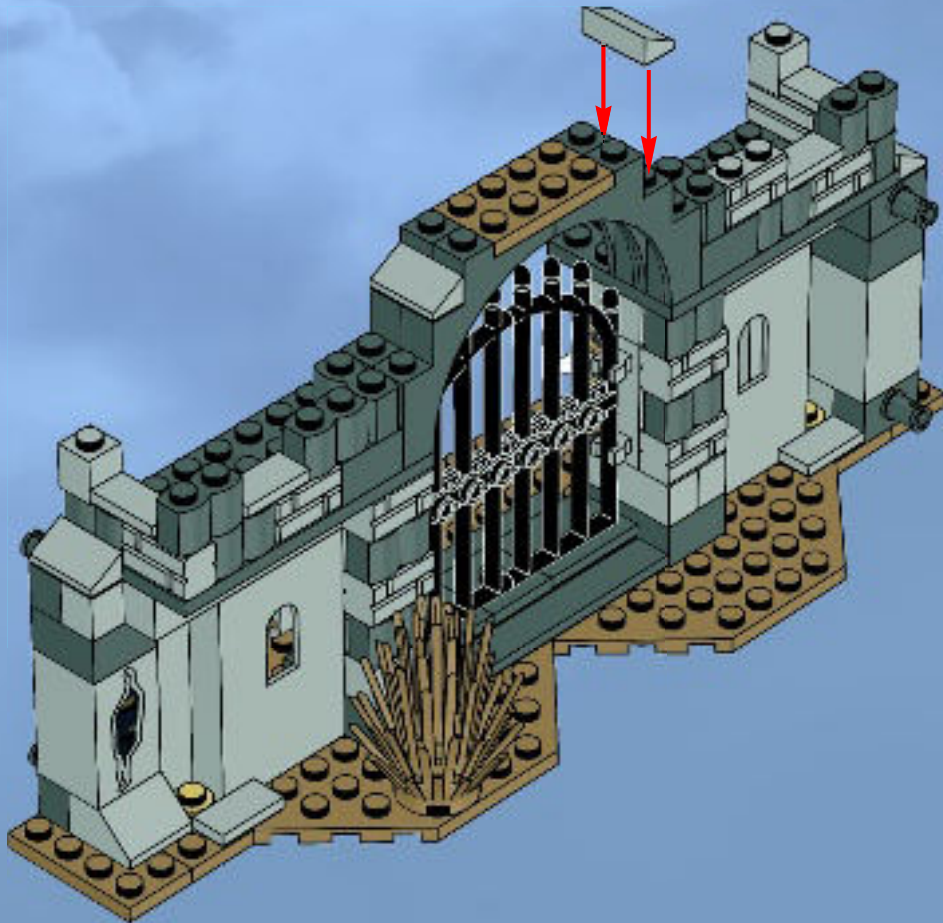



2x

# 31

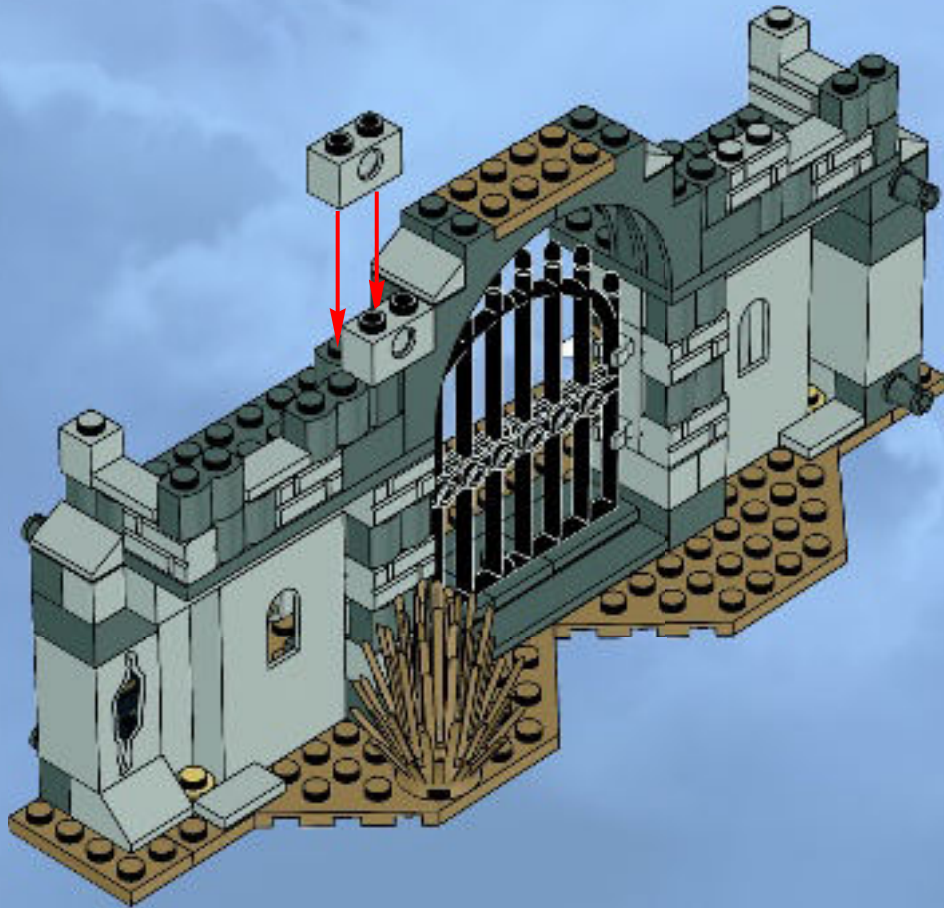



1x



1x

1

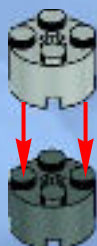

1x



1x

2

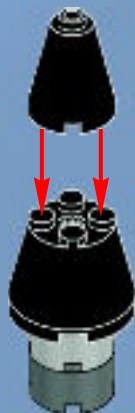

1x



1x

3



1x

4



2x

32

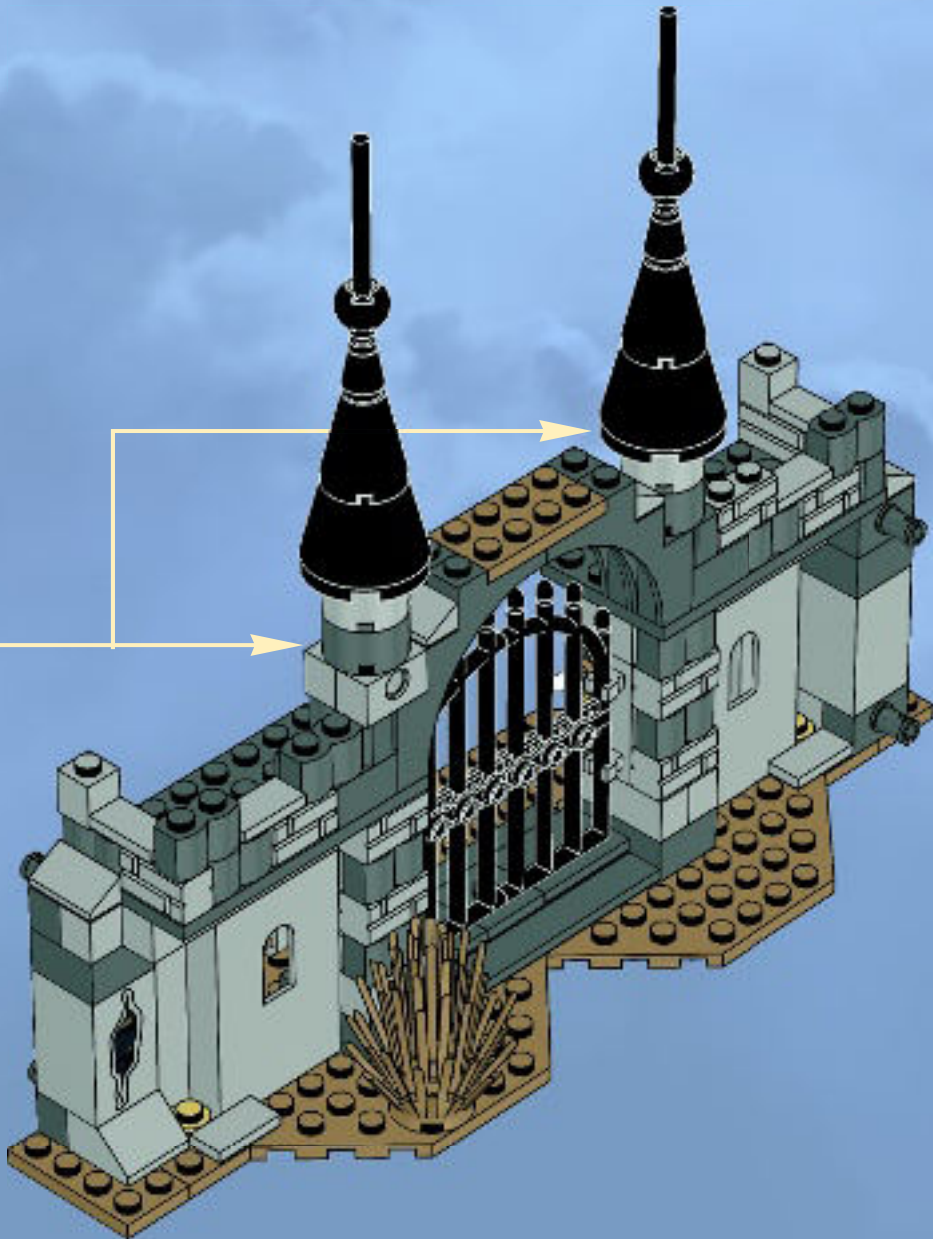





1x





1x

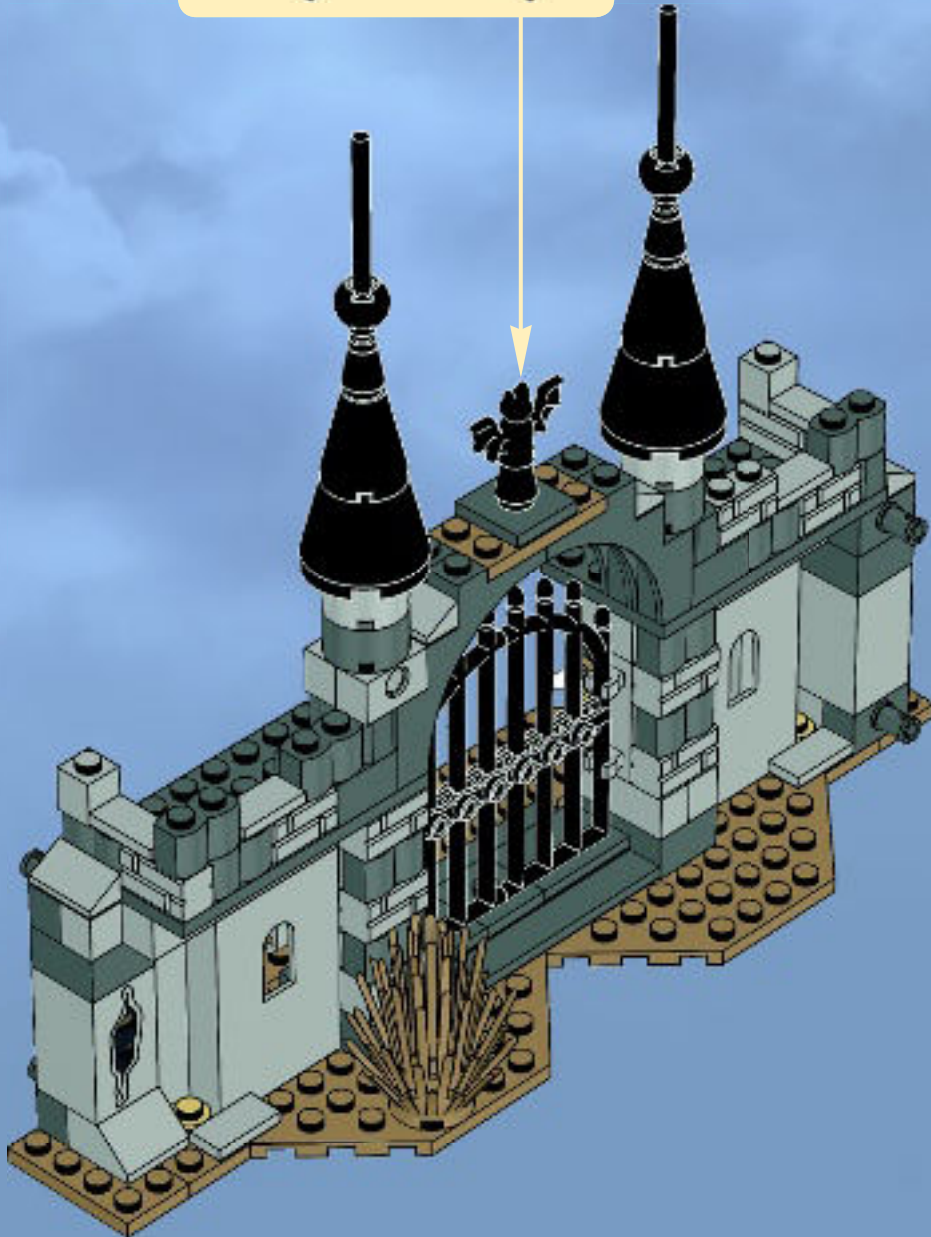
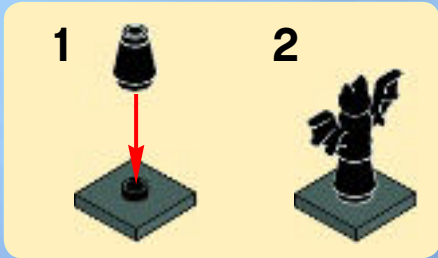

1x

# 33



- 1x 
- 1x 

# 34

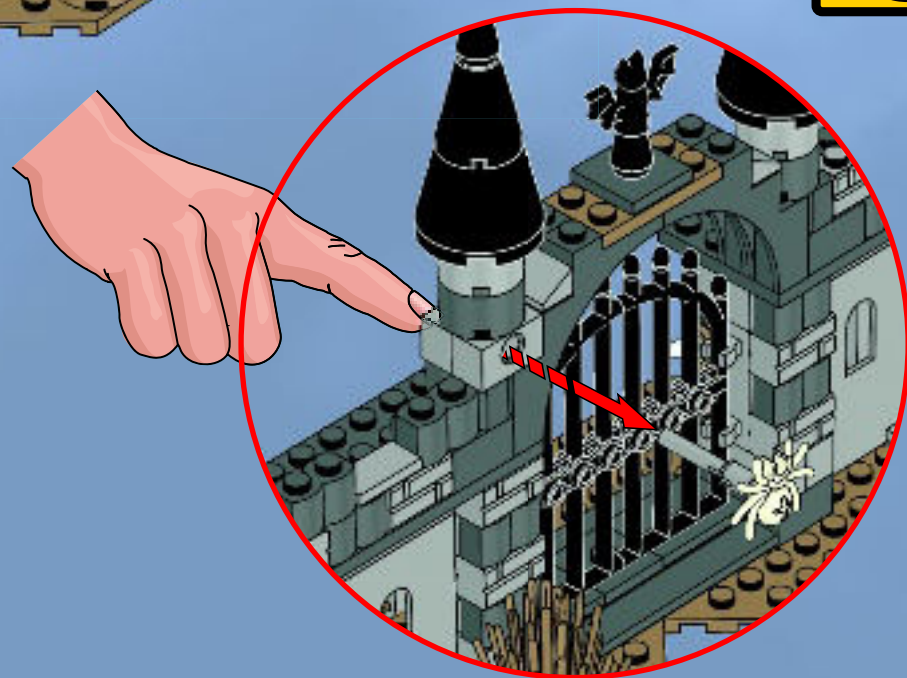
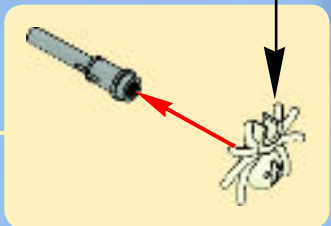
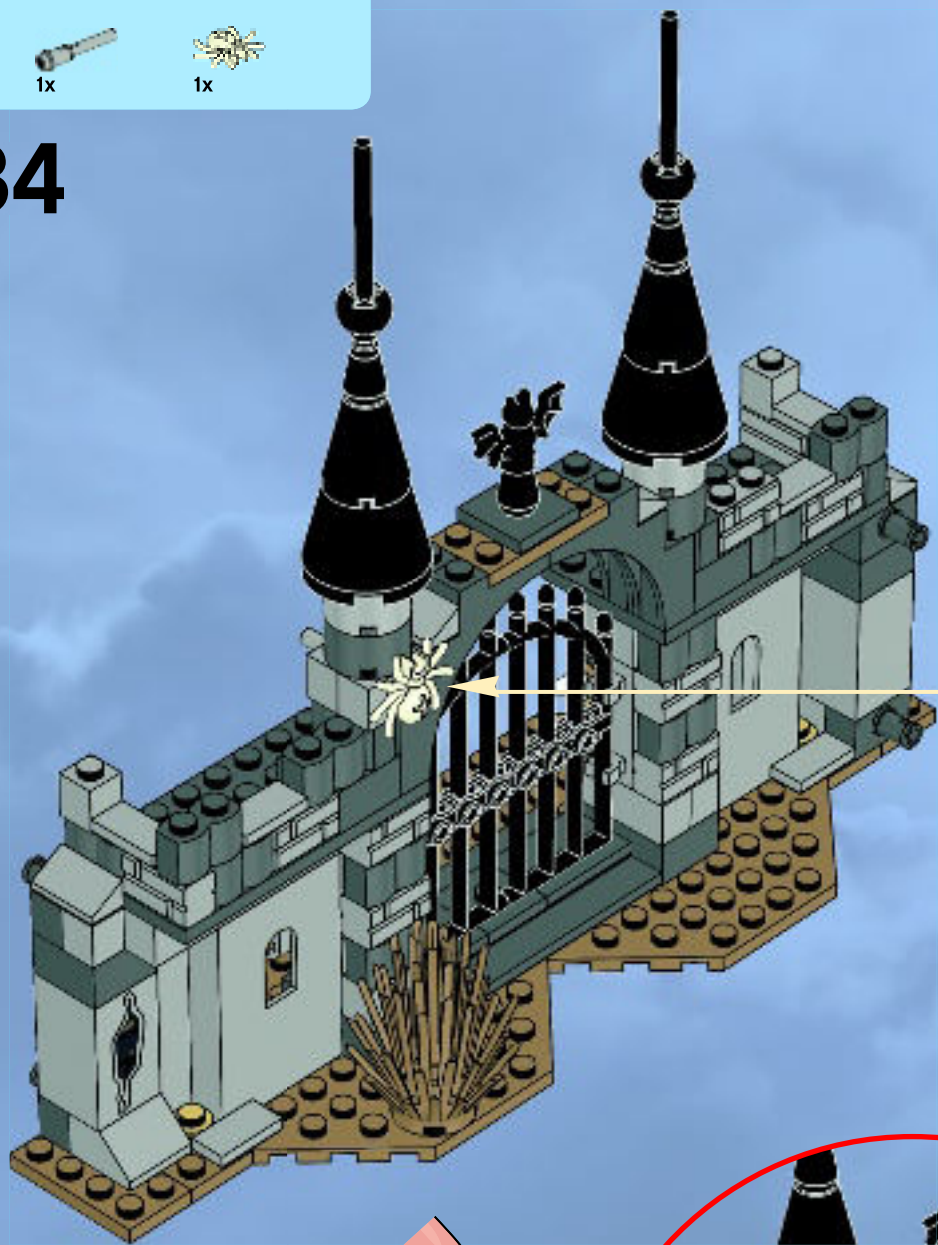



35



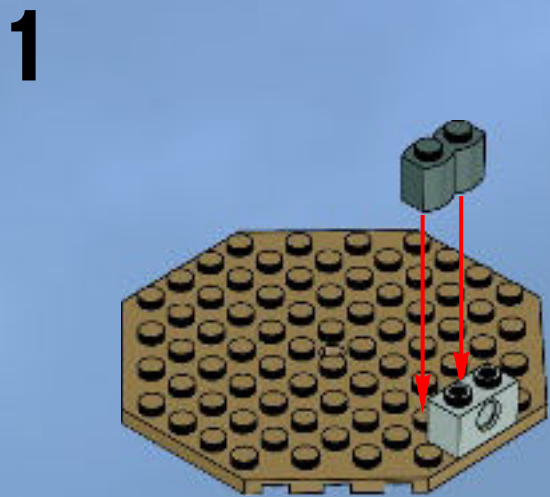
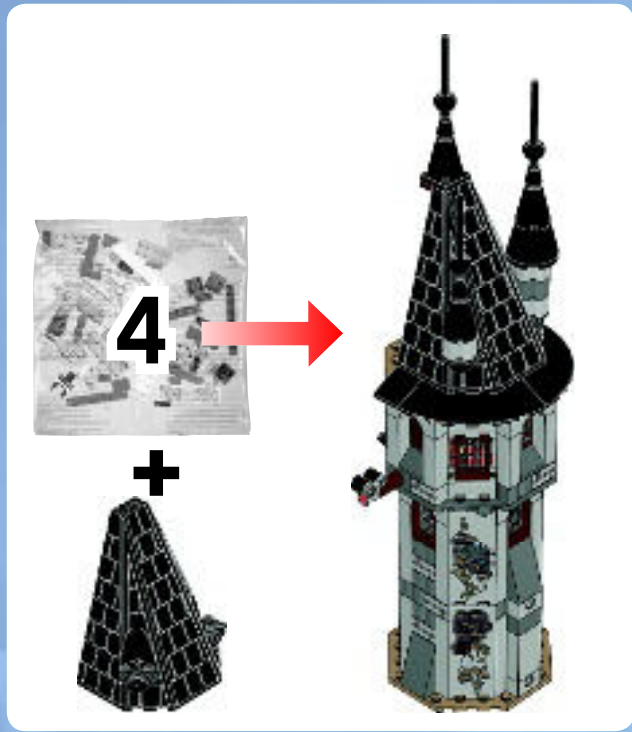

2

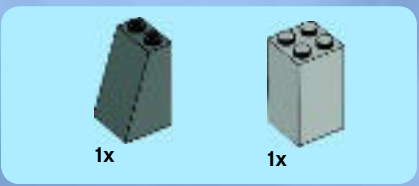

3







1x



1x



1x

# 4

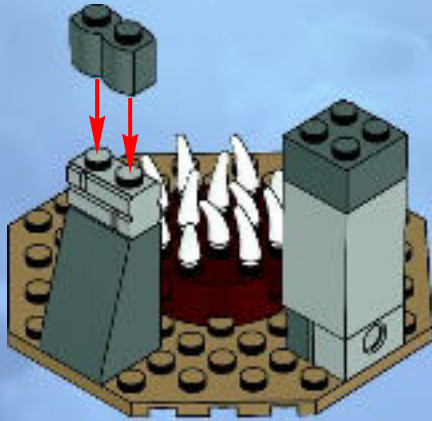

3x



1x

# 6

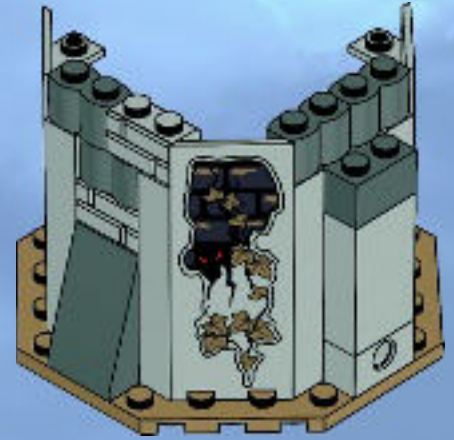

3x



# 5

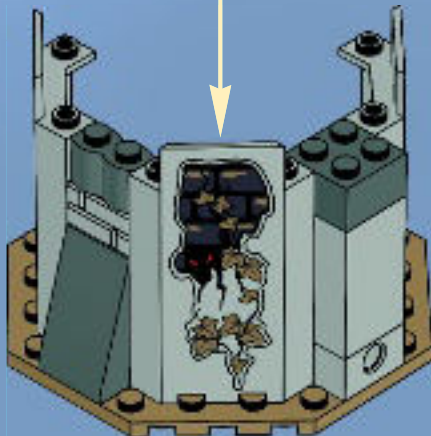

1x



1x



1x

# 7

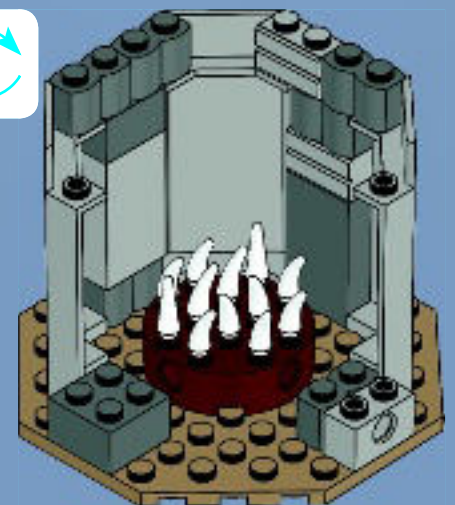



2x

8

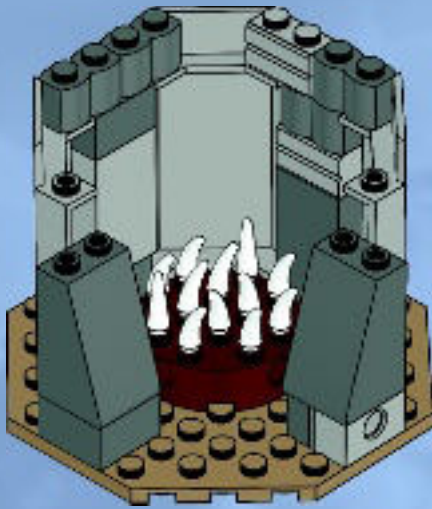

1x



1x

9

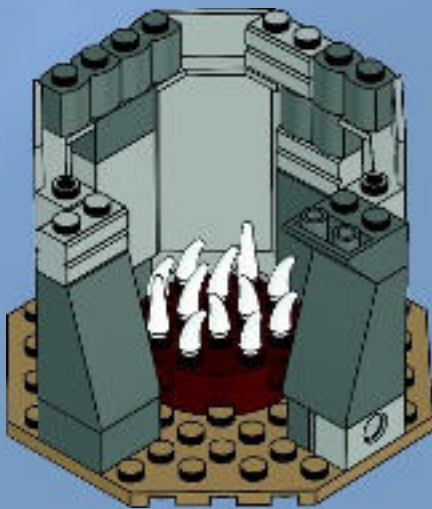

1x



1x

10

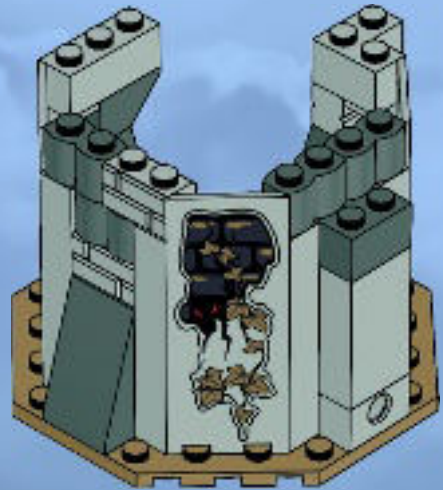



2x

# 11

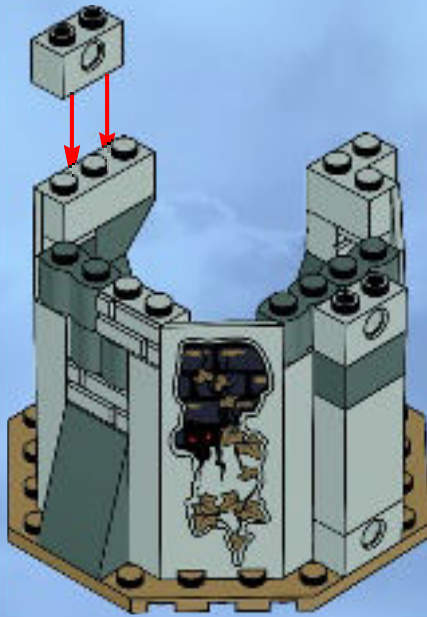

1x



1x



1x

# 12

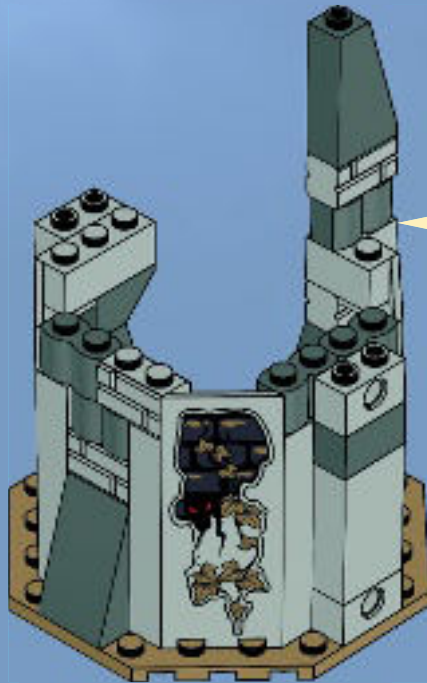

1

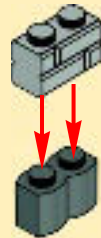

2

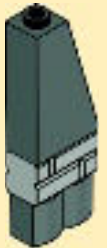



13

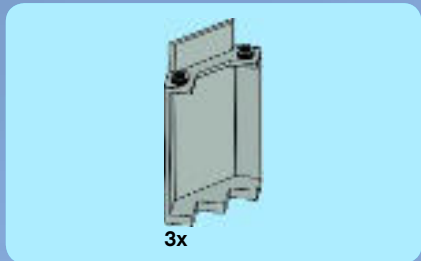
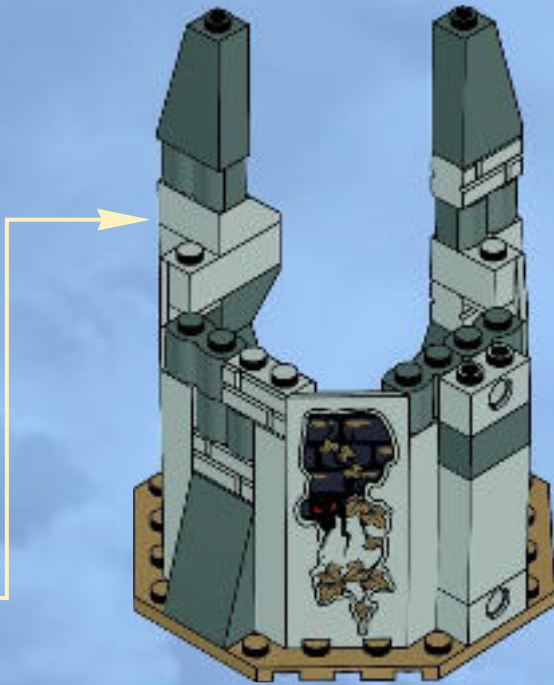
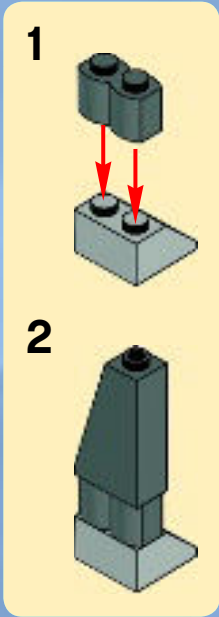

14

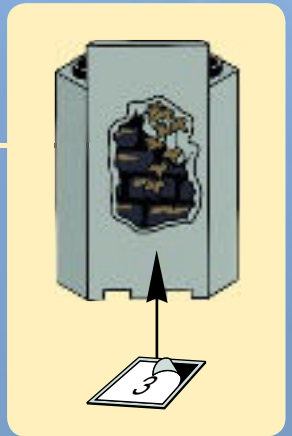
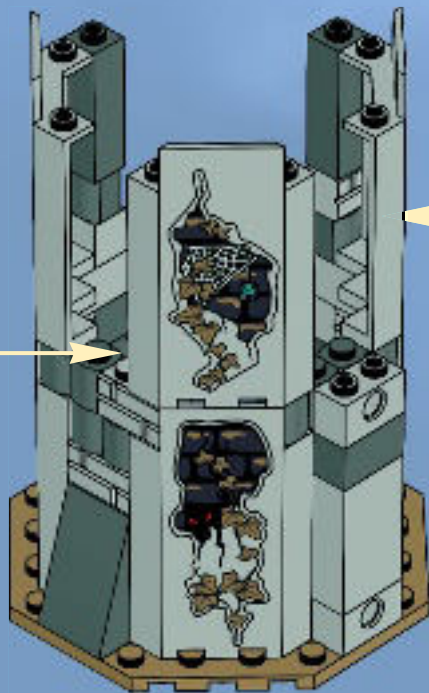
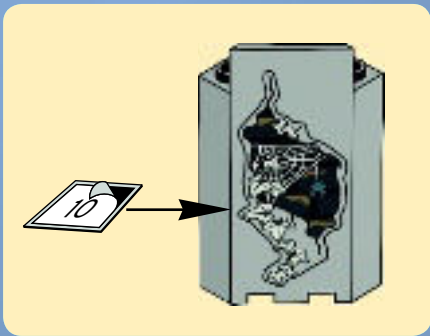





15

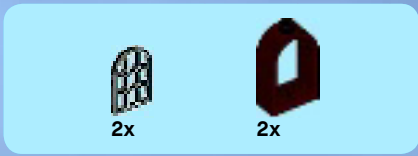
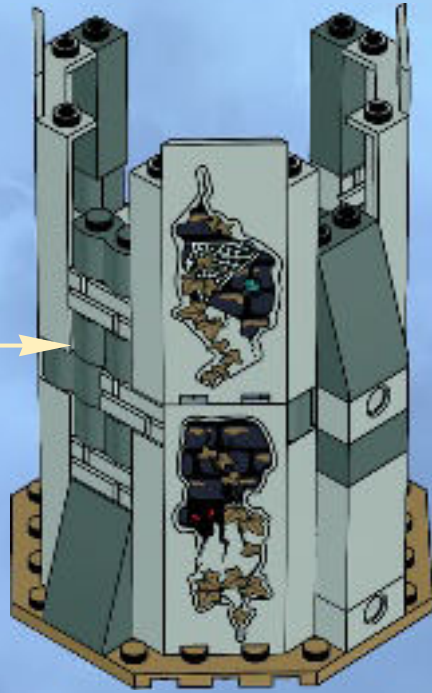
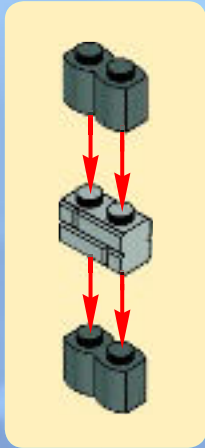

16

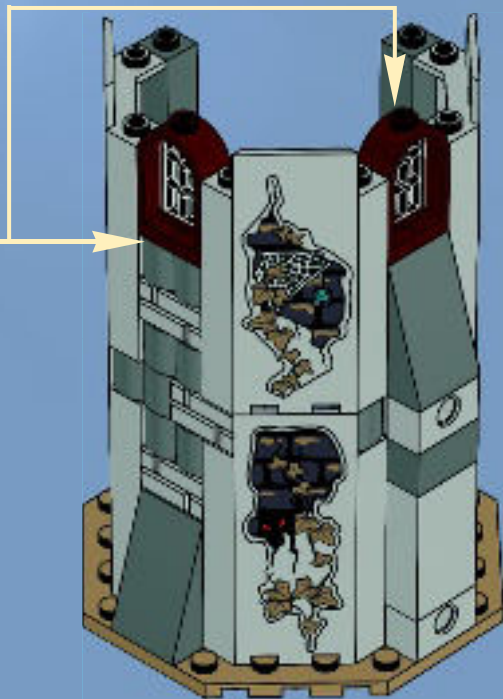
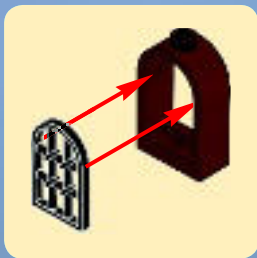



# 17

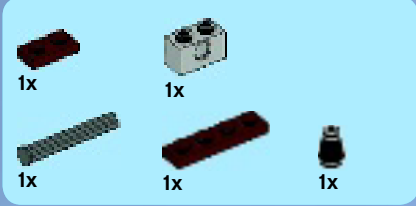
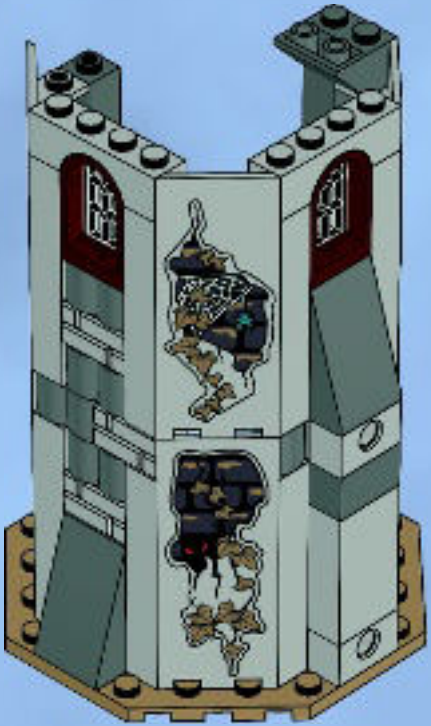

# 18

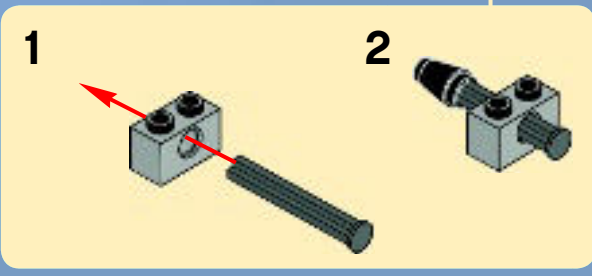

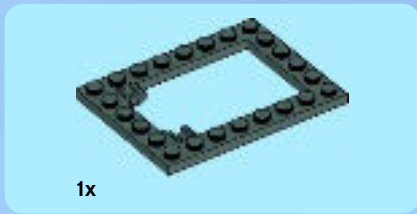

1x

# 19



2x

1x

1x

# 20

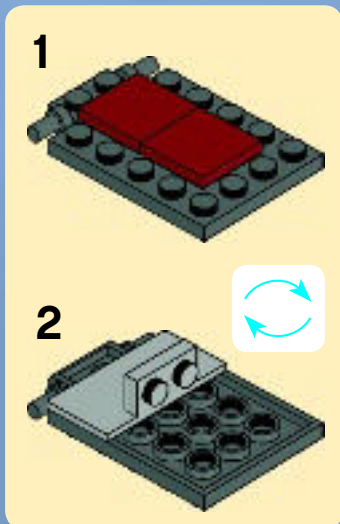

1

2

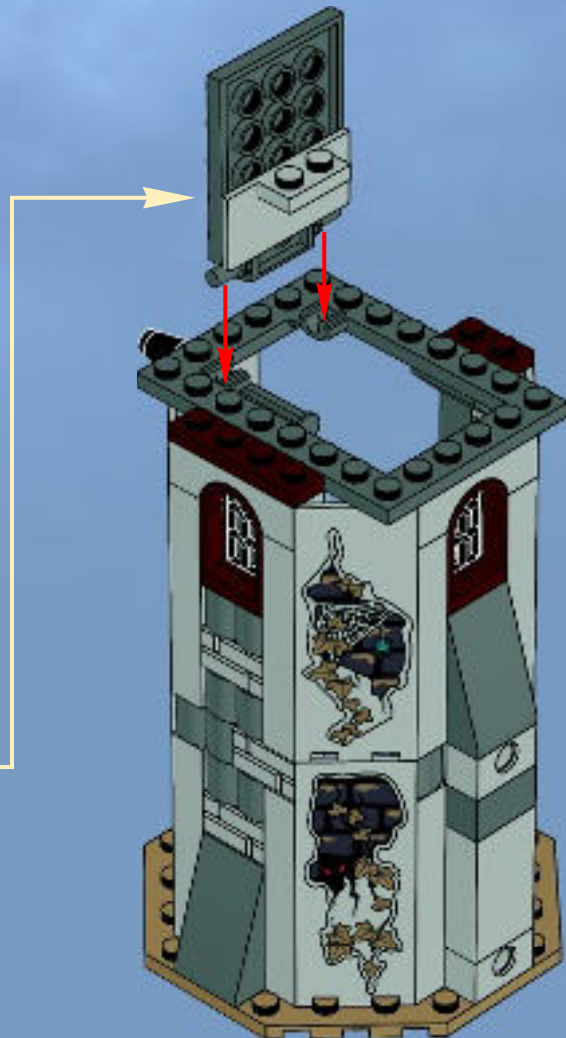



# 21

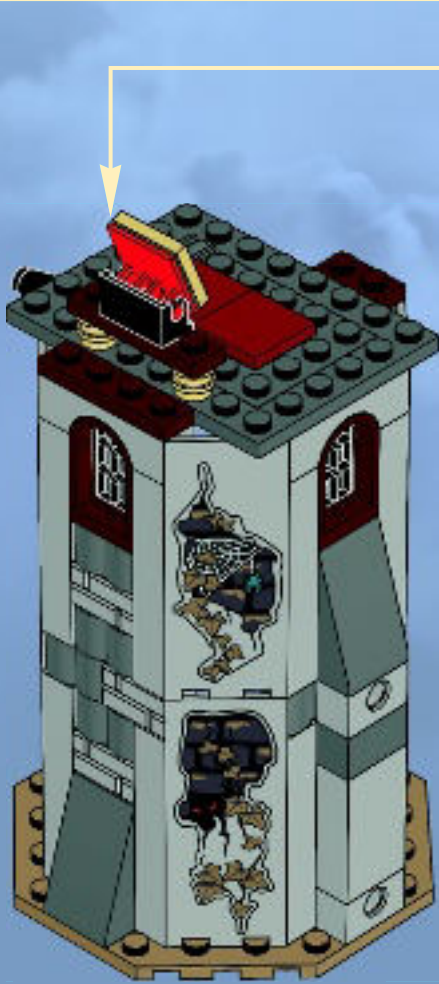
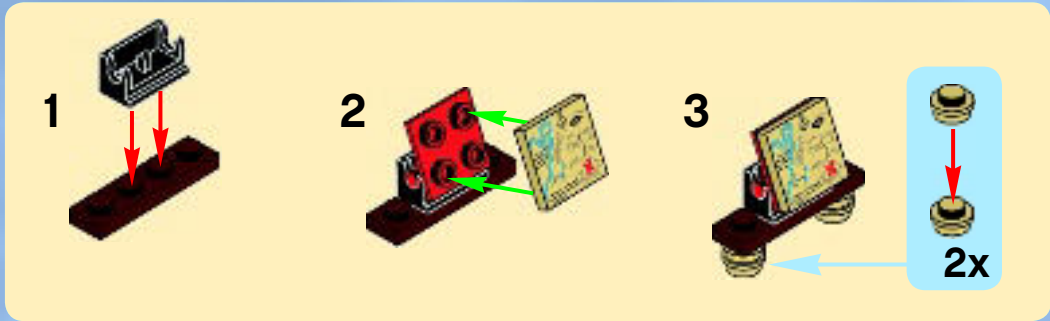





1

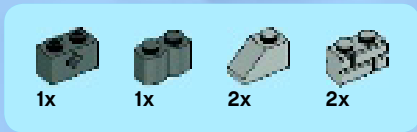

2

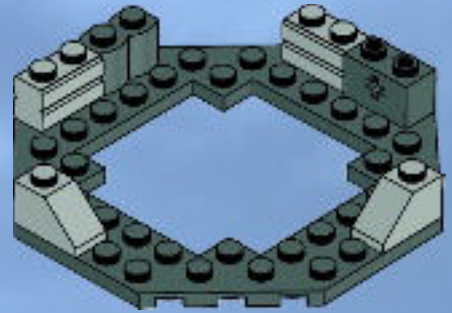

3

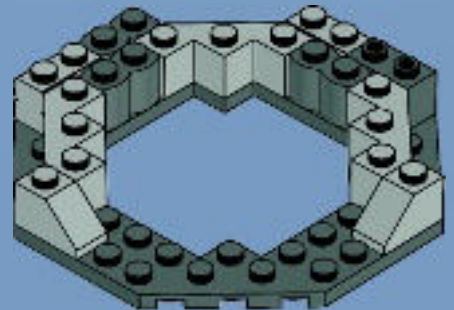

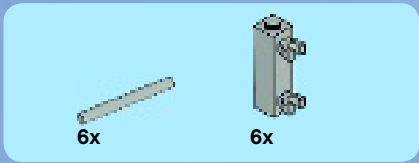

4

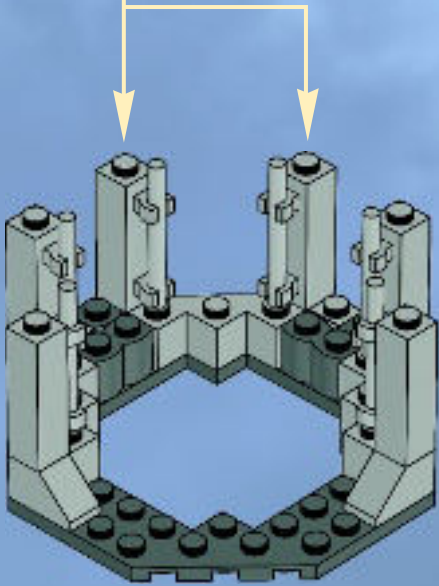
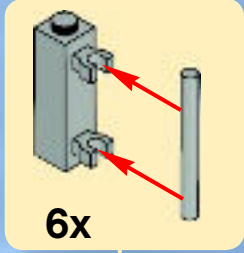

5

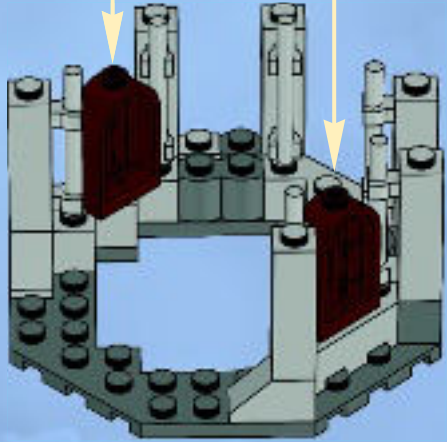
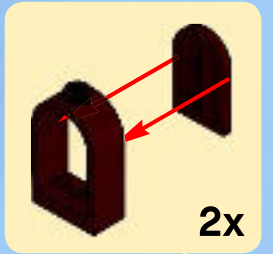

6

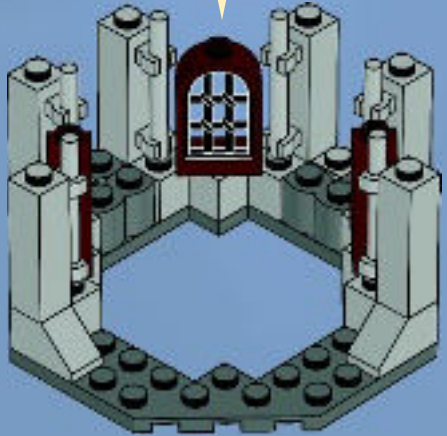
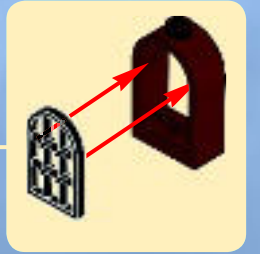



7

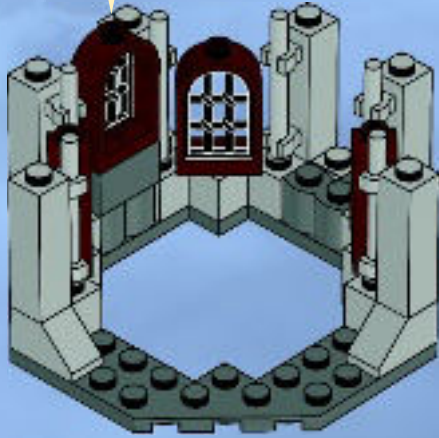
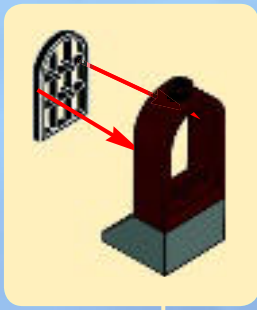

8

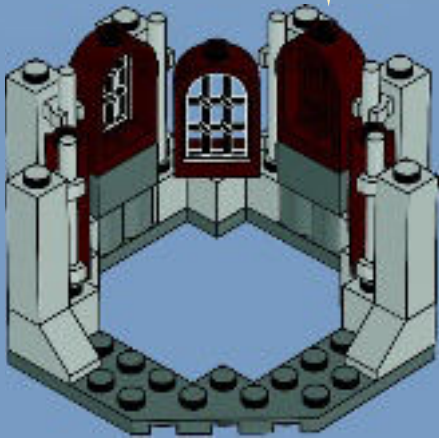
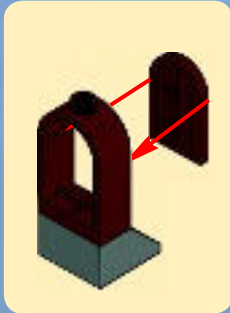



3x

# 9

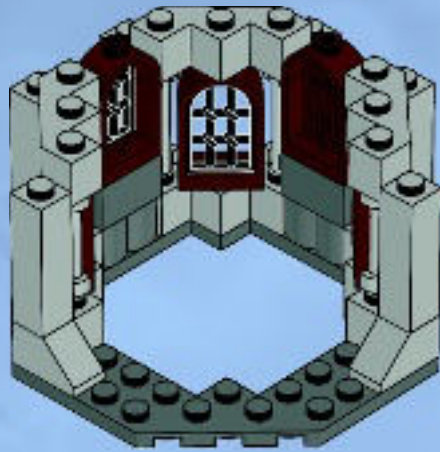

2x



2x

# 10

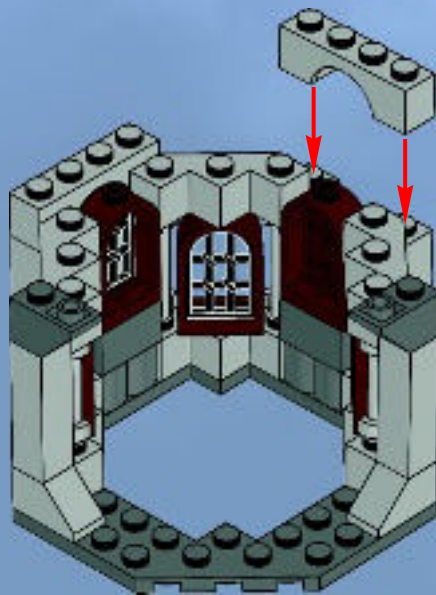





2x



2x



3x

# 11

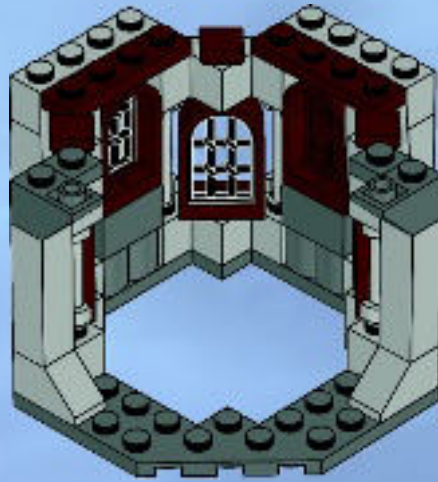

1x

# 12

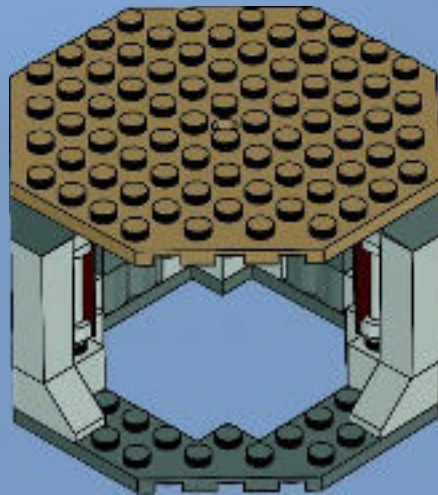

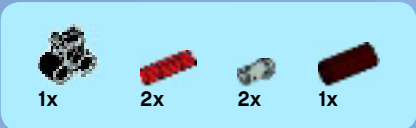

# 13

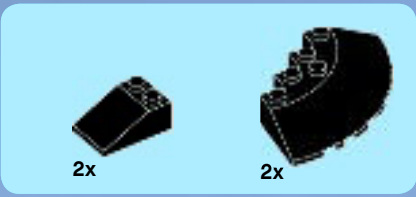
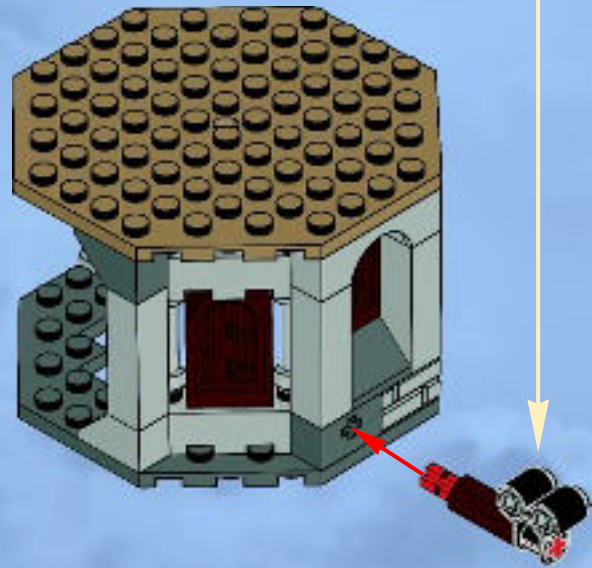
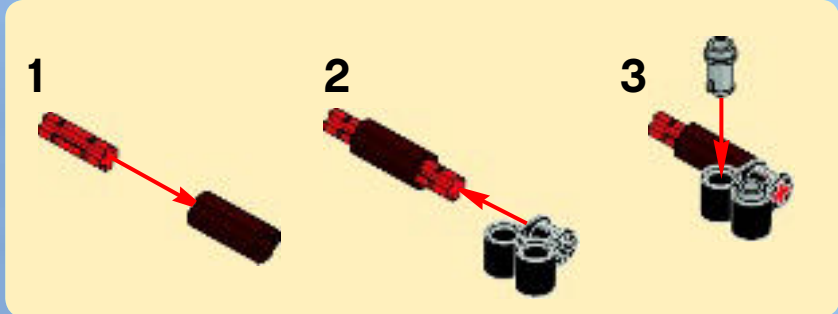

# 14

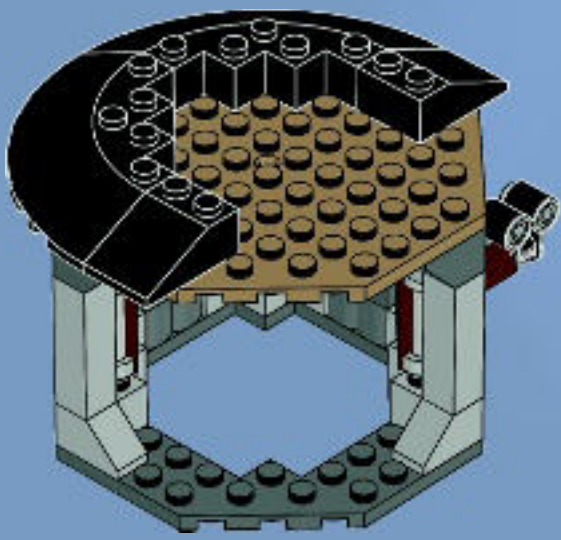



1x



1x



1x



1x



1x

# 15

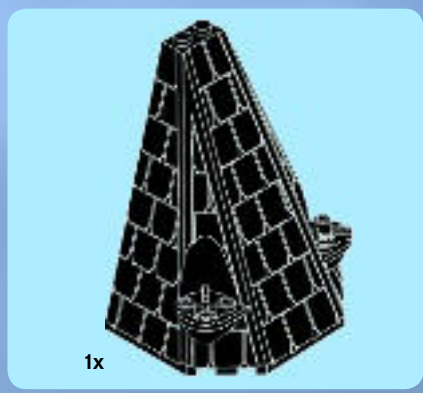
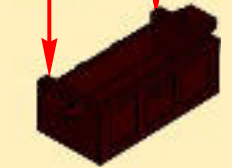
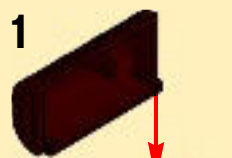
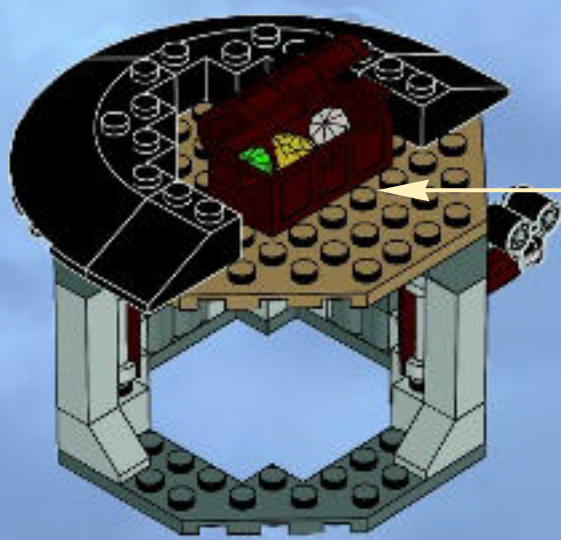

1x

# 16

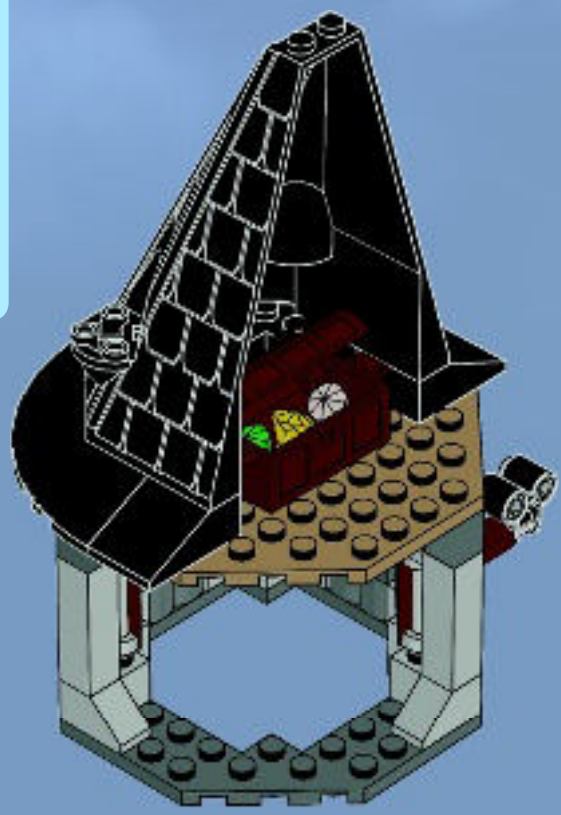

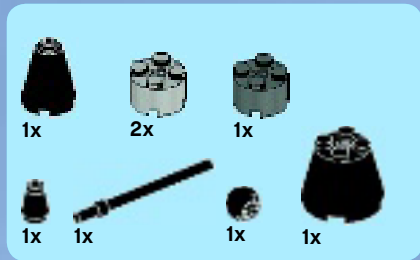

17

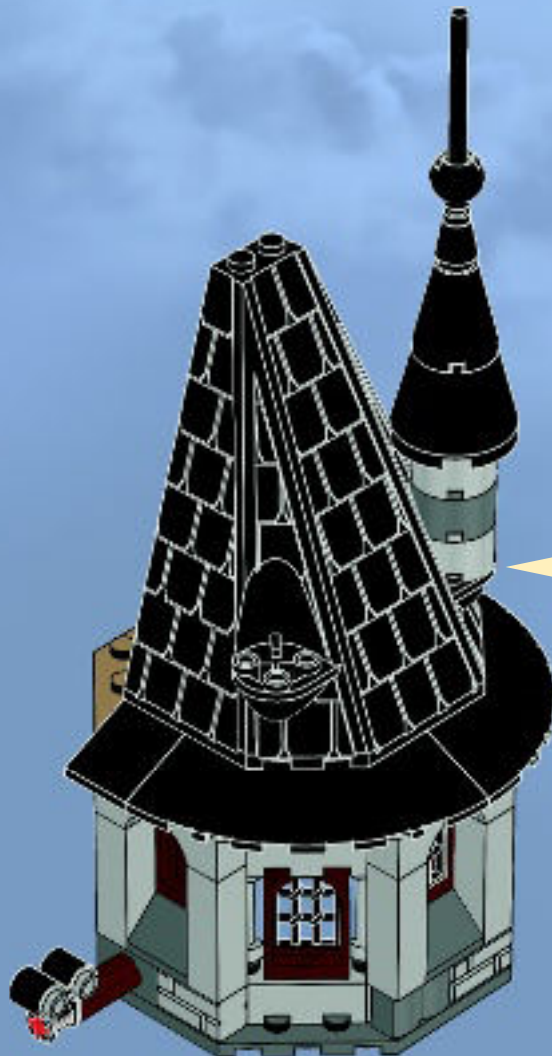
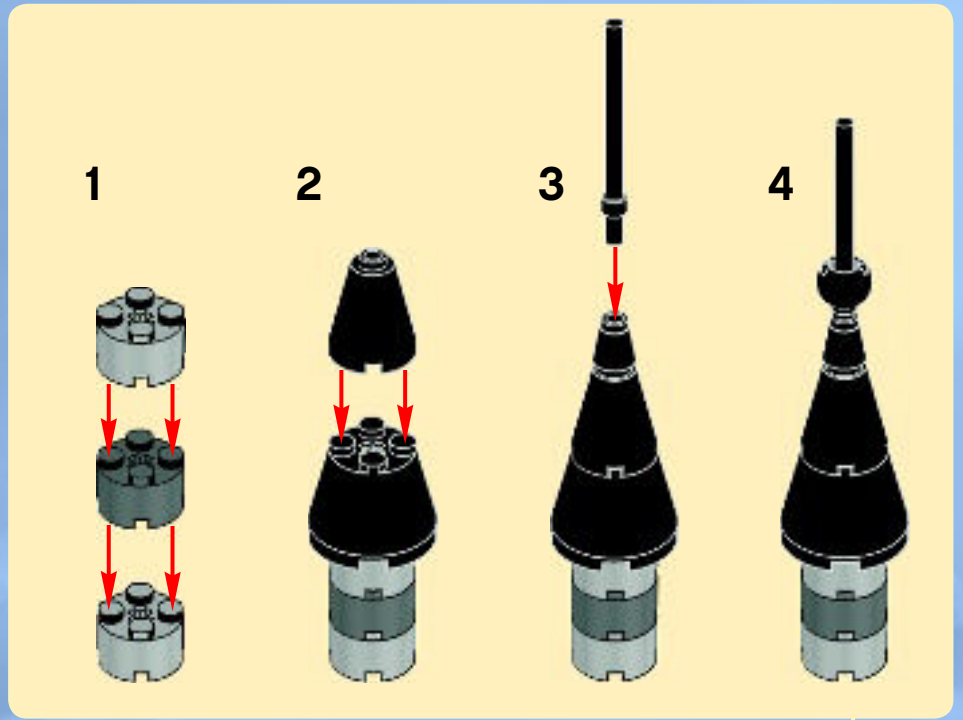



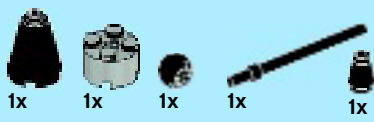

18

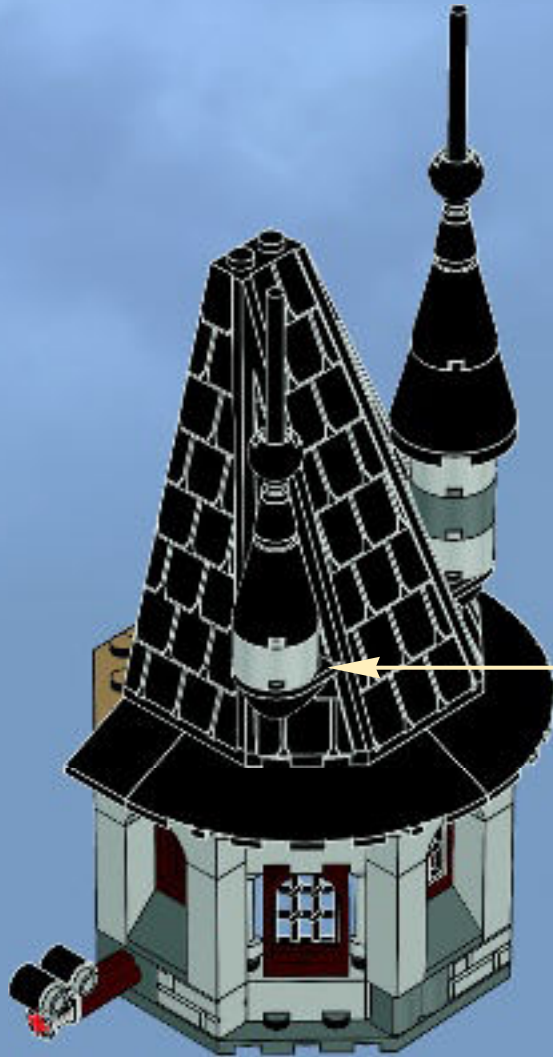
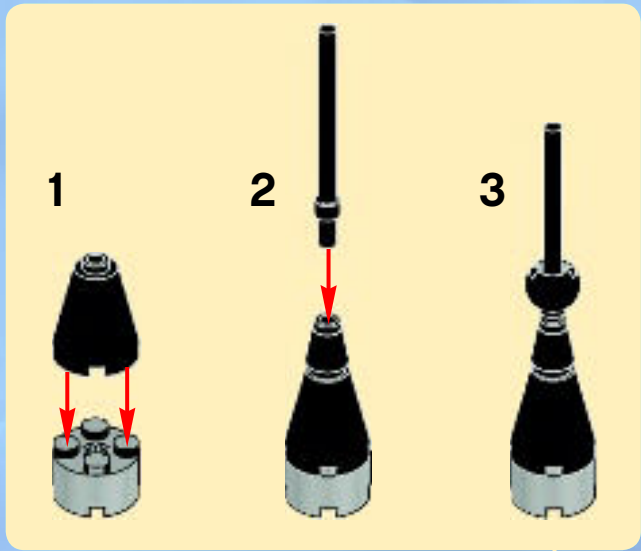



19

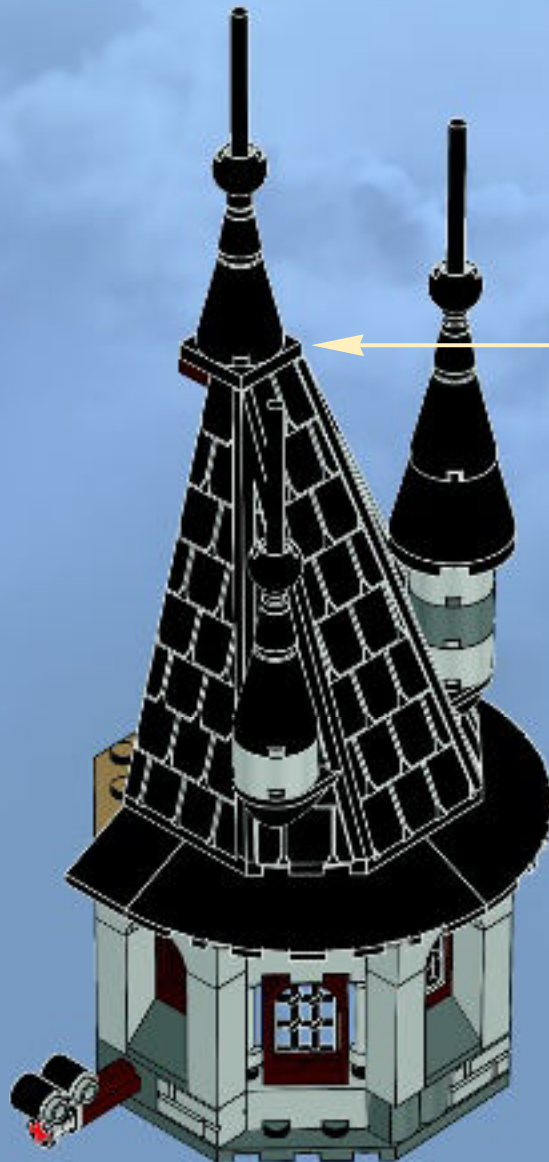
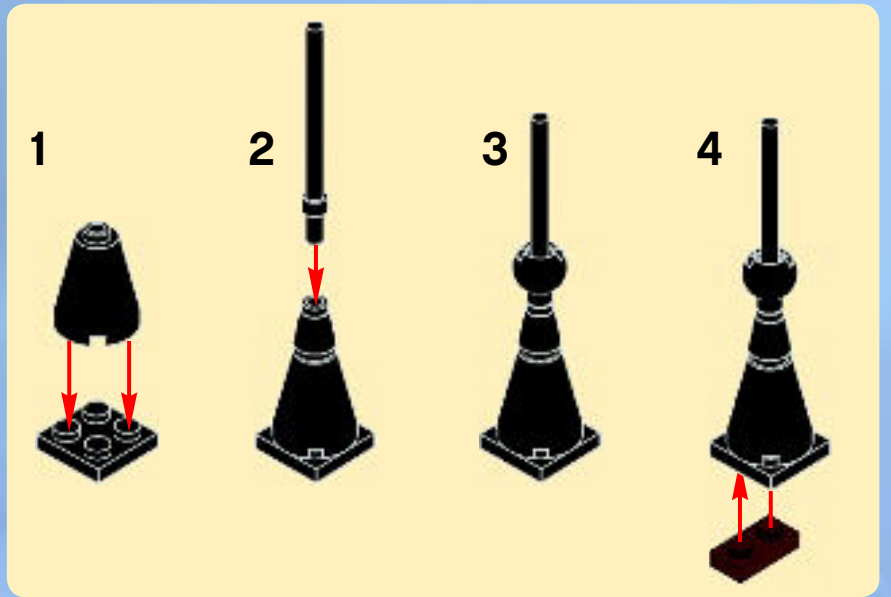

20







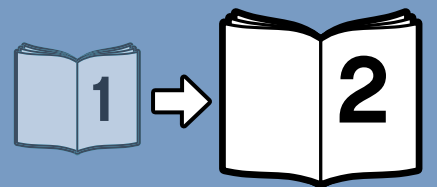



# MONSTER FIGHTERS



LEGO and the LEGO logo are trademarks of the/son des marques de commerce de/son marcas registradas de LEGO Group. ©2012 The LEGO Group.

6032890 / 6032892



[www.LEGO.com](http://www.LEGO.com)





# MONSTER FIGHTERS

9468



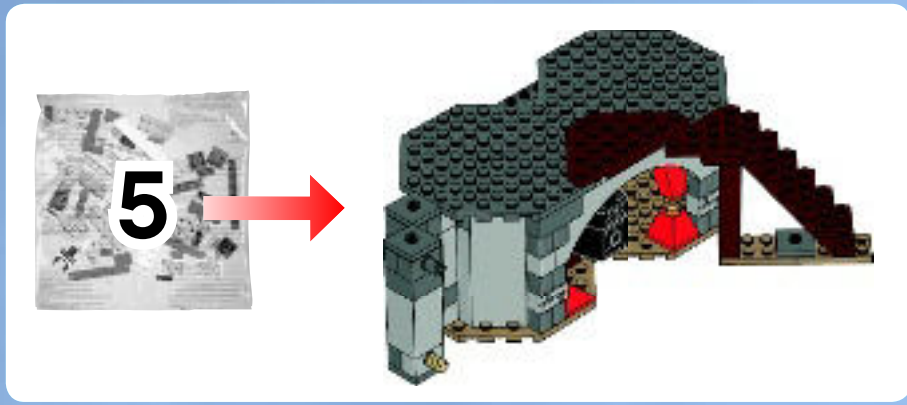

1

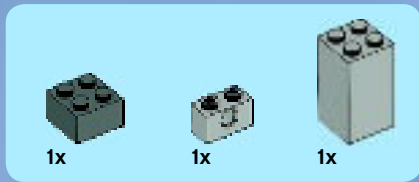
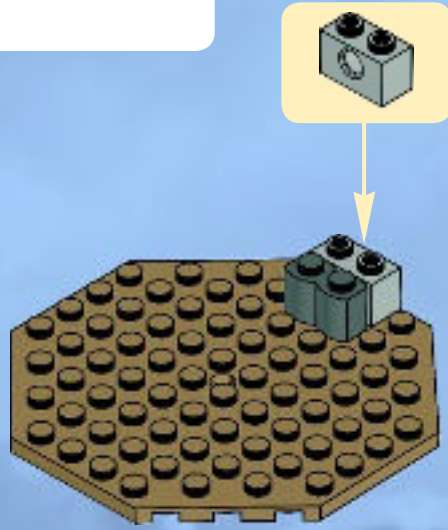

2

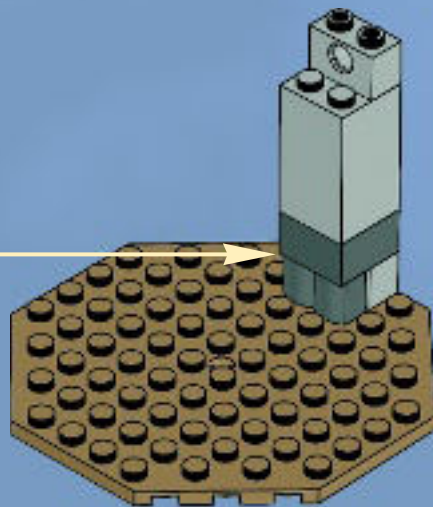
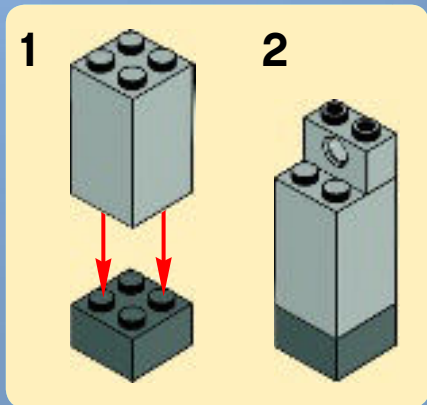



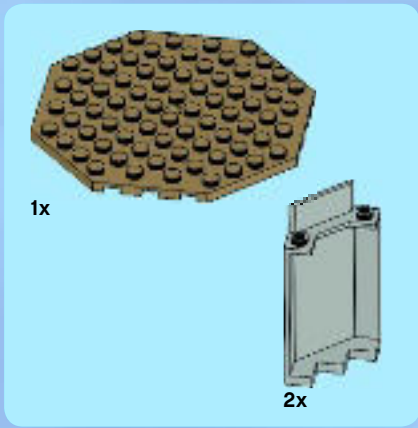

3

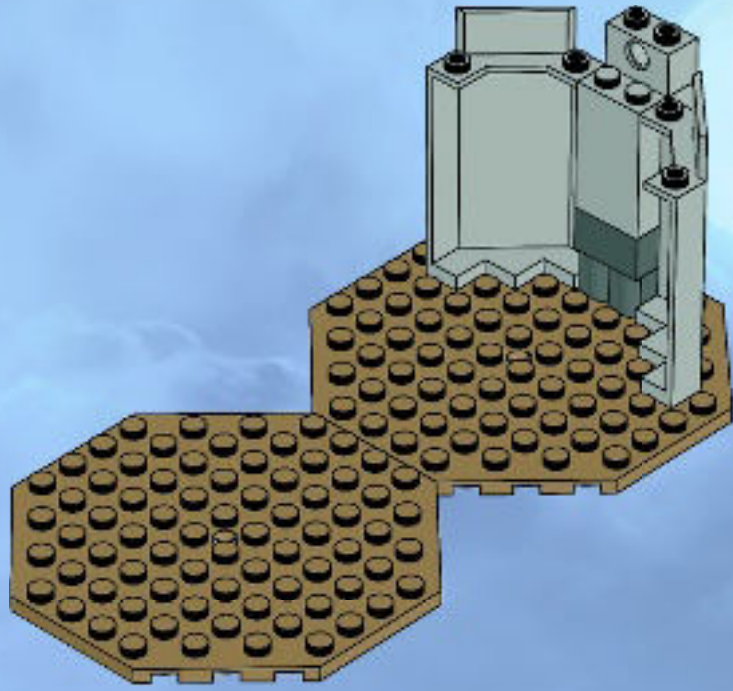

4

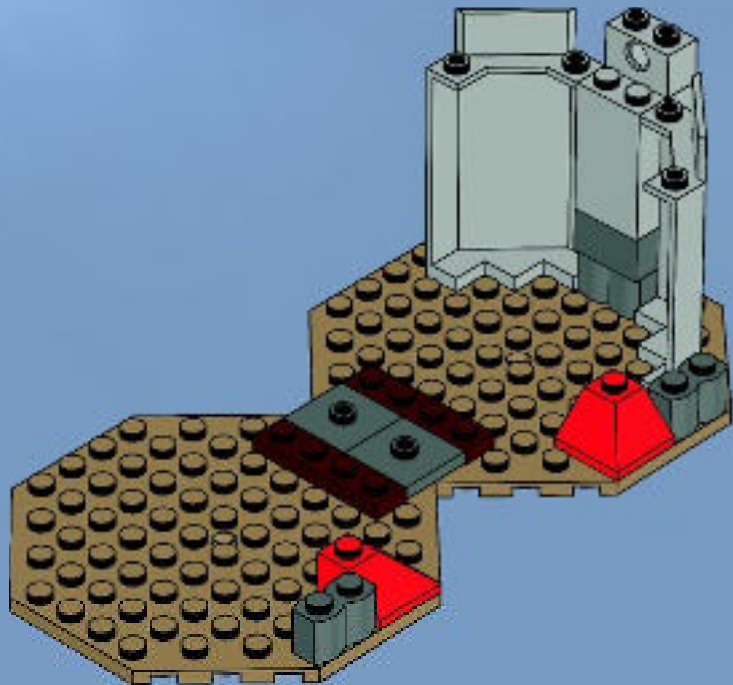

2x 4x 2x

5

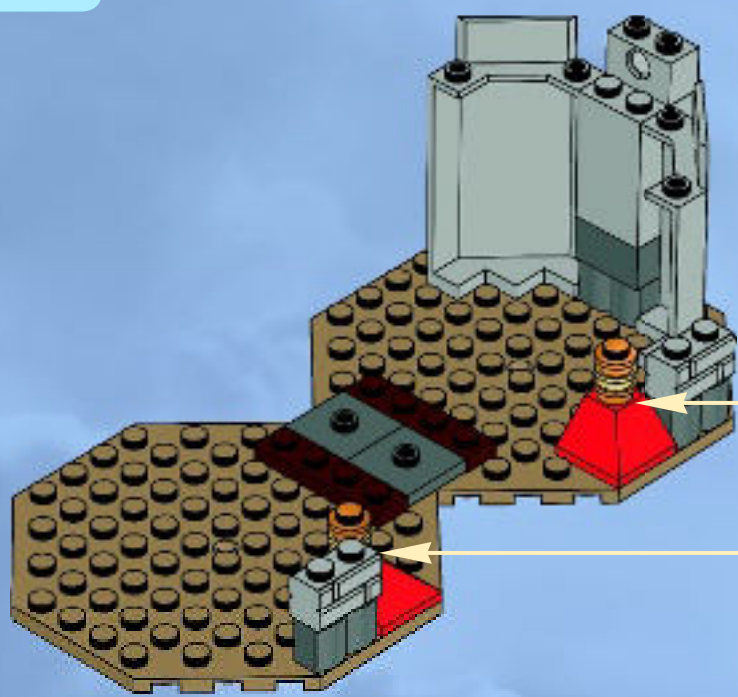

2x

2x 2x

6

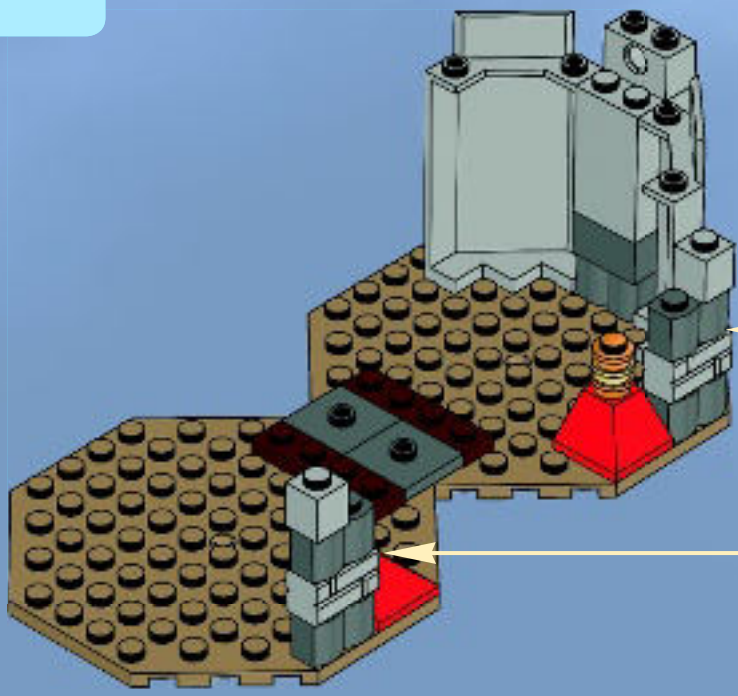

2x



7

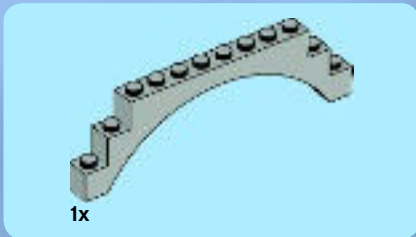
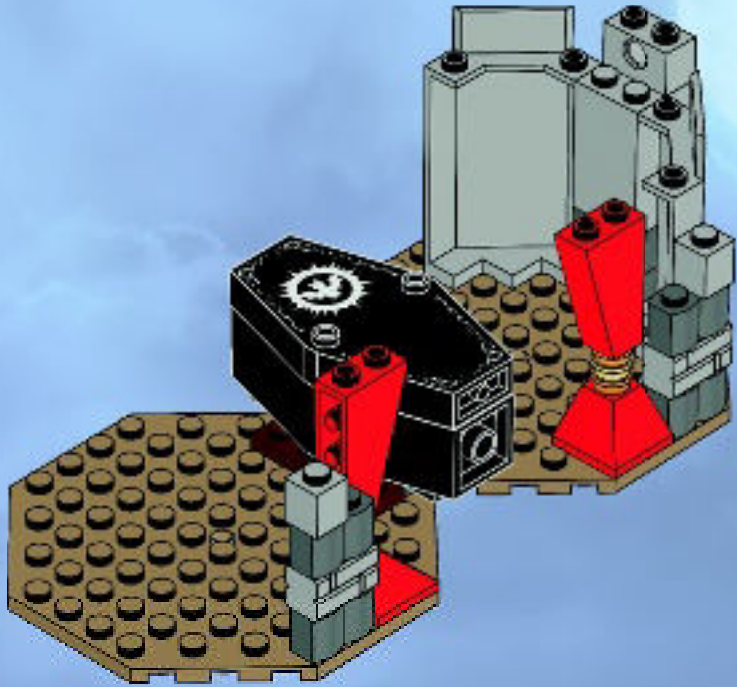

8

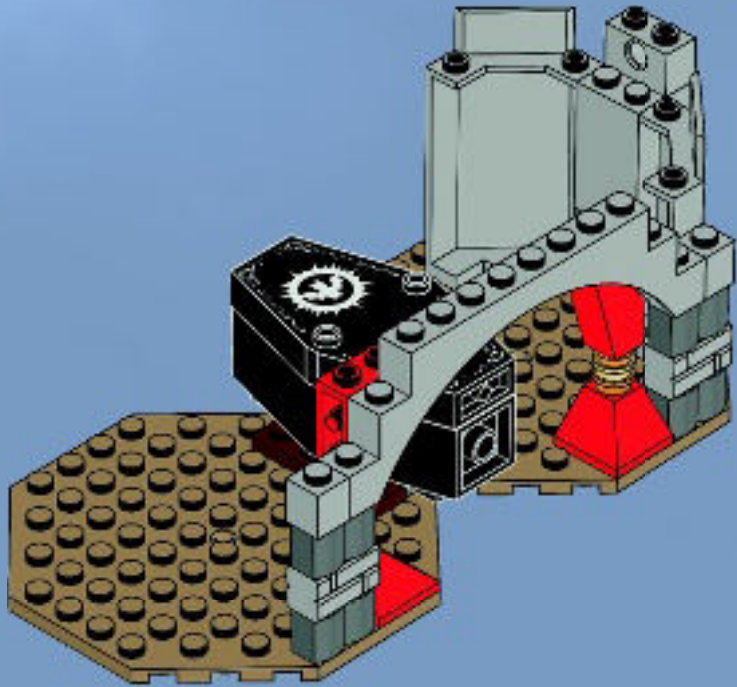



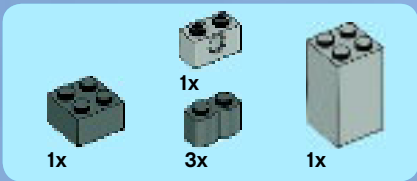

# 9

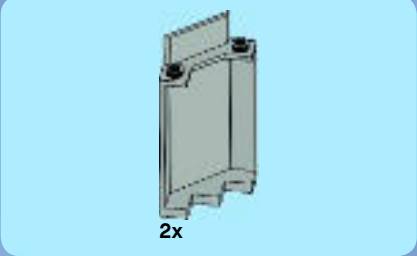
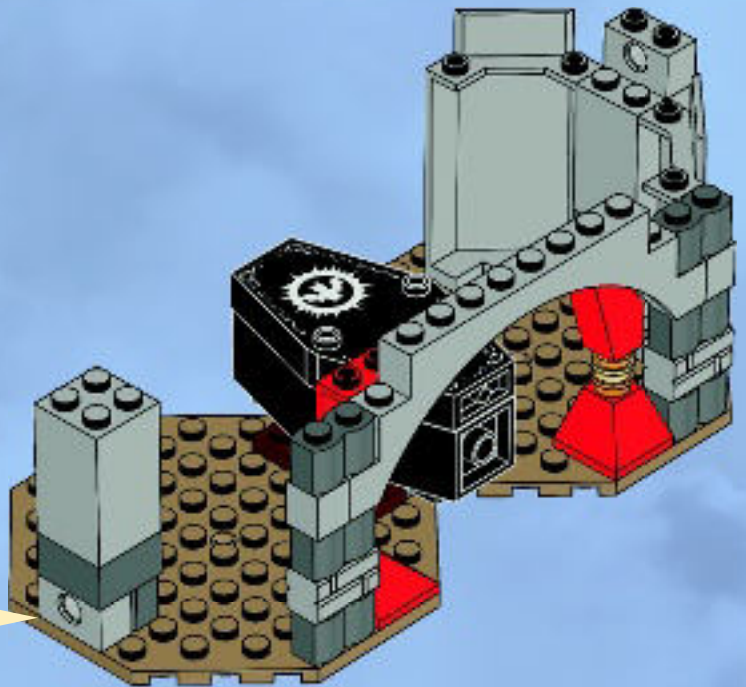
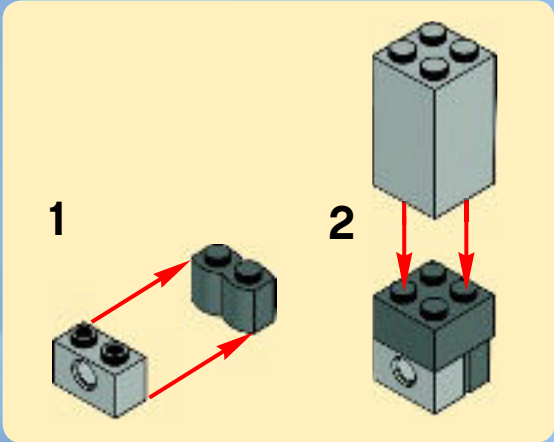

# 10

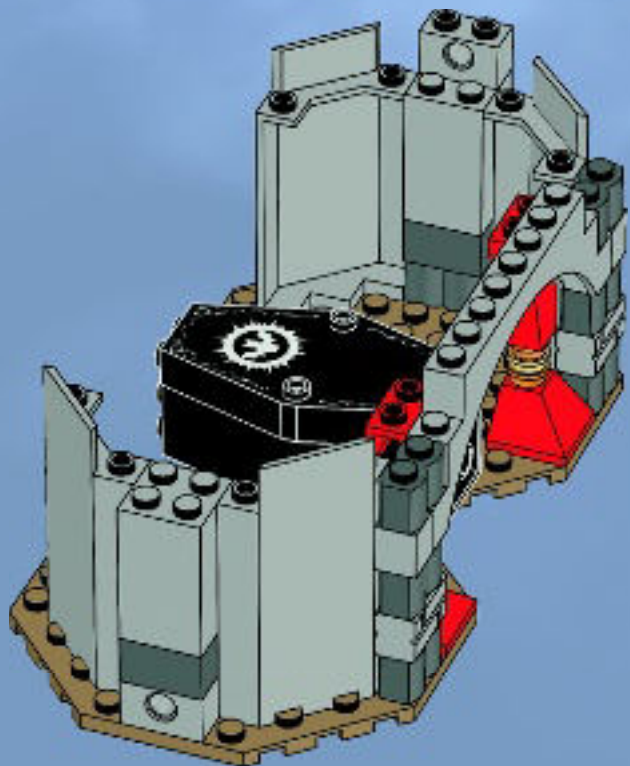



5x

# 11

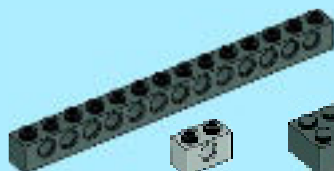
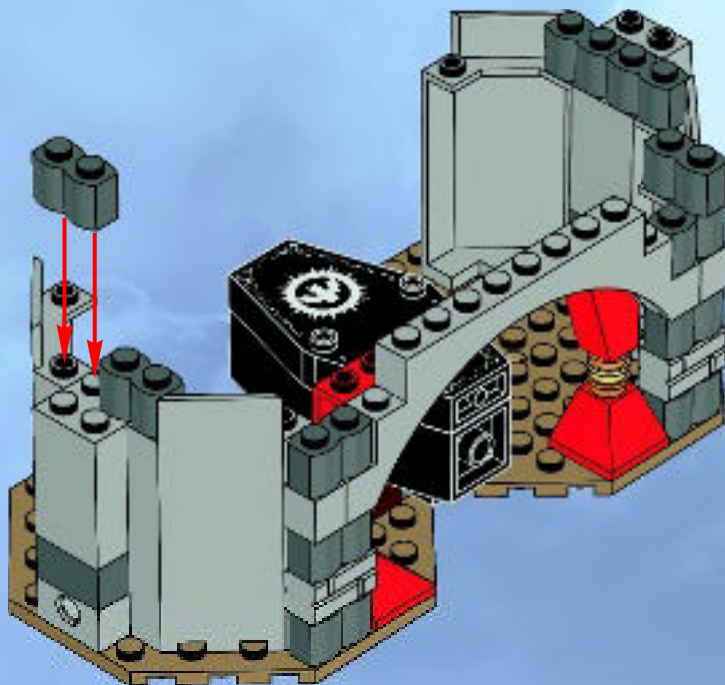

1x

1x

1x

# 12

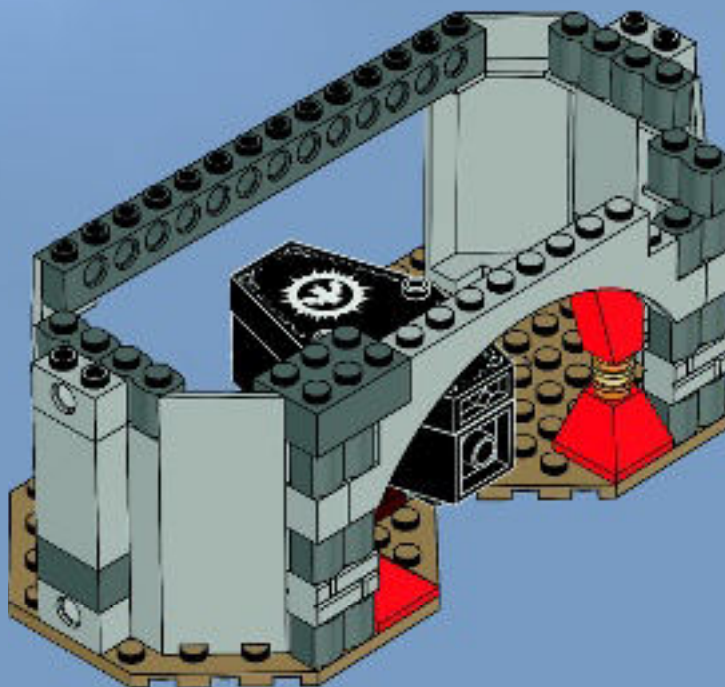



1

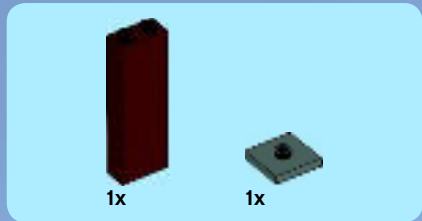
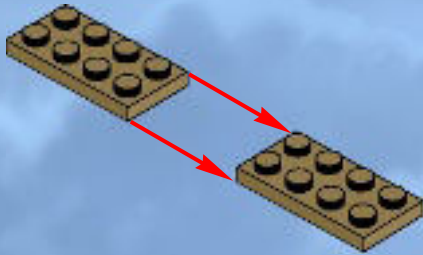

2

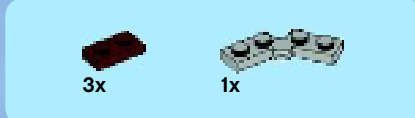
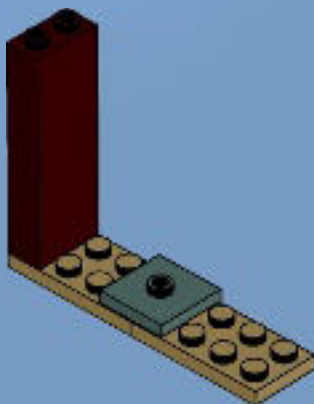

3

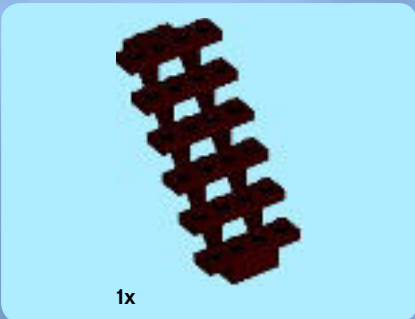
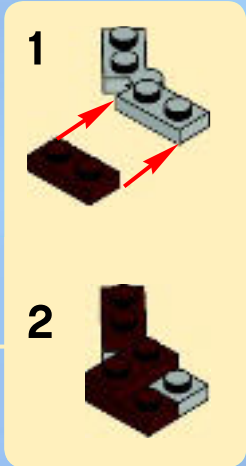
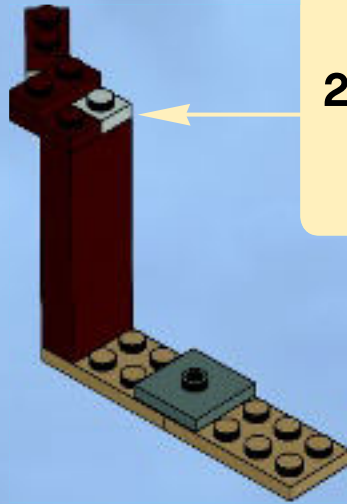

4

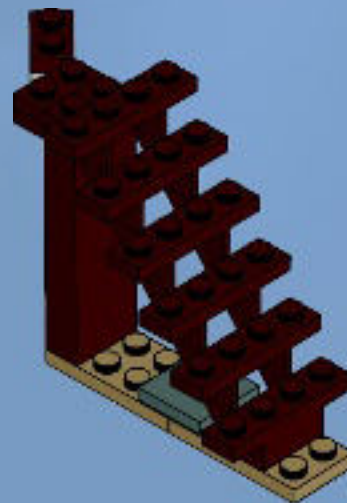





1x



1x

5

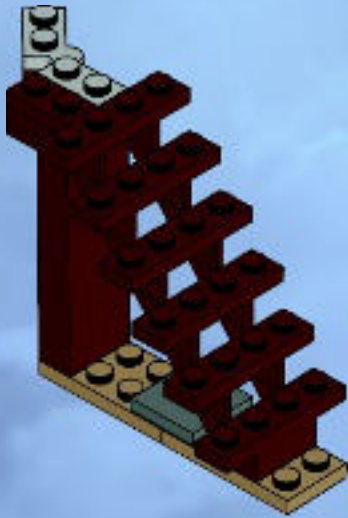

1x

6

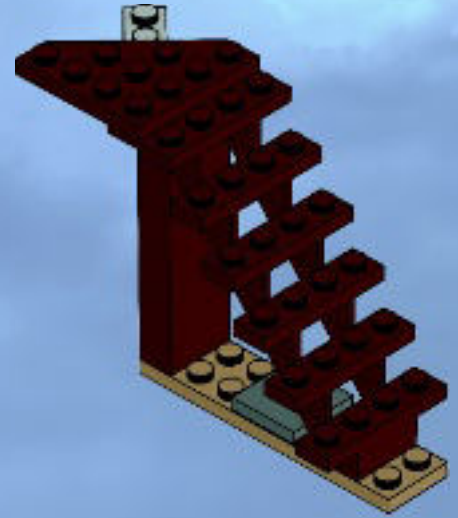

13

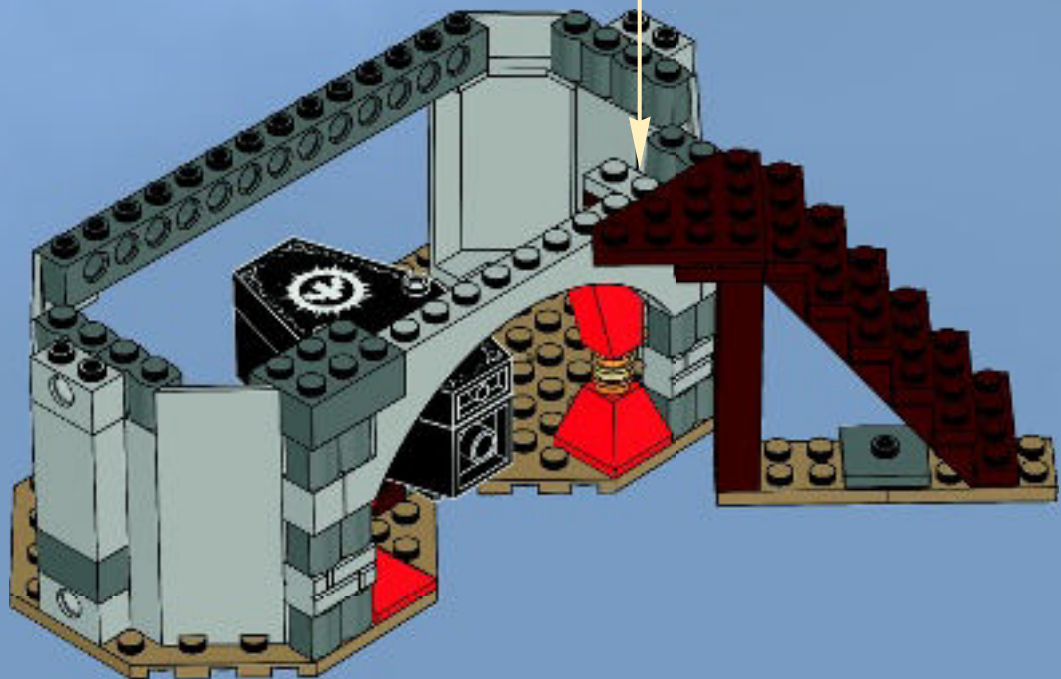



2x

# 14

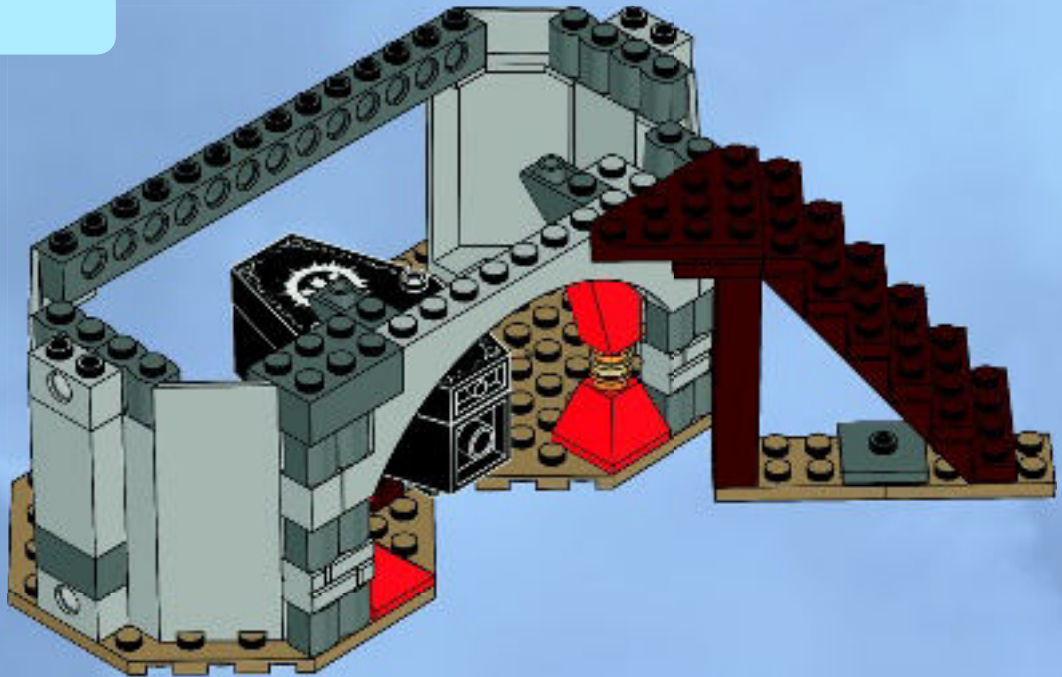

2x

1x

# 15

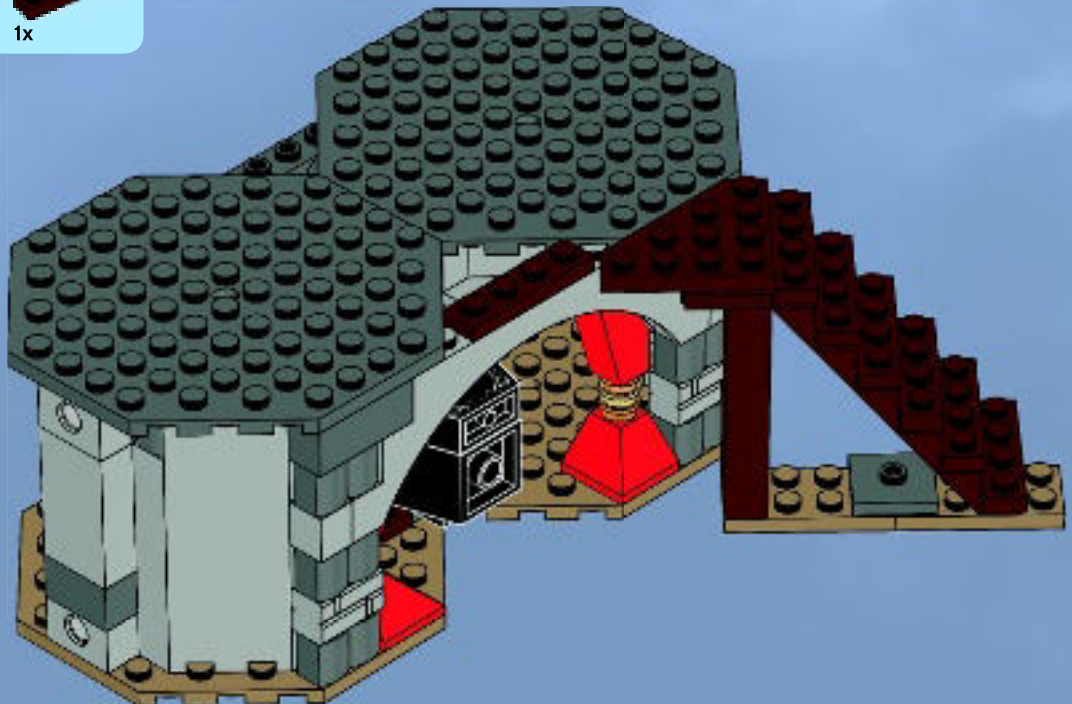



2x

# 16

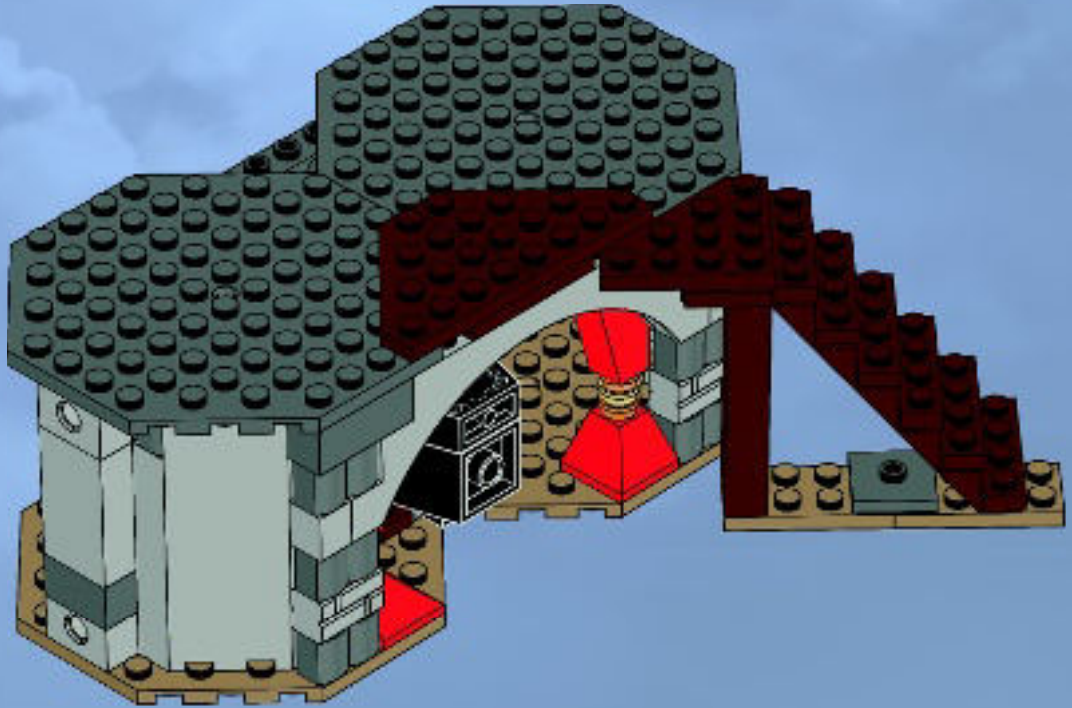



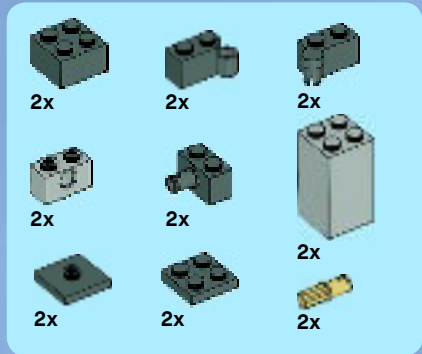

17

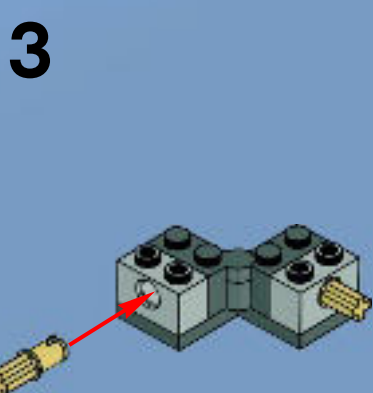
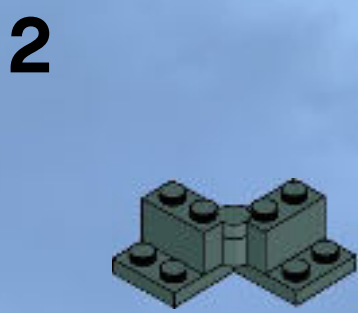
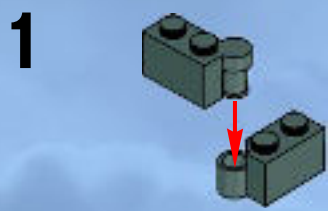

4

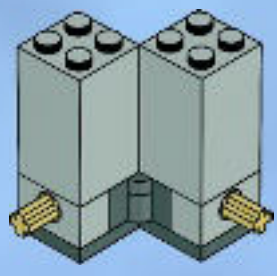

5

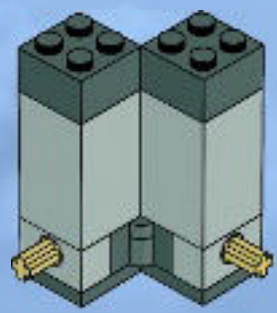

6

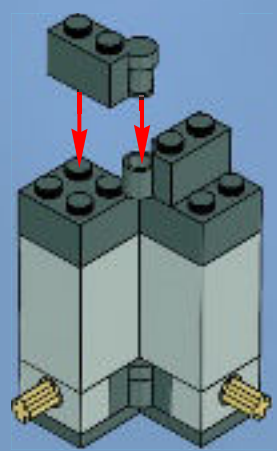

7

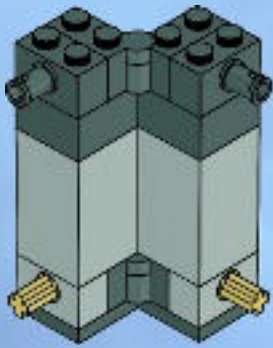

8

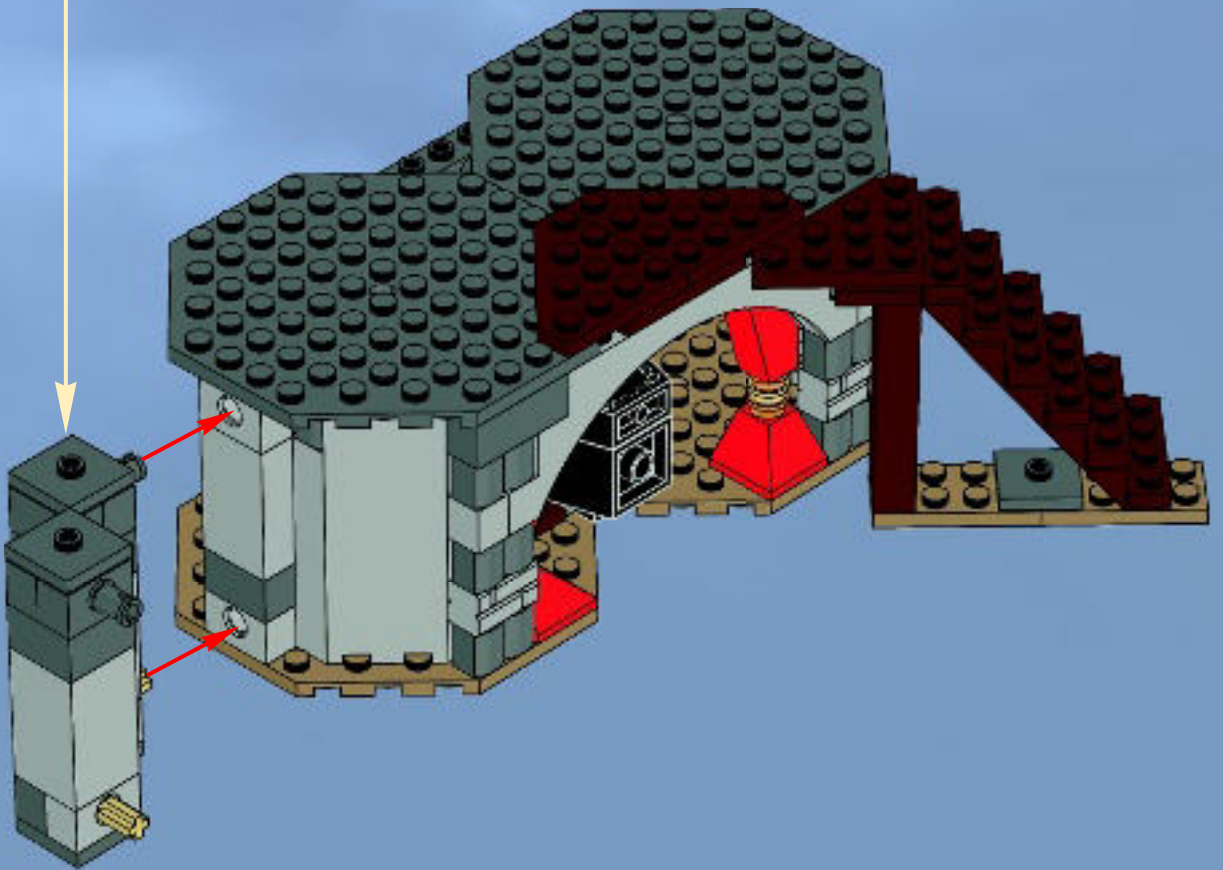
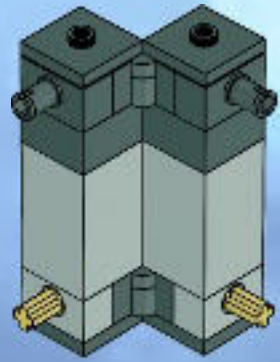

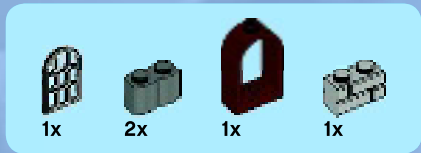
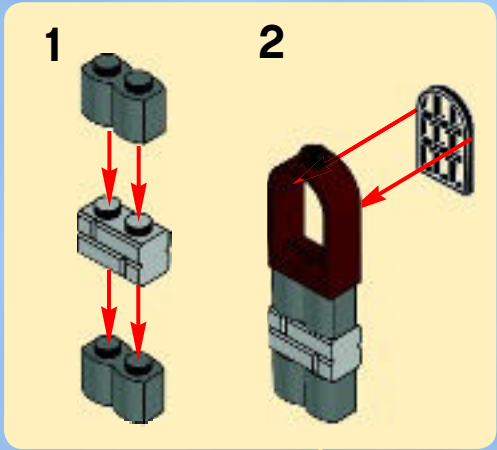
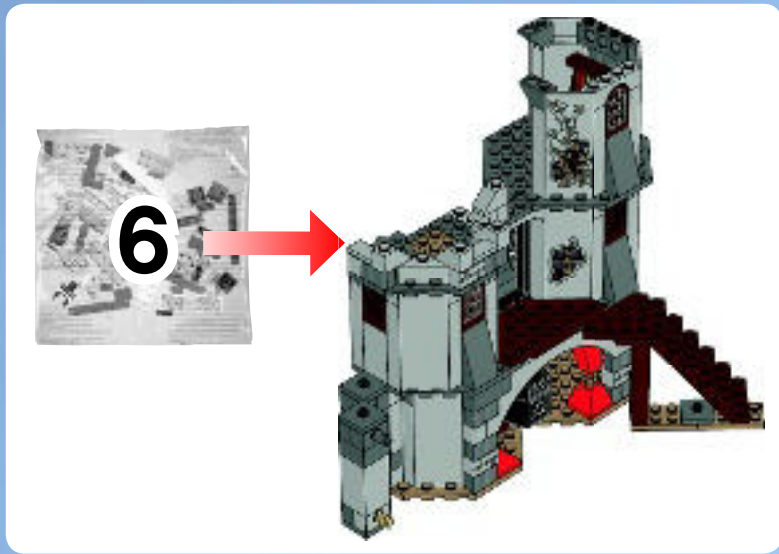

18





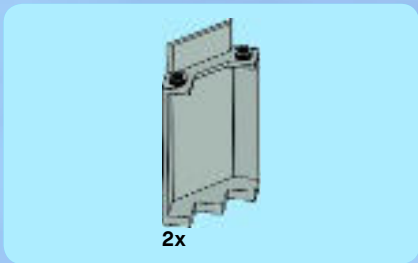

19

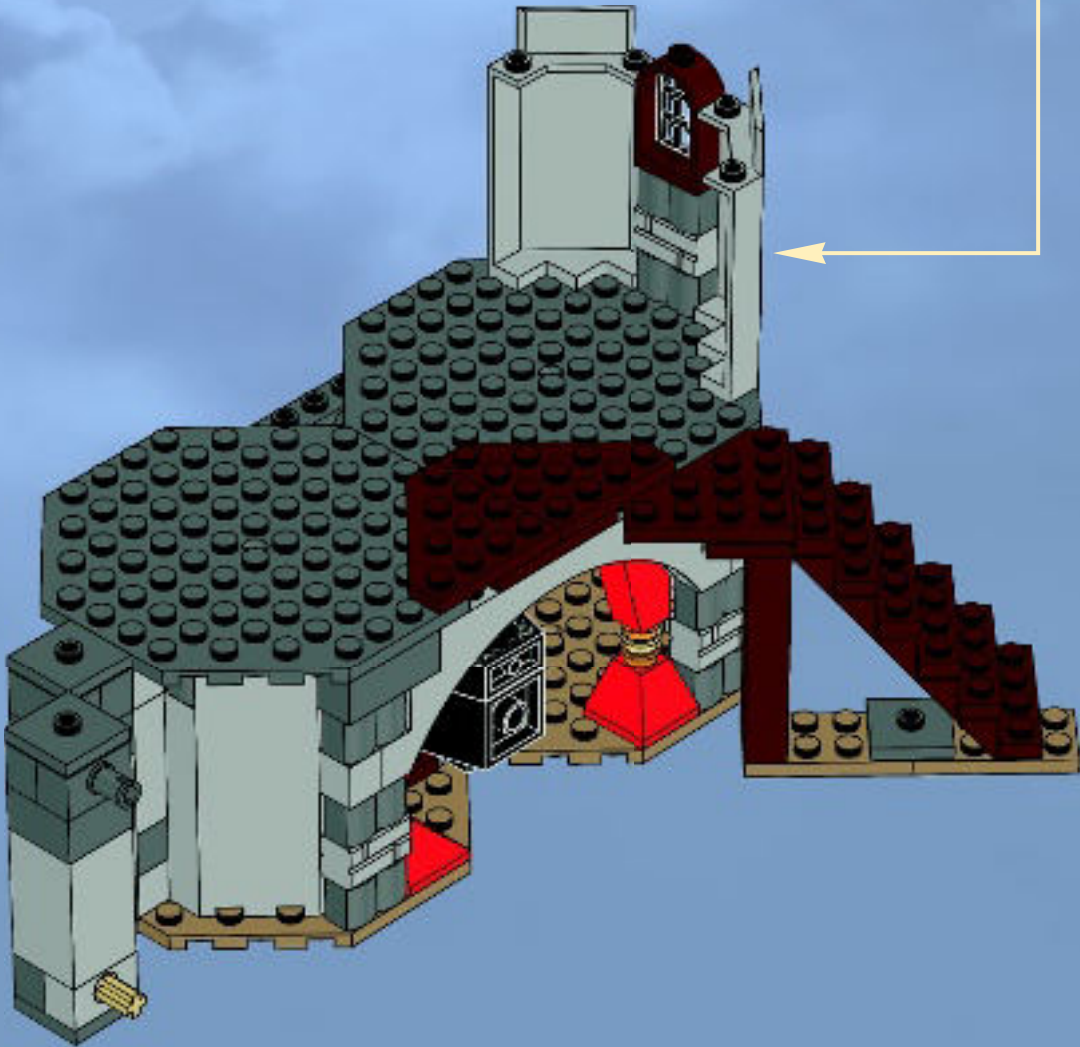
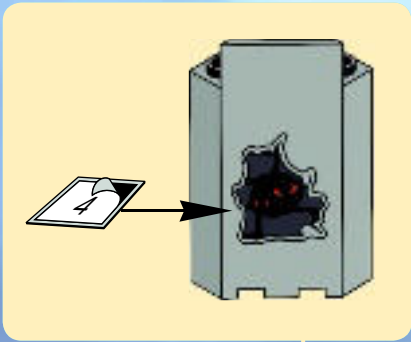



20

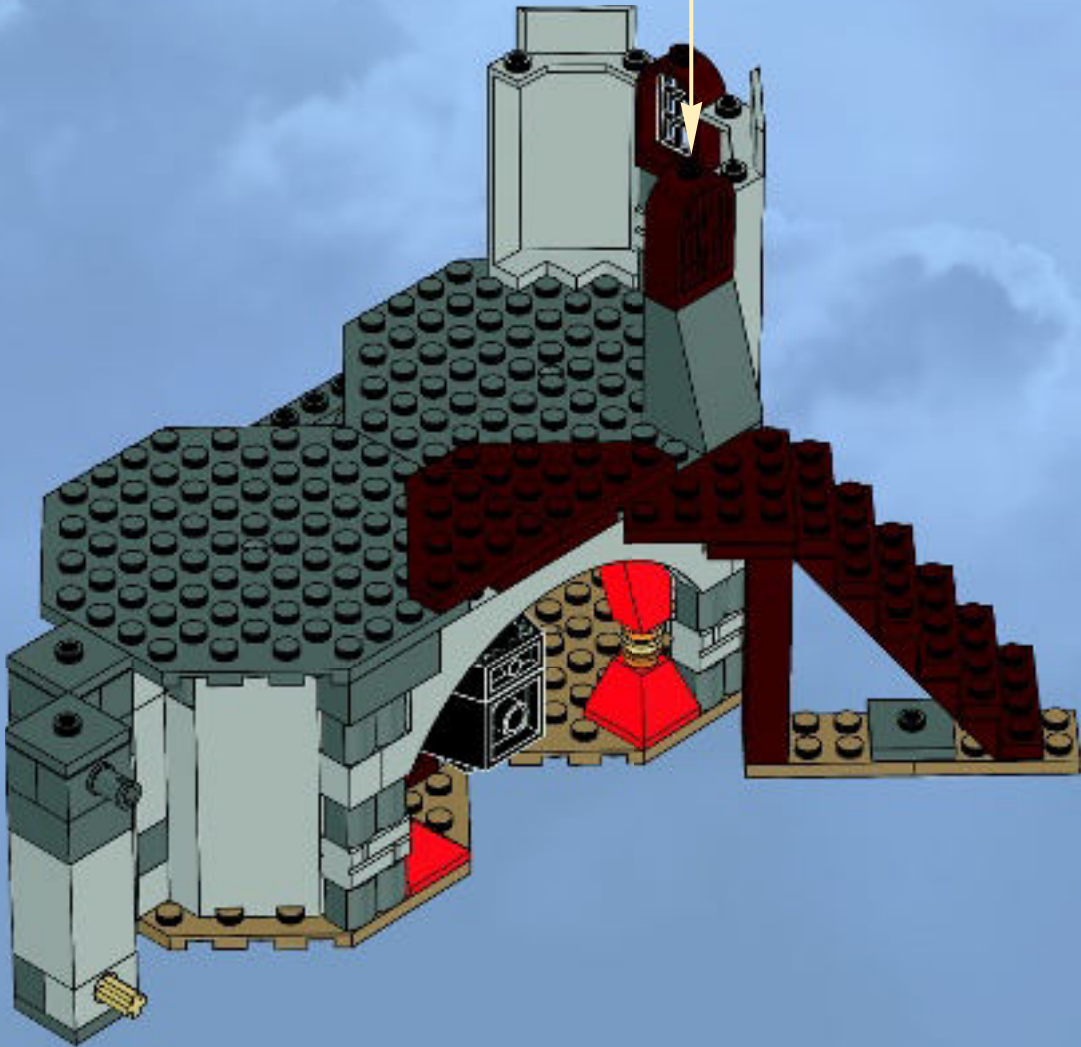
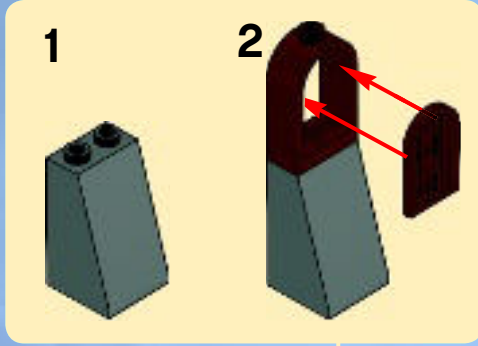

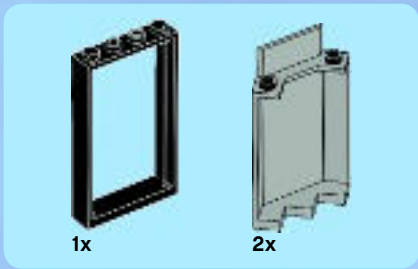

21

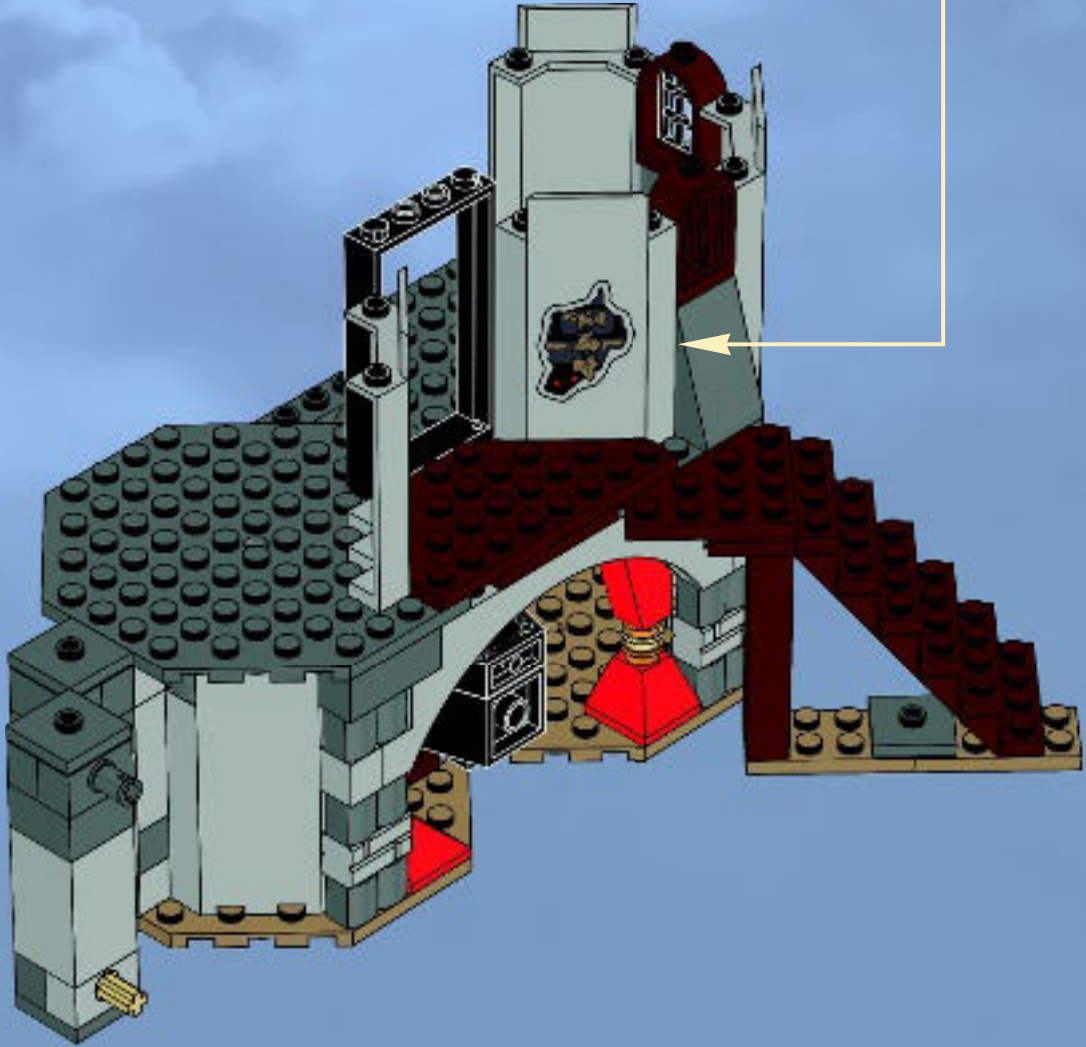
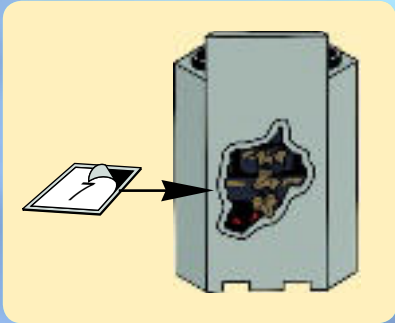





# 22

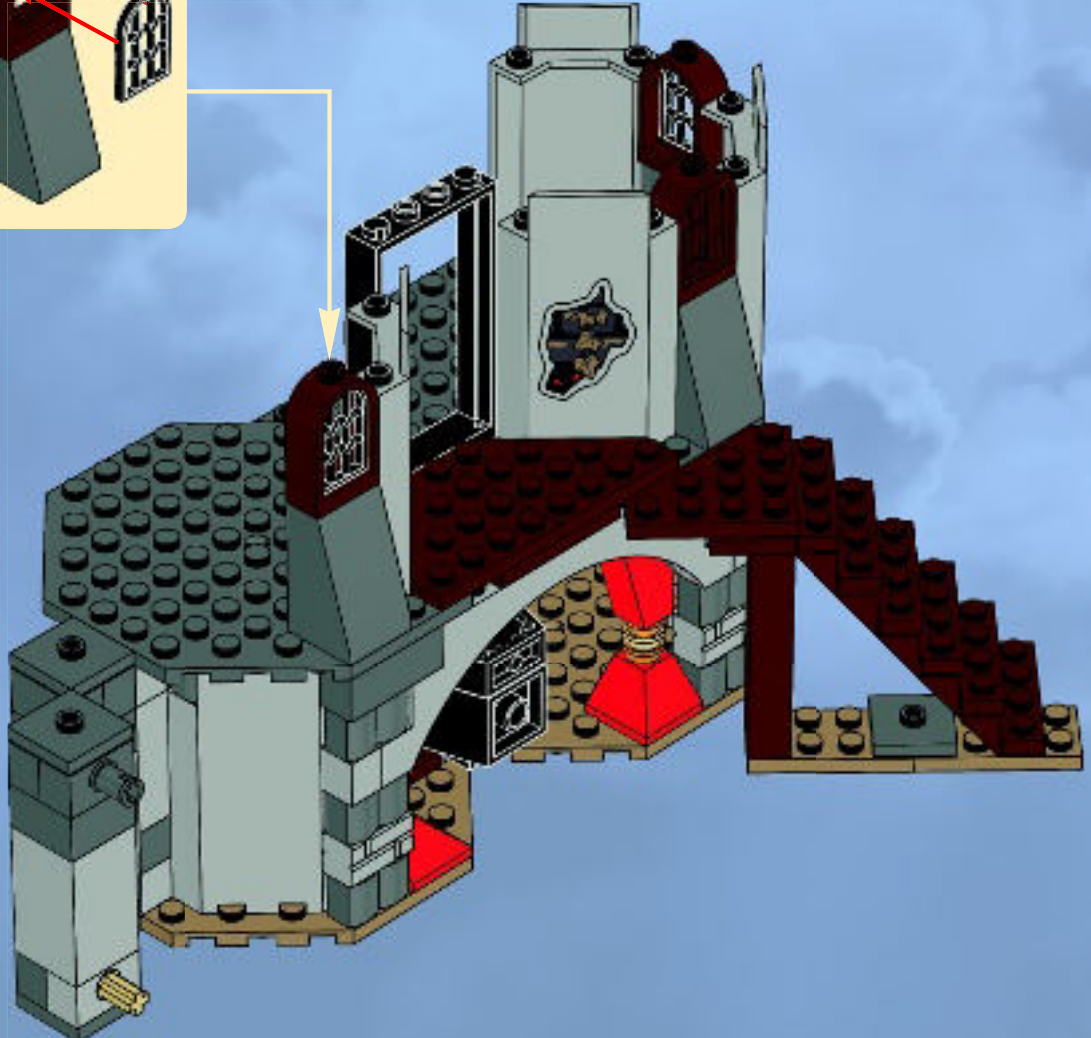
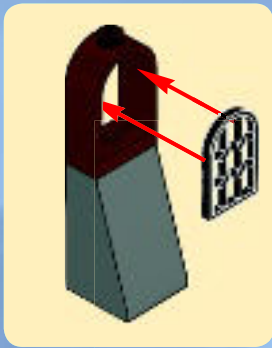

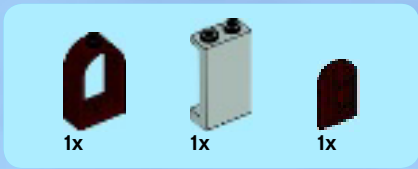

# 23

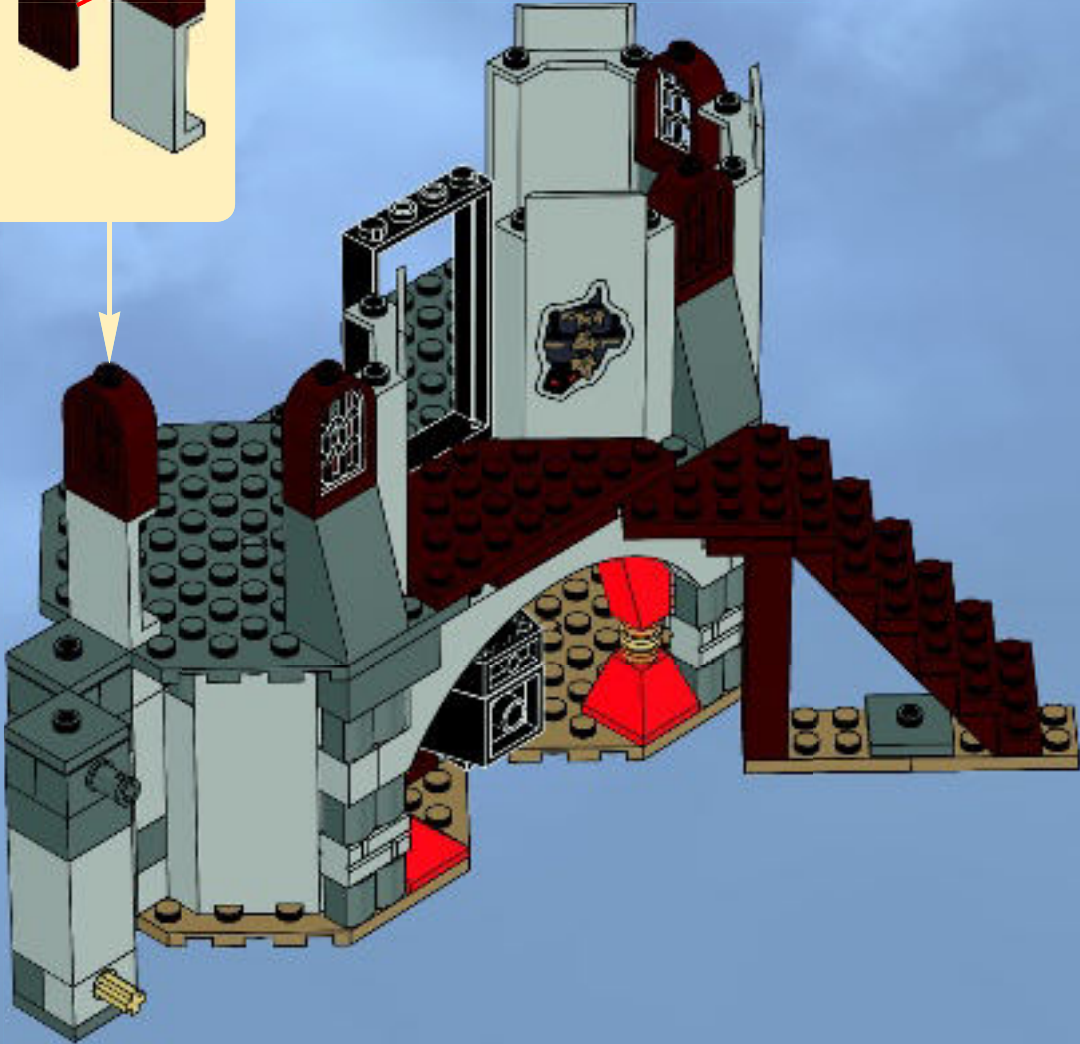
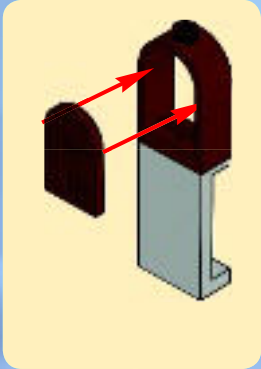

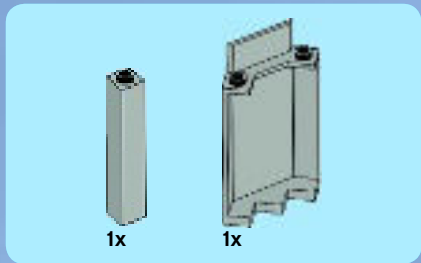

# 24

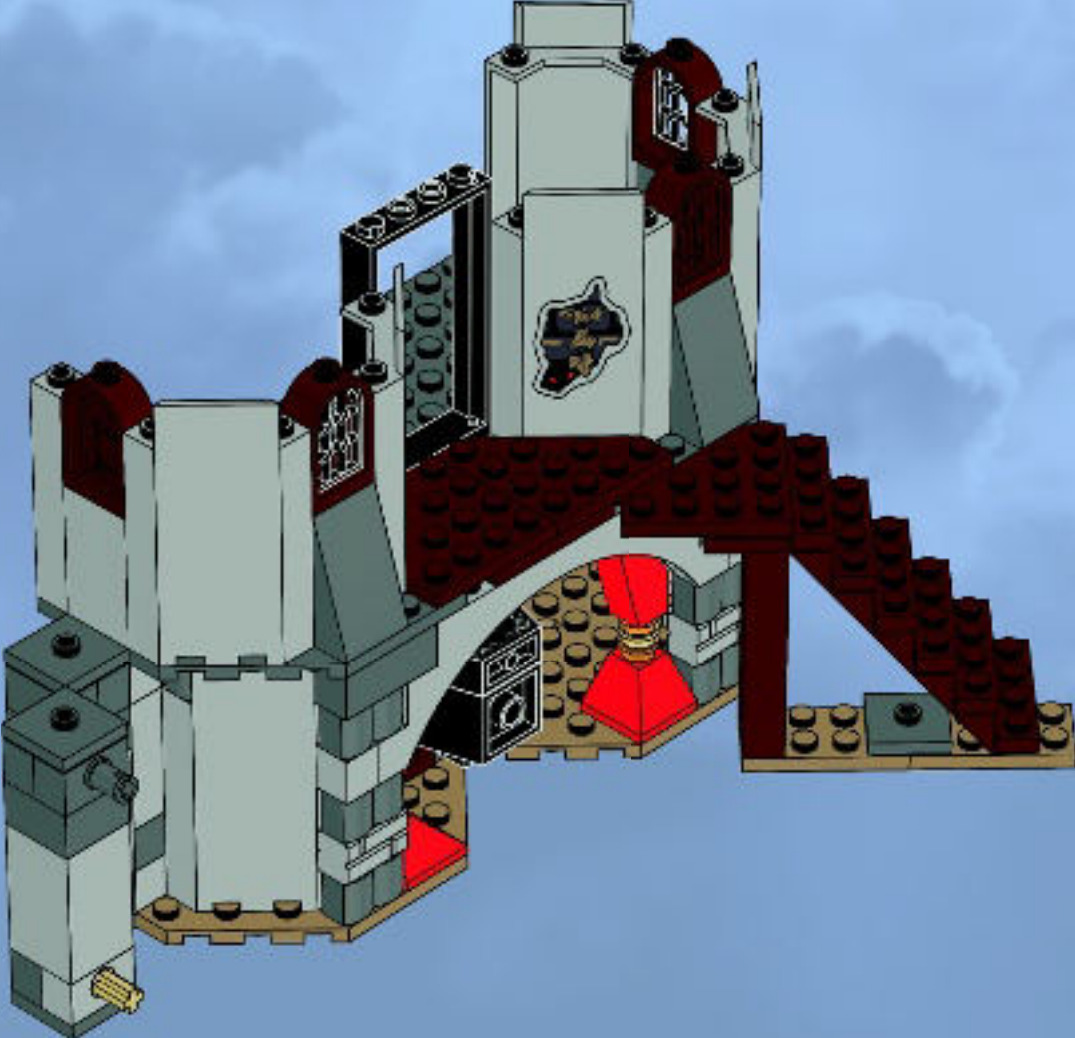



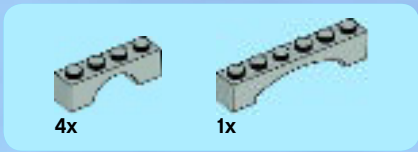

# 25

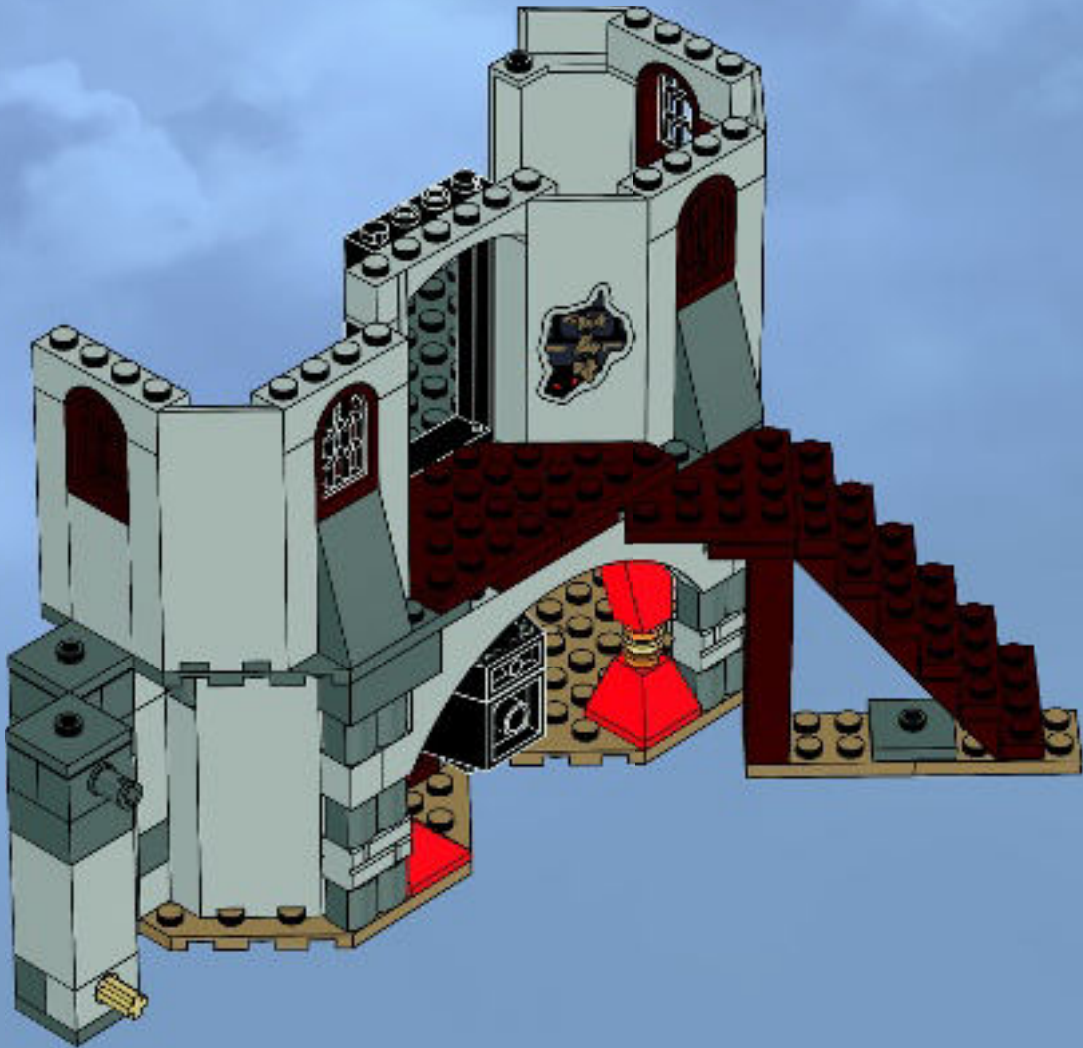



26

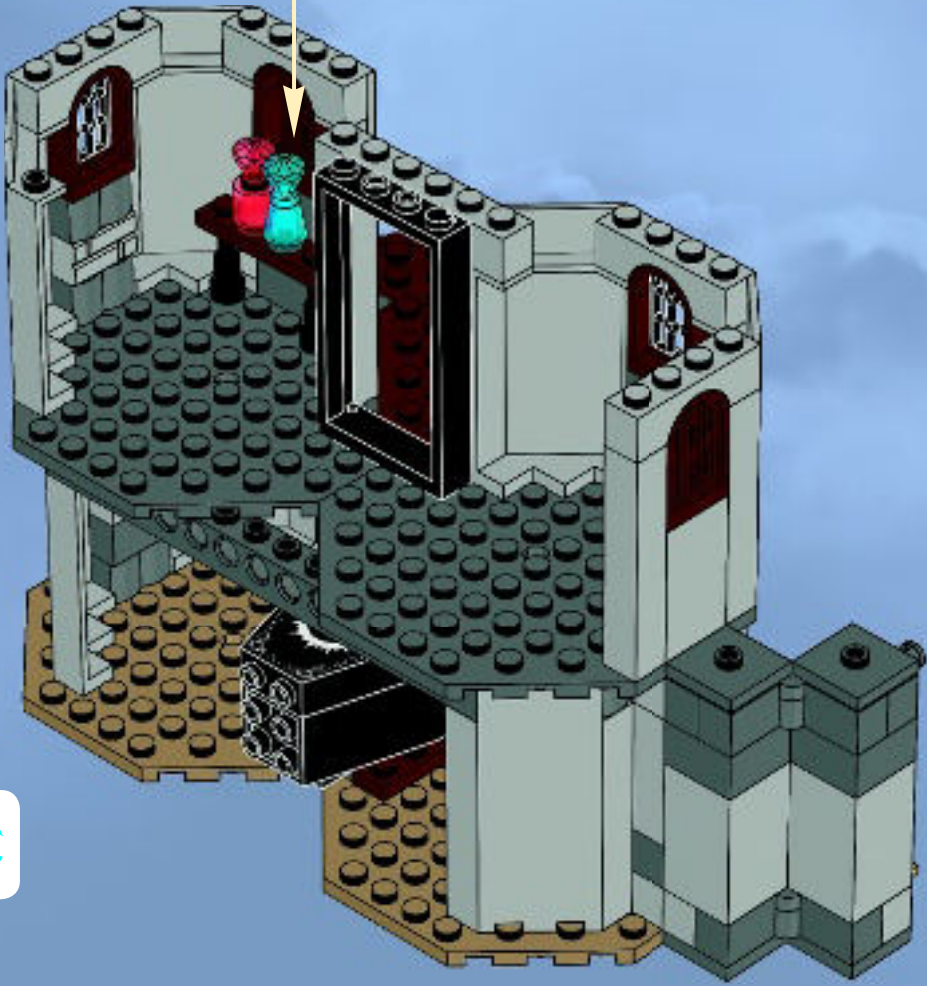
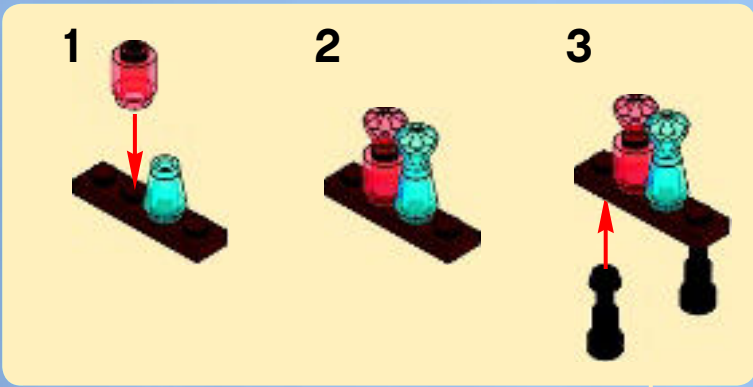

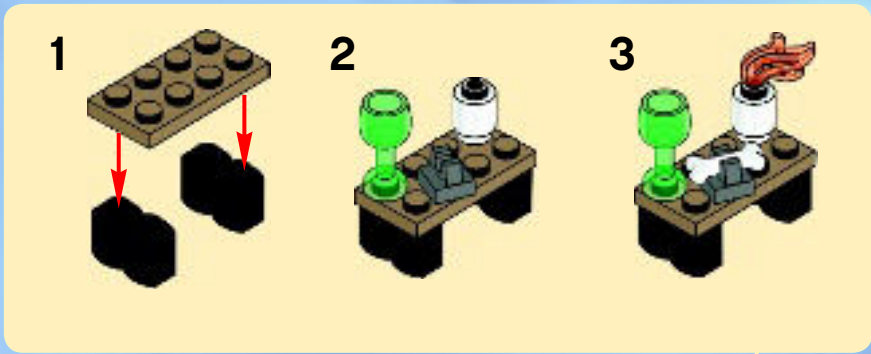

27







1



2

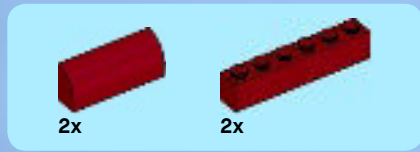

3

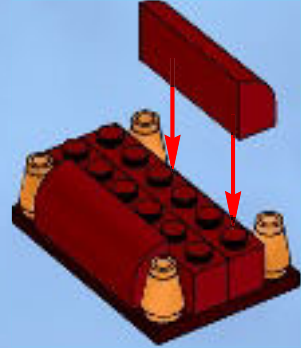

4

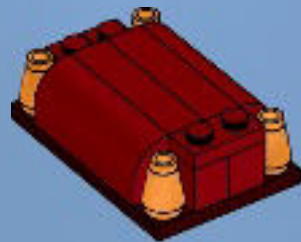



4x

5



2x



1x



1x

6

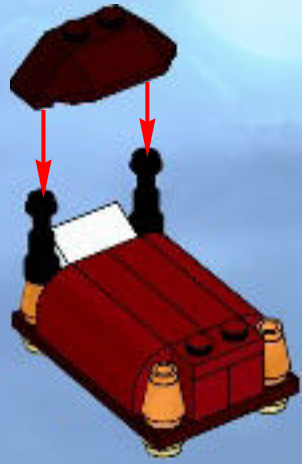

28

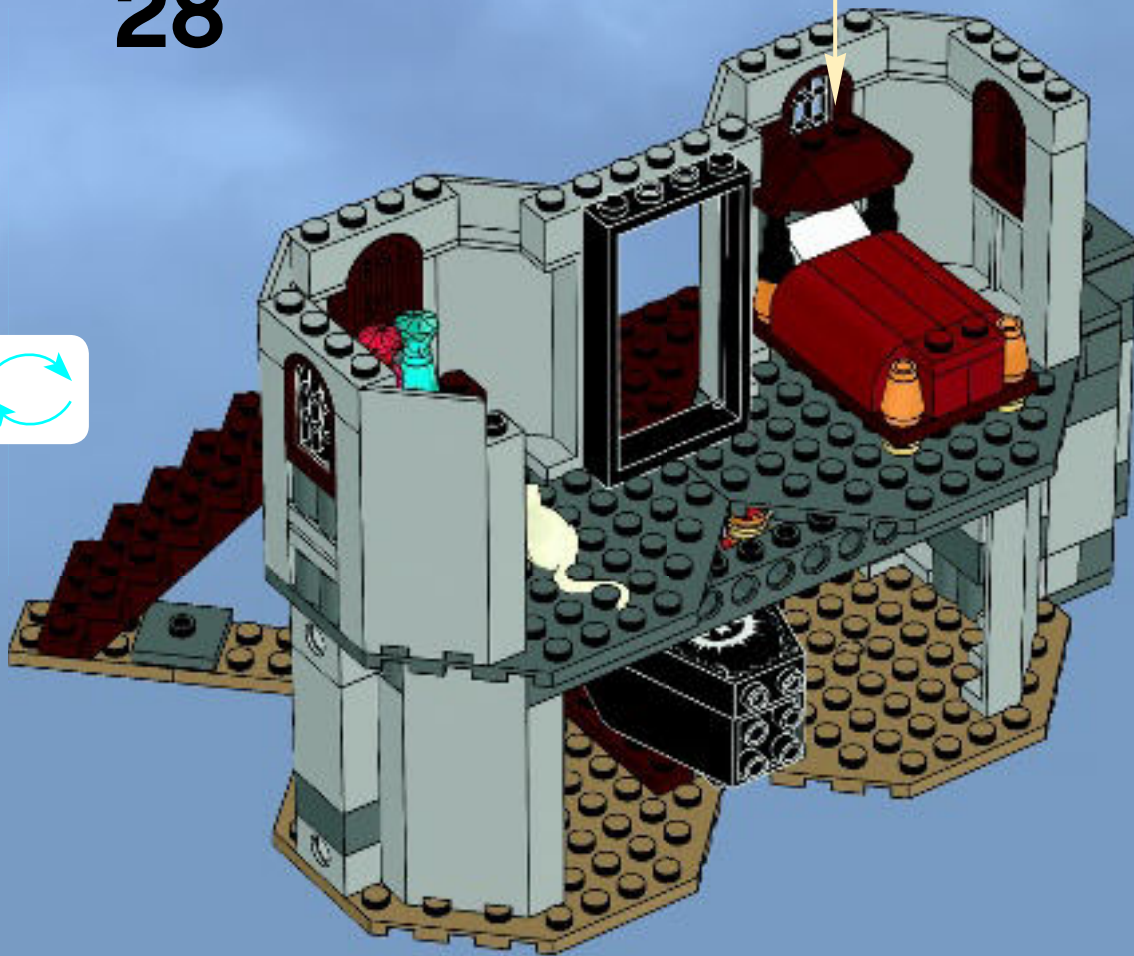

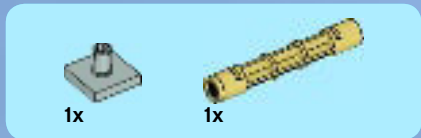

1



2

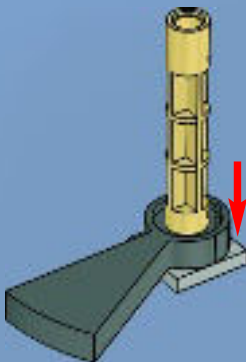

3

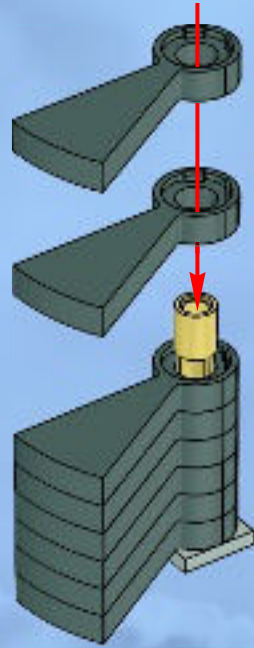

4

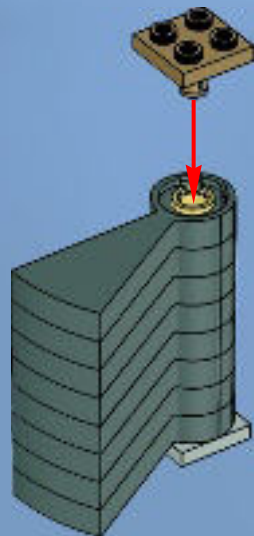



29

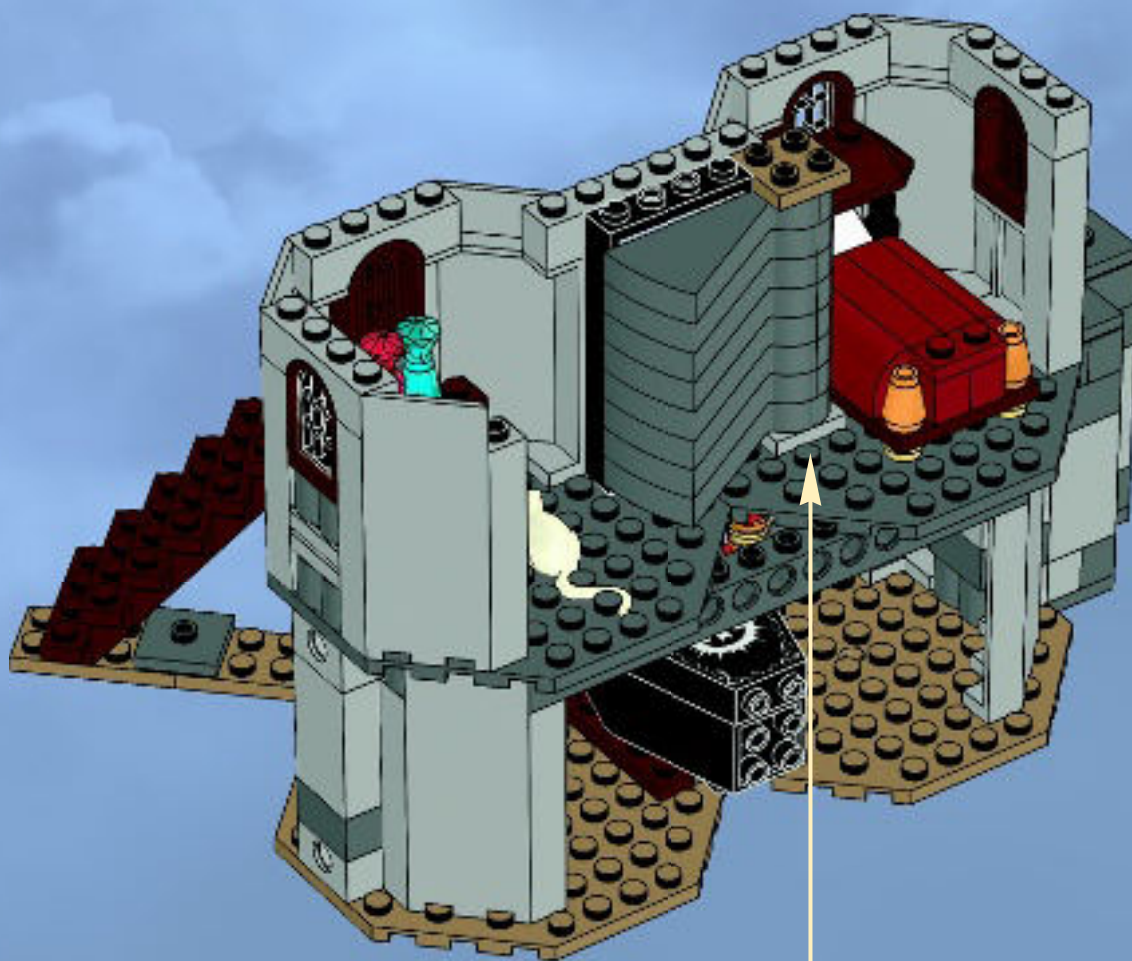



2x



1x

# 30

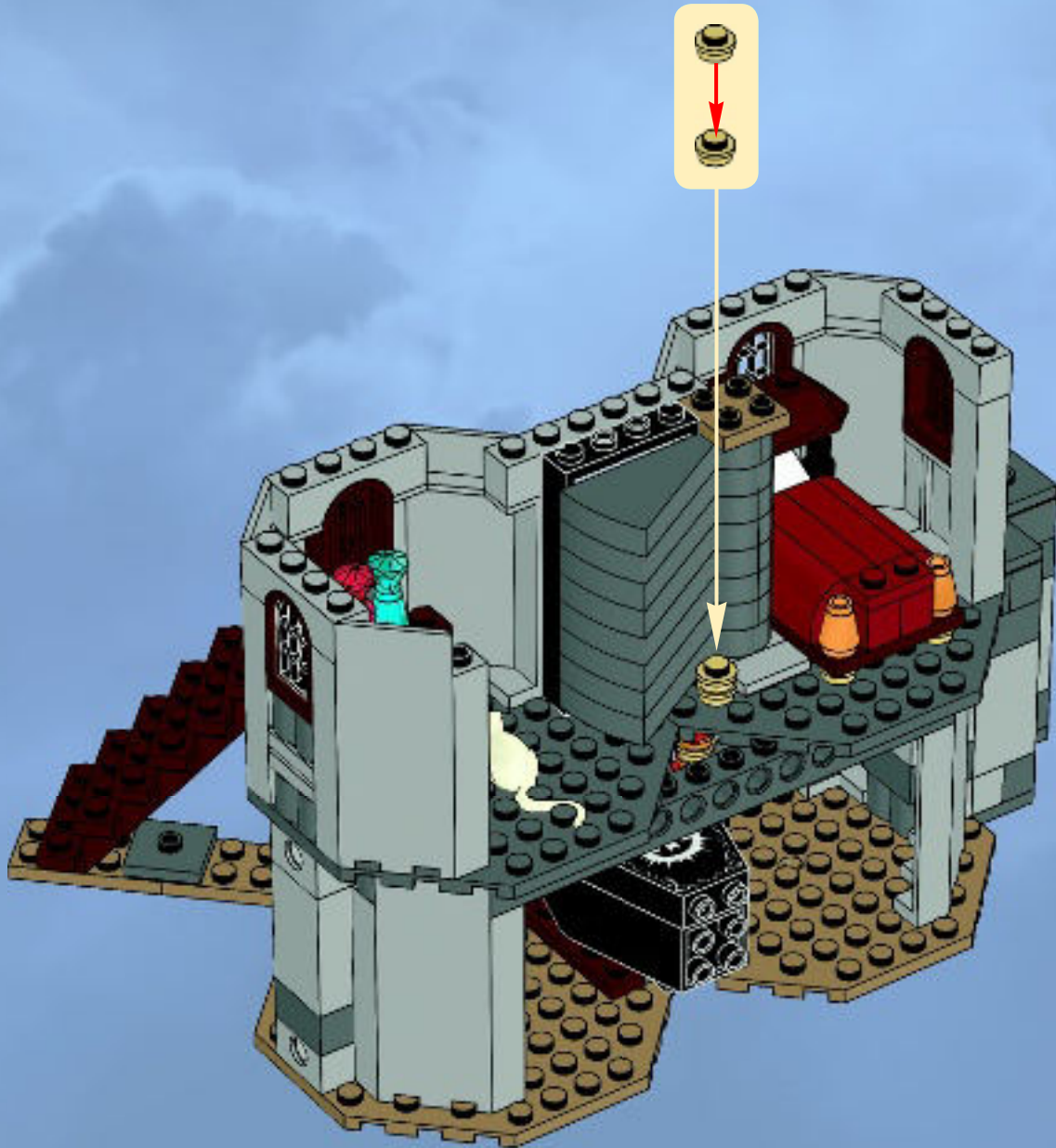

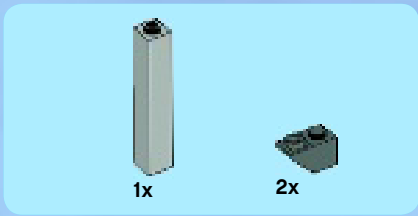

31

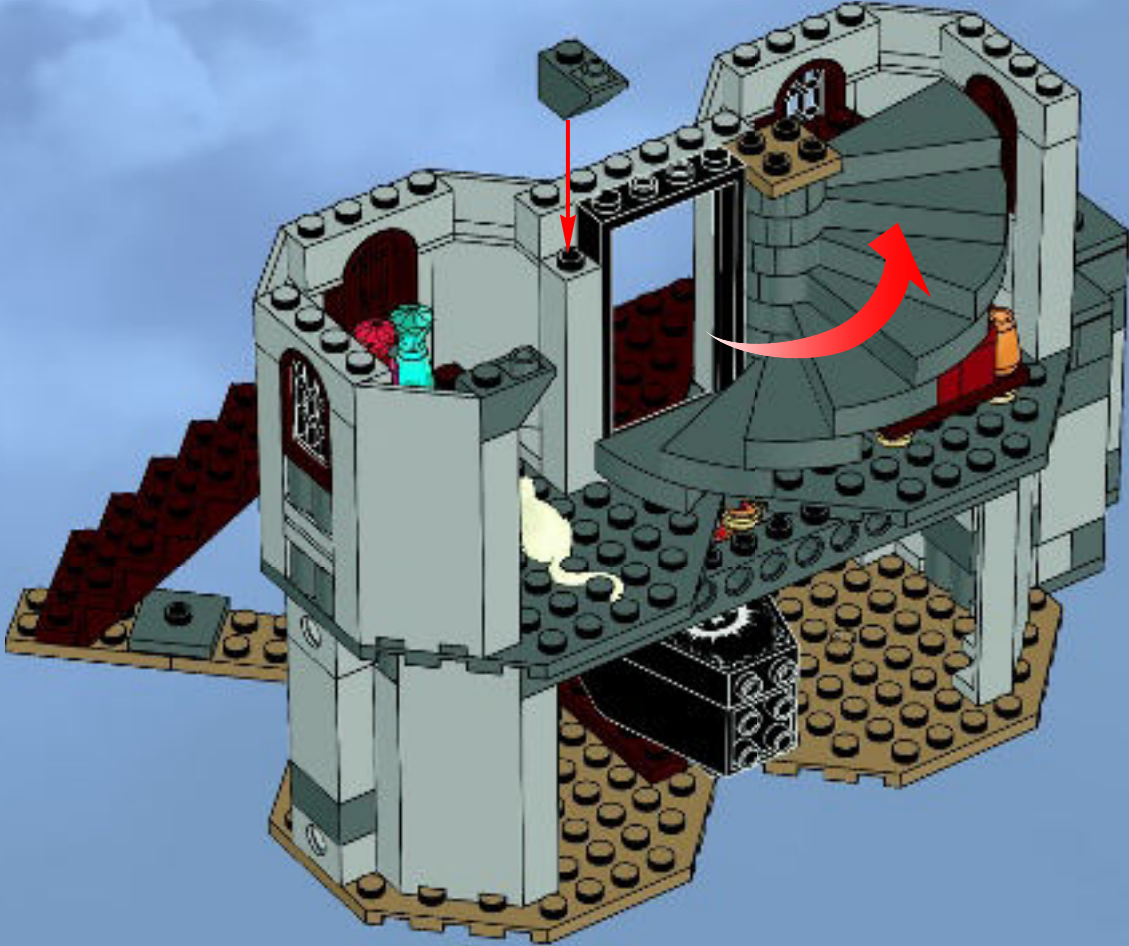





# 32

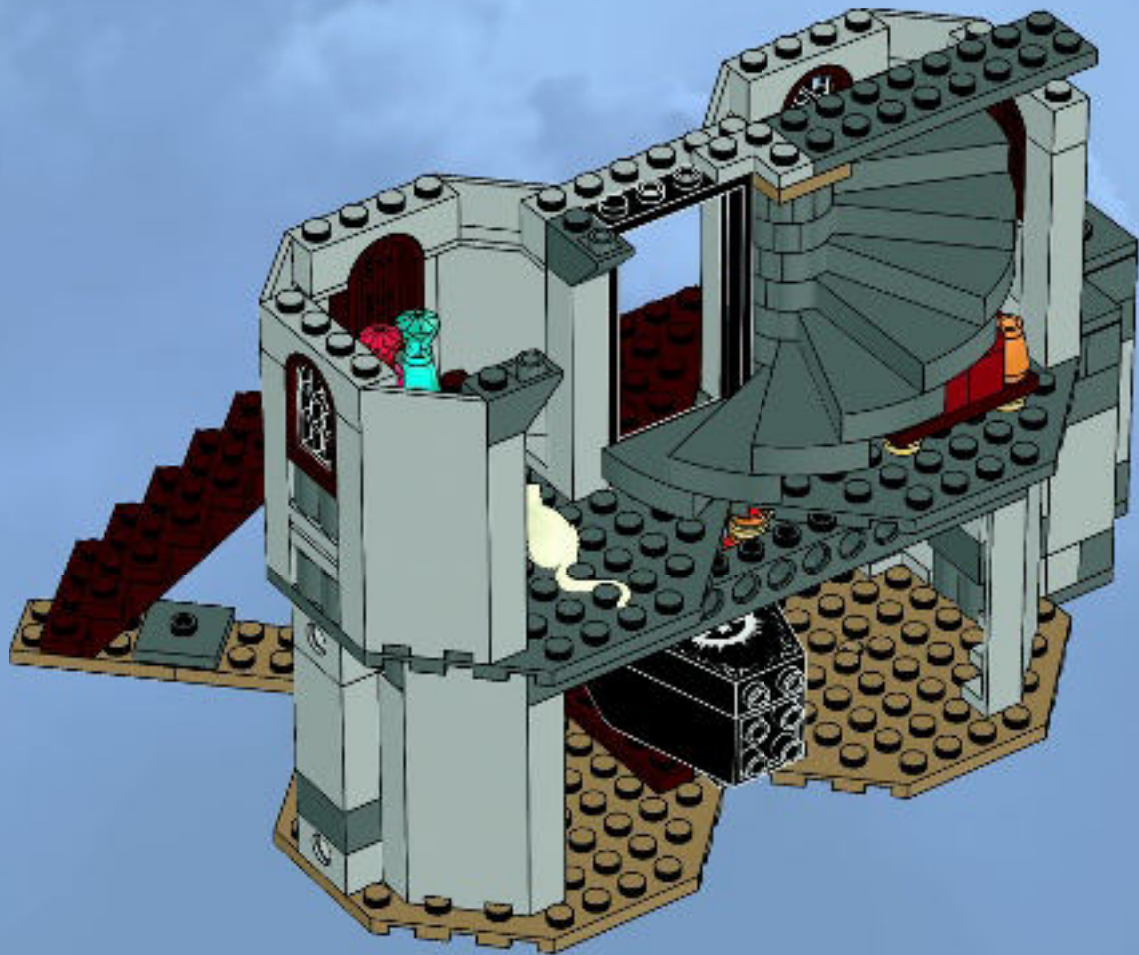



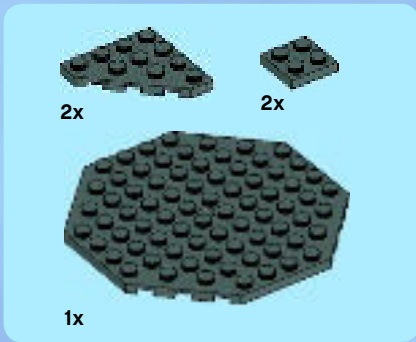

# 33

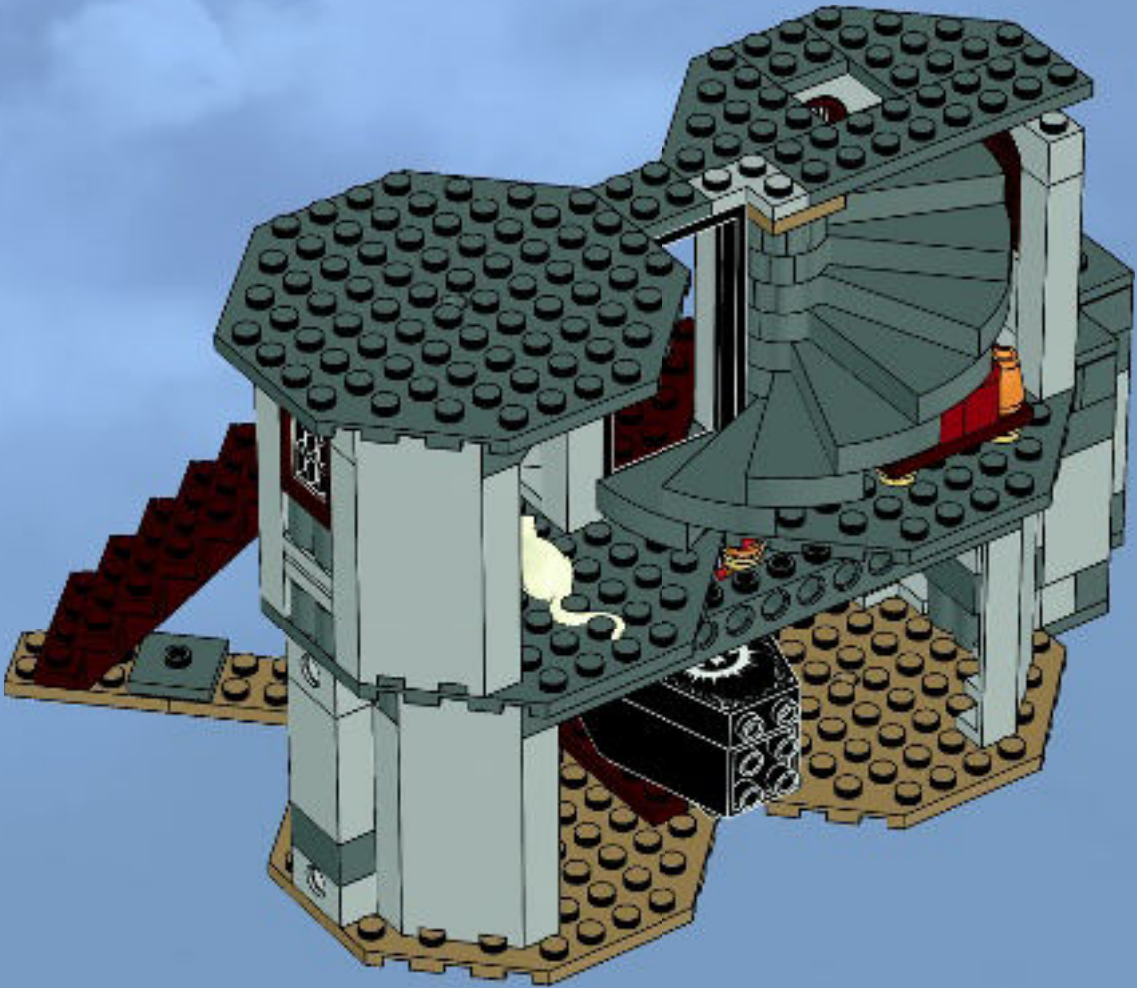



2x



2x



1x

# 34

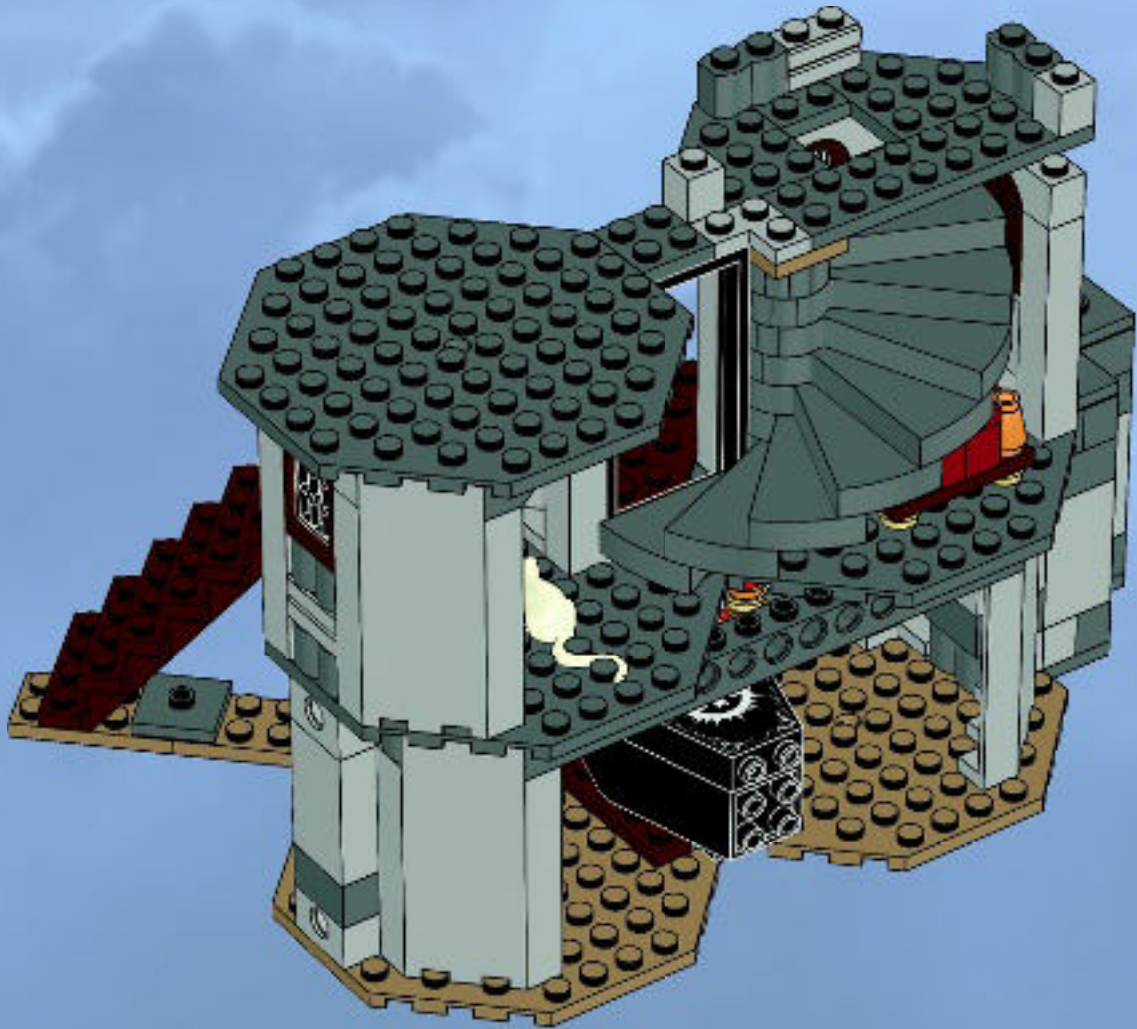



2x



1x

# 35

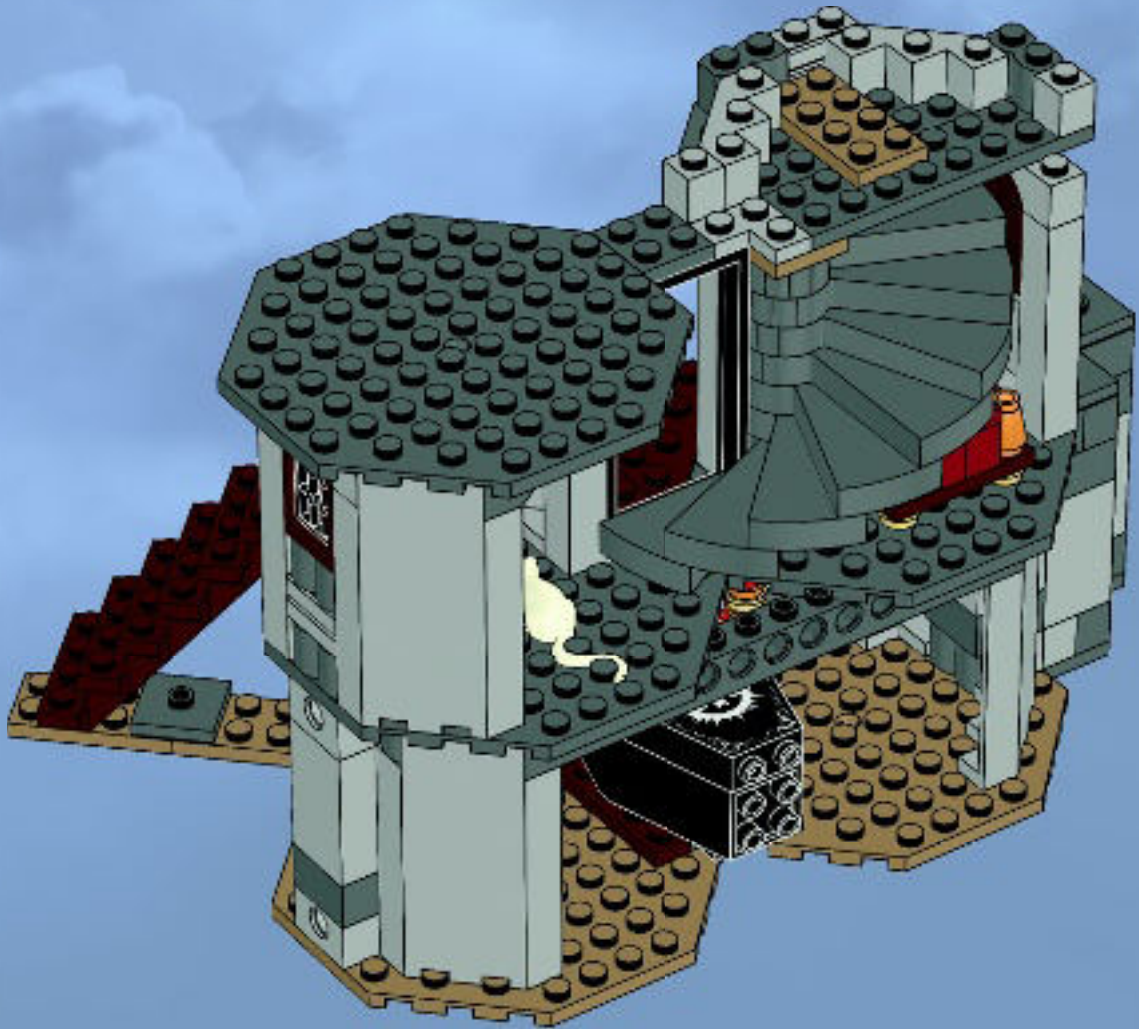





2x



4x

# 36

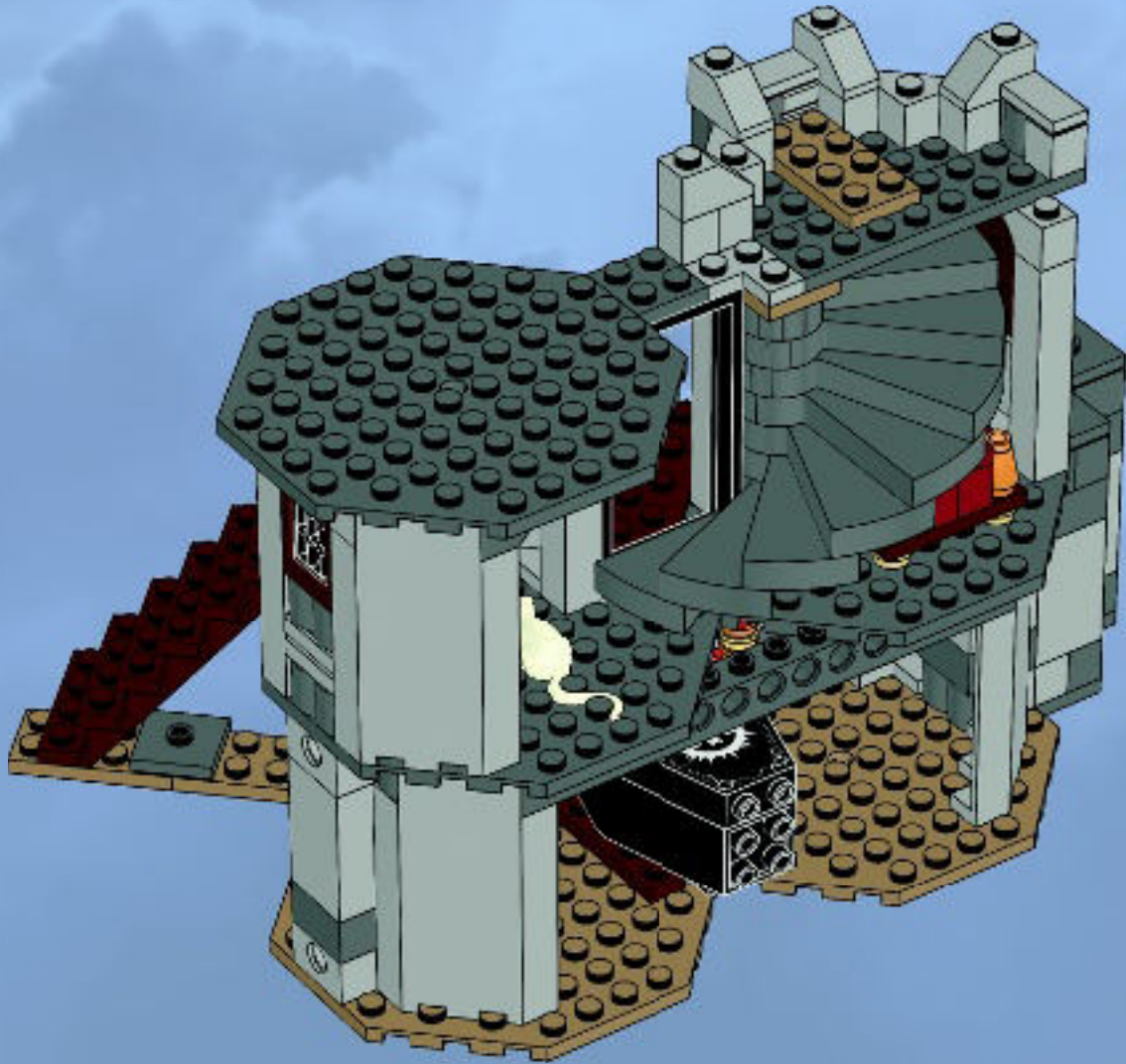



37

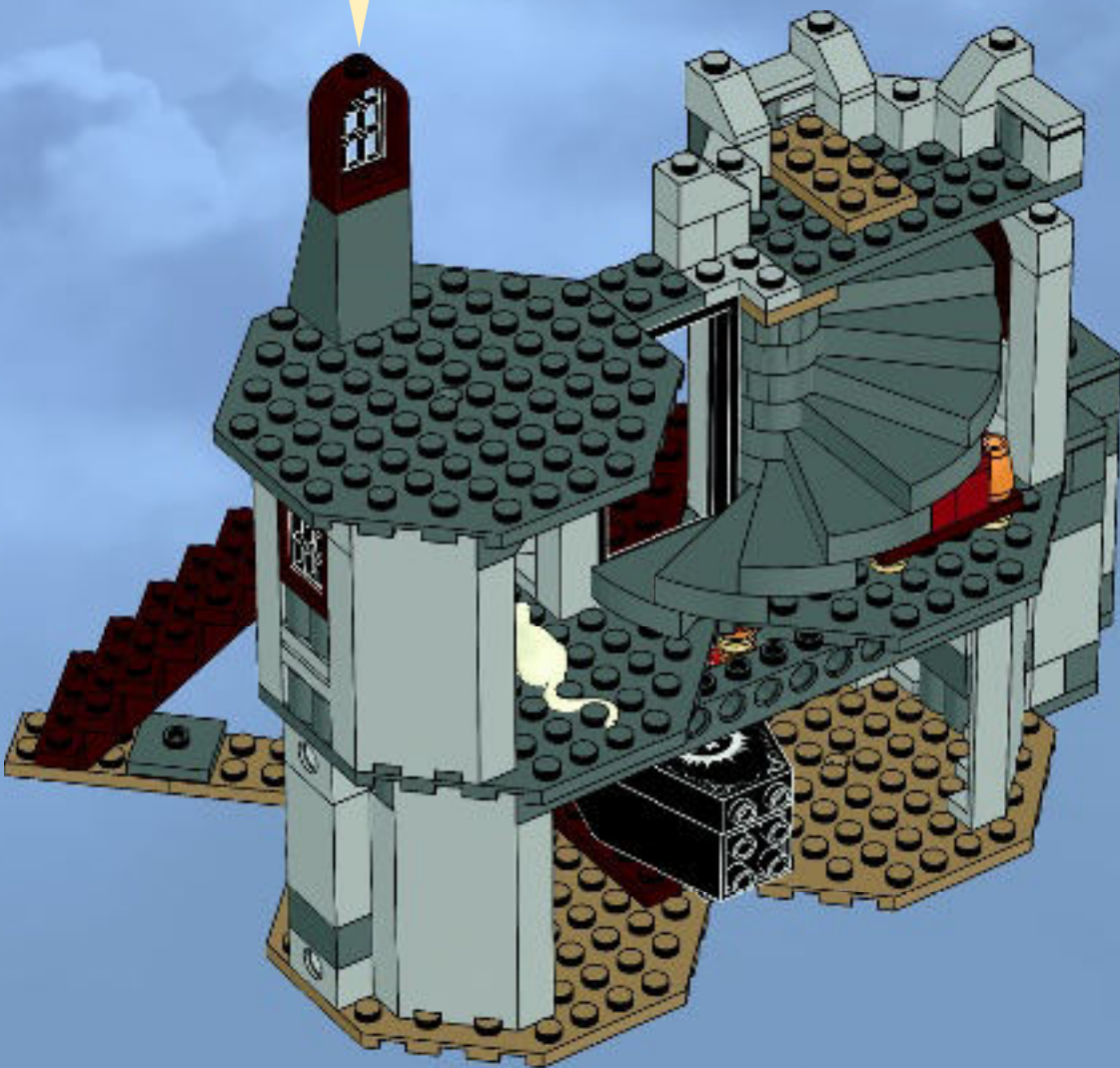
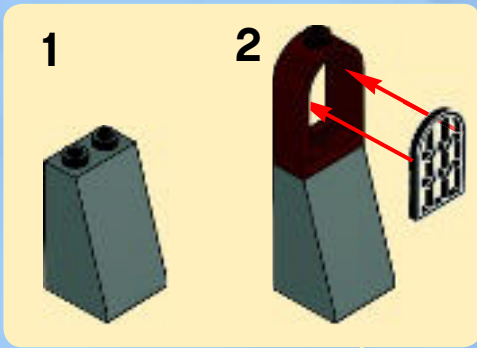



# 38

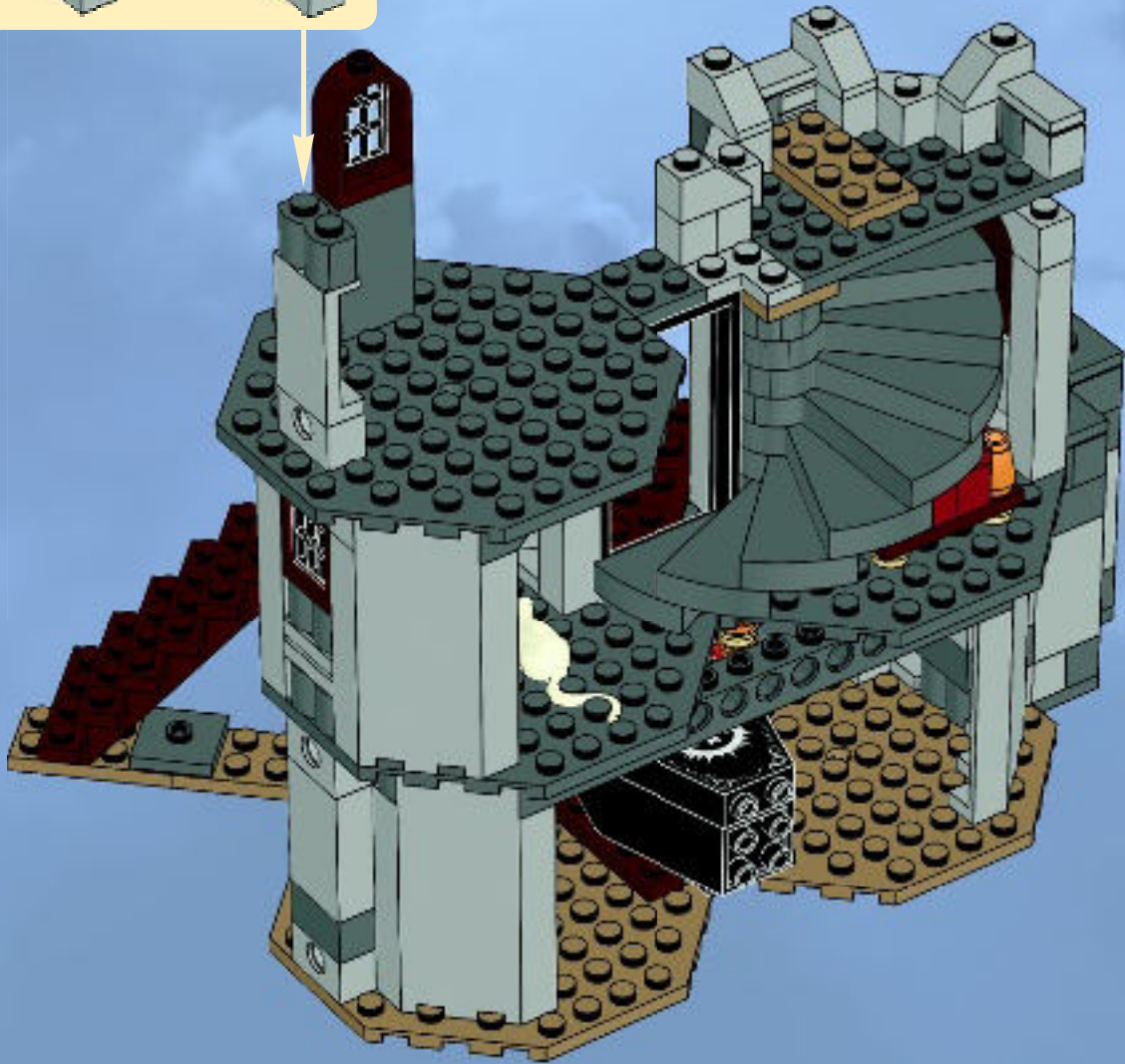
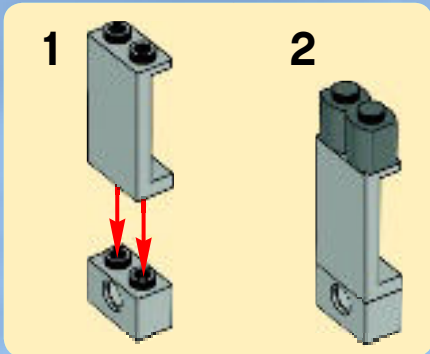



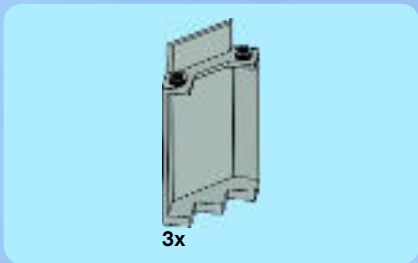

39

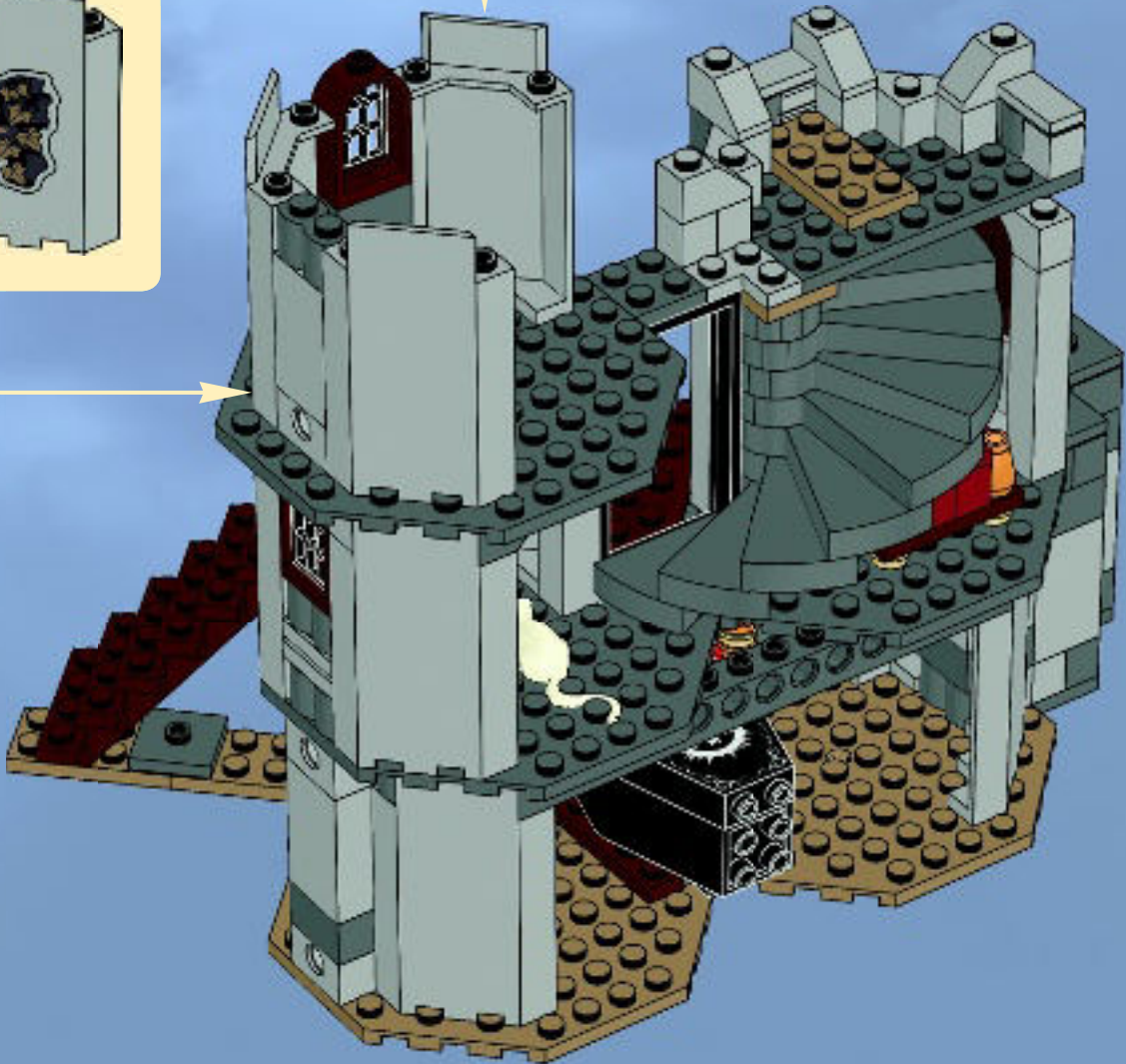
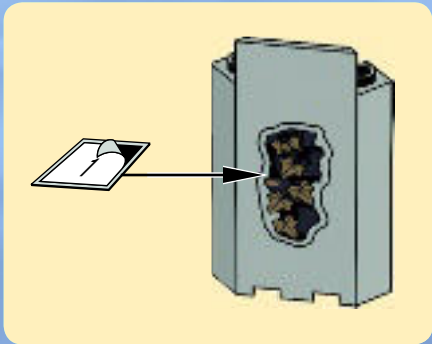
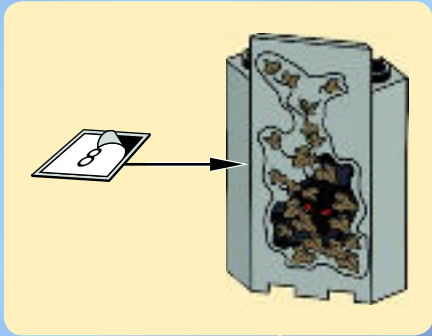



2x



1x



1x

# 40

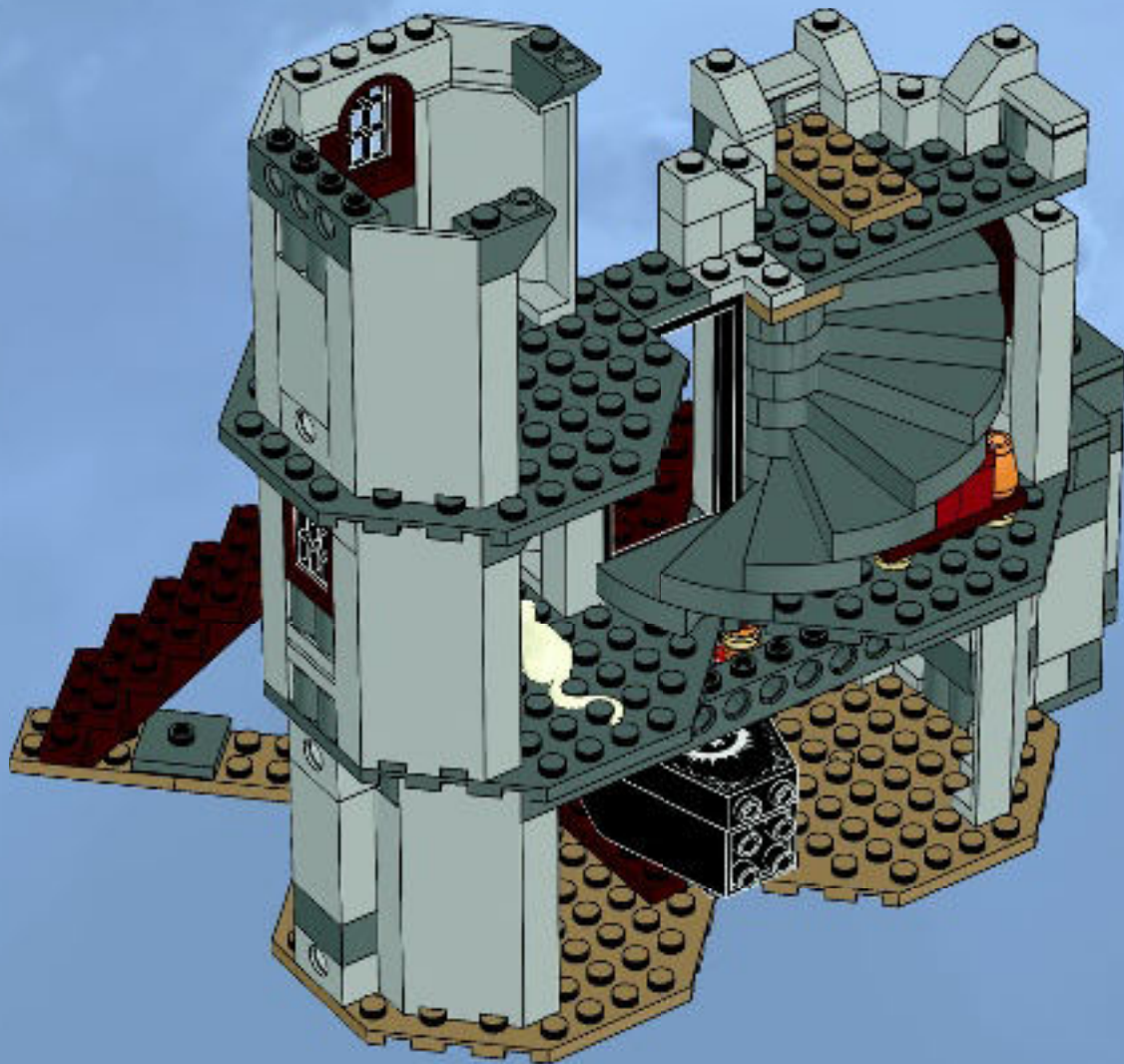

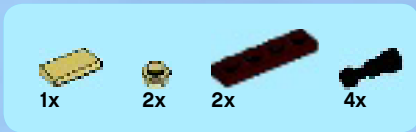

41

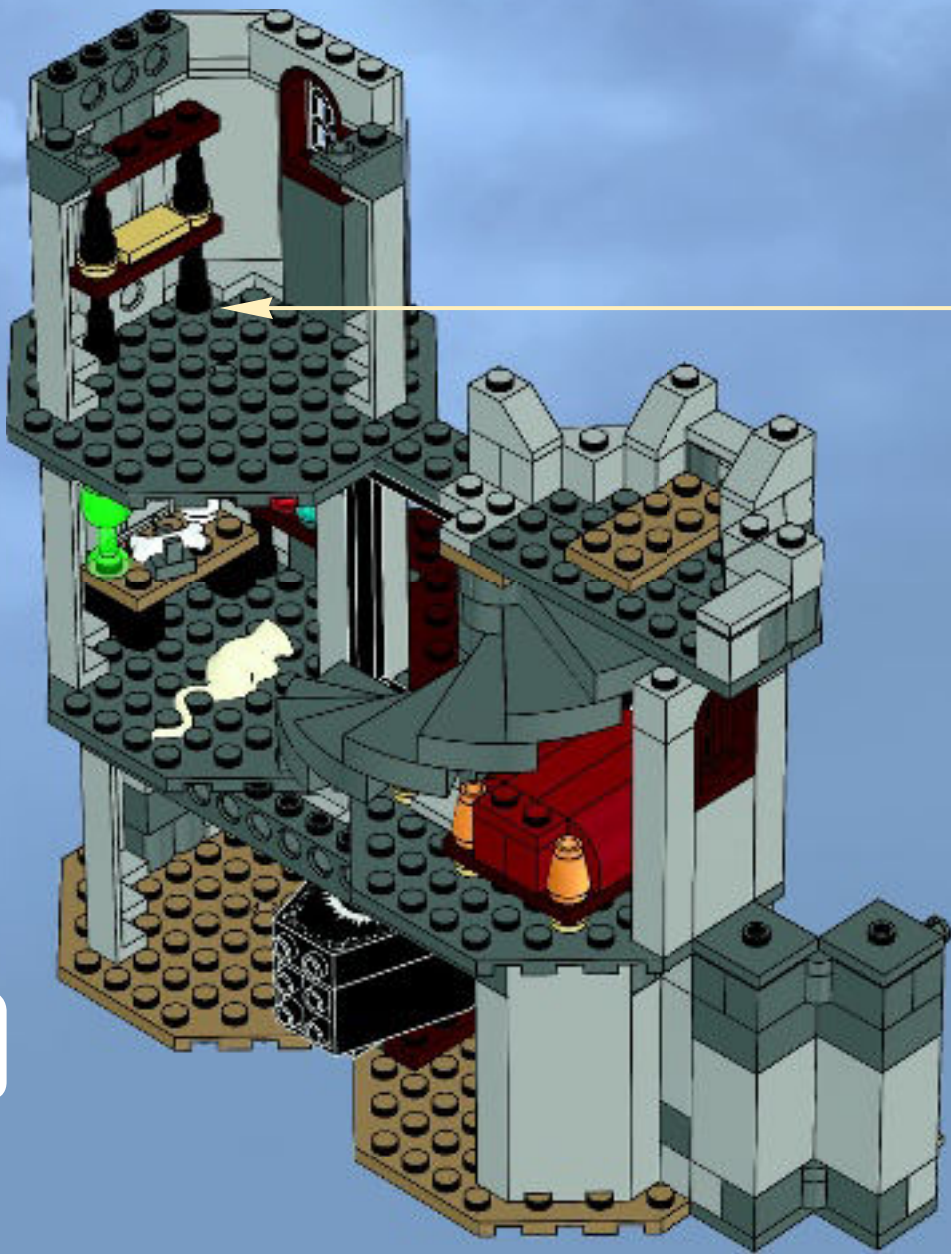
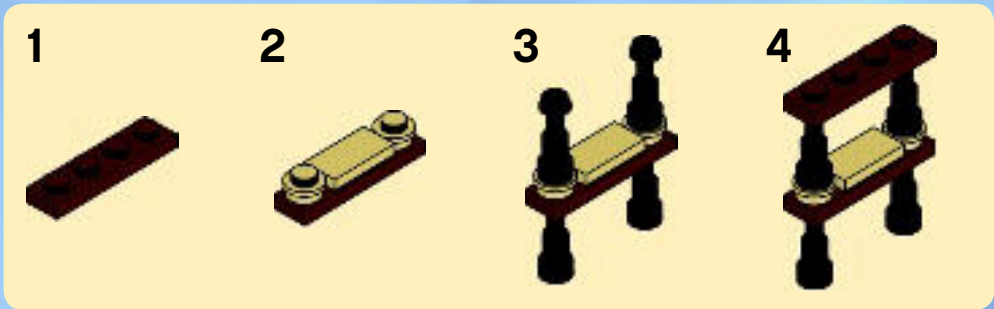





42

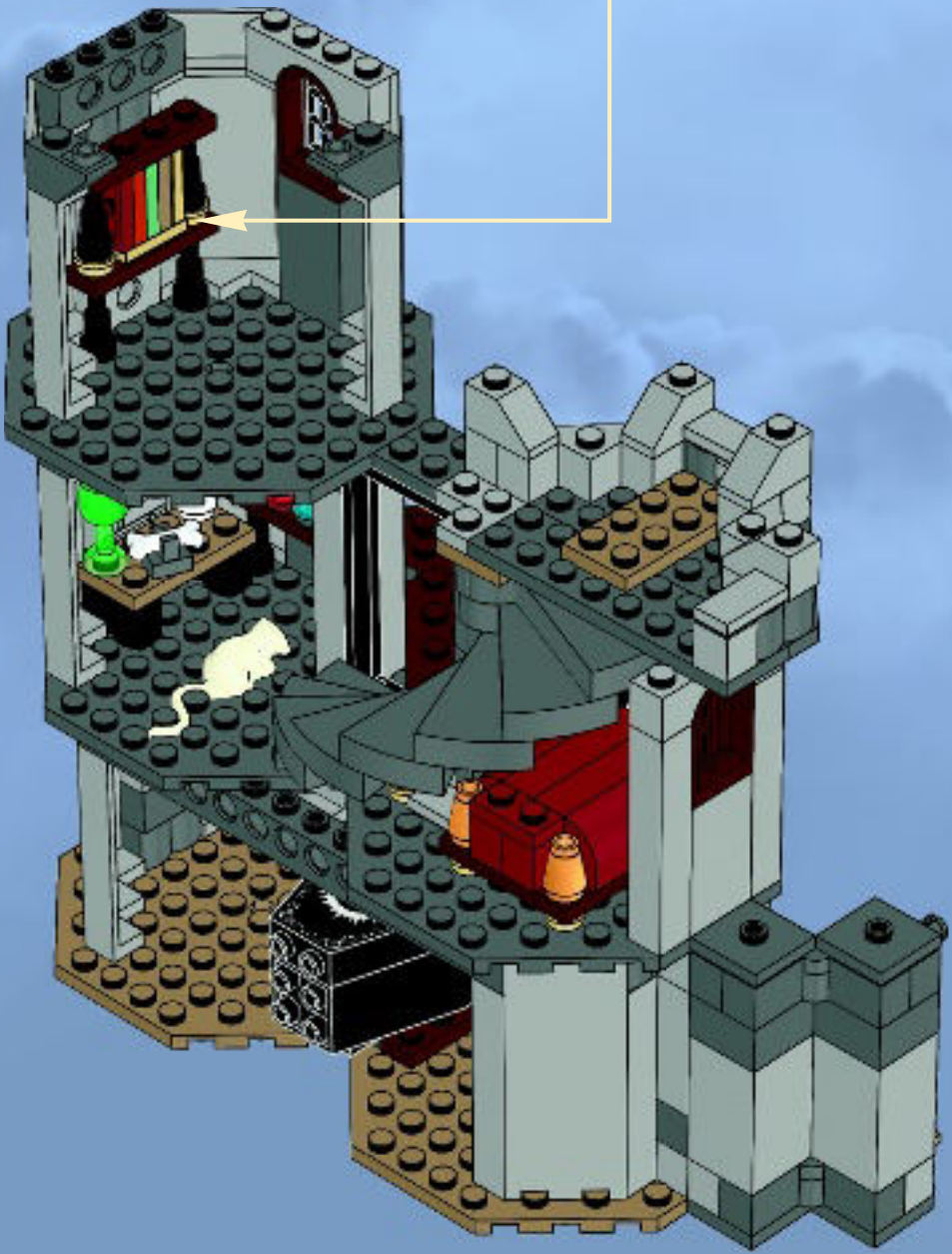
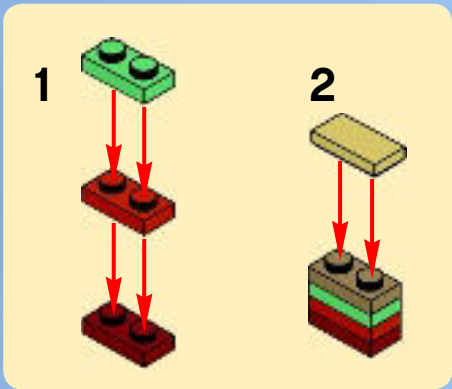



# 43

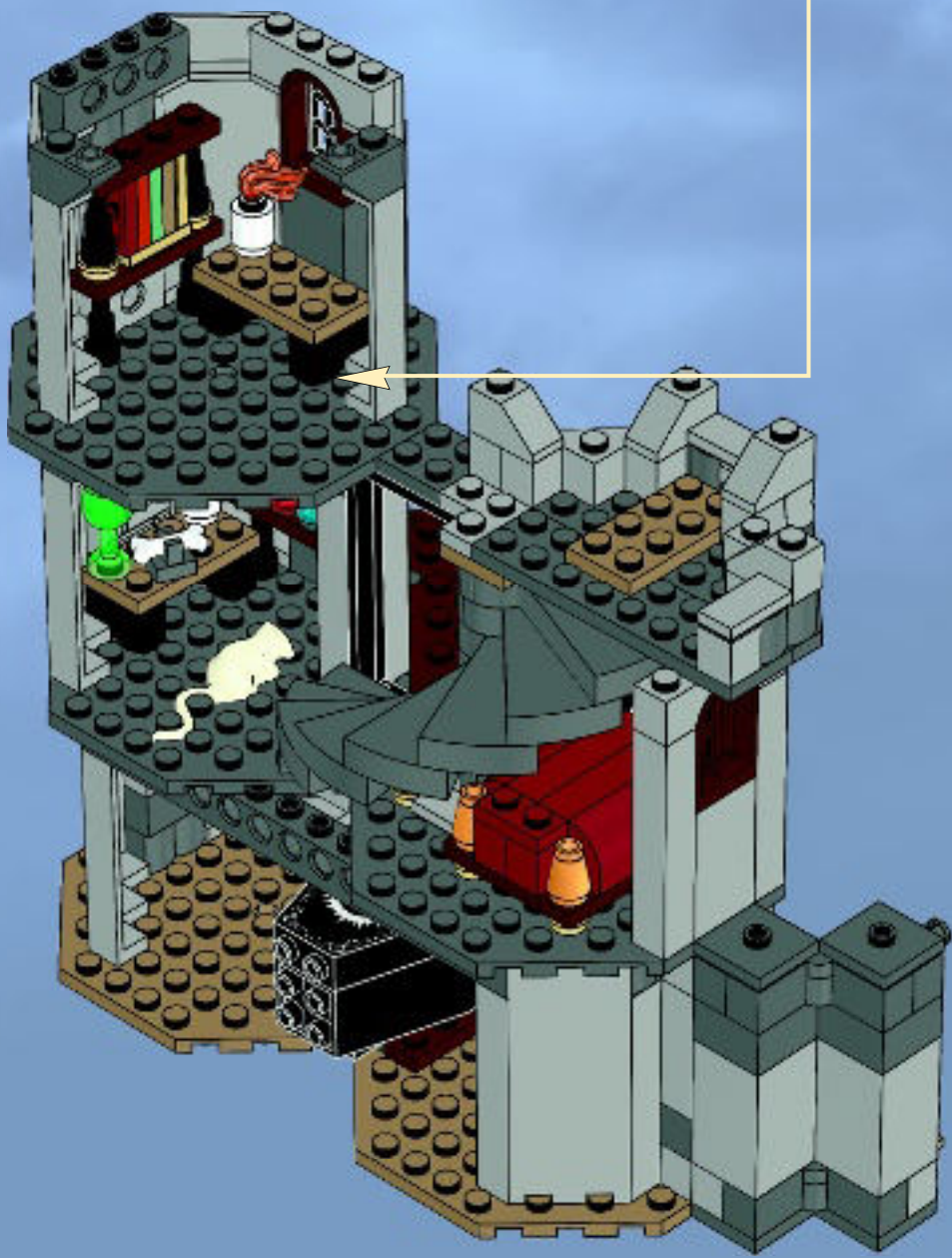
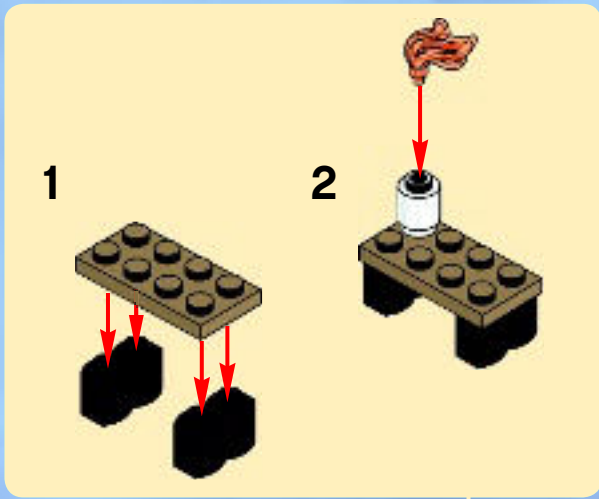

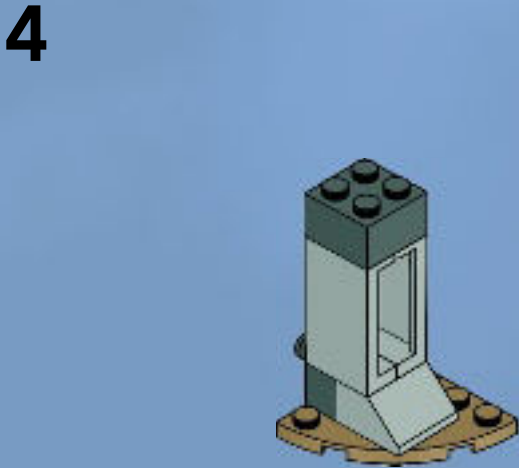
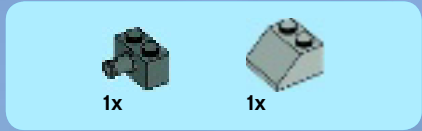
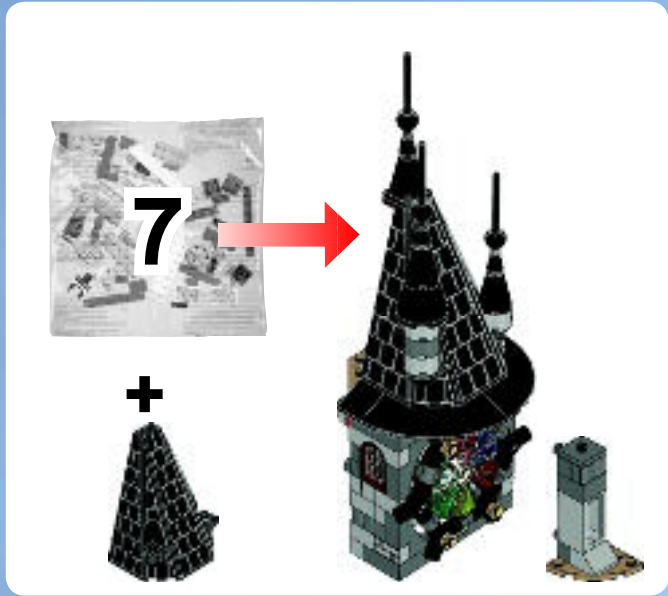





1x



1x

5

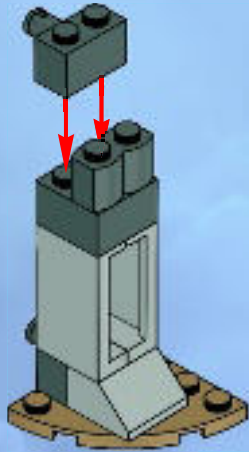

1x

6



44

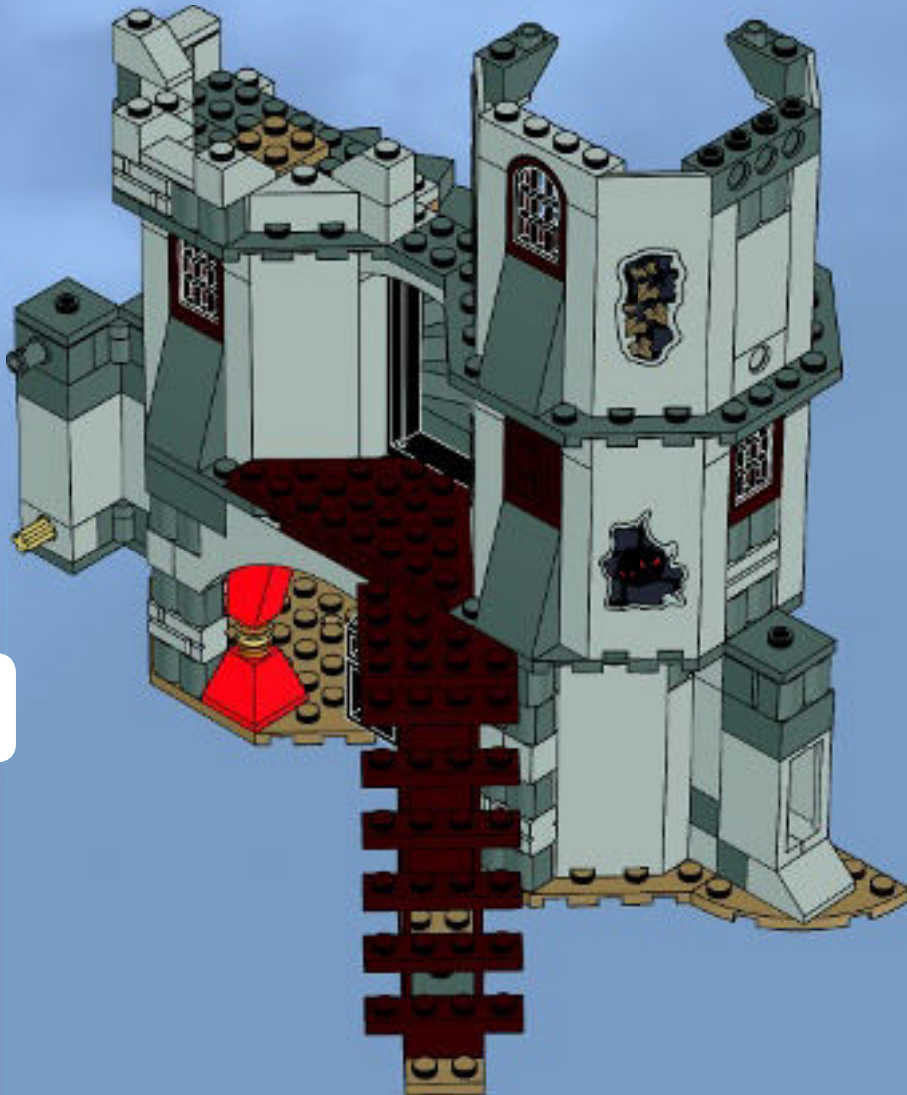



45

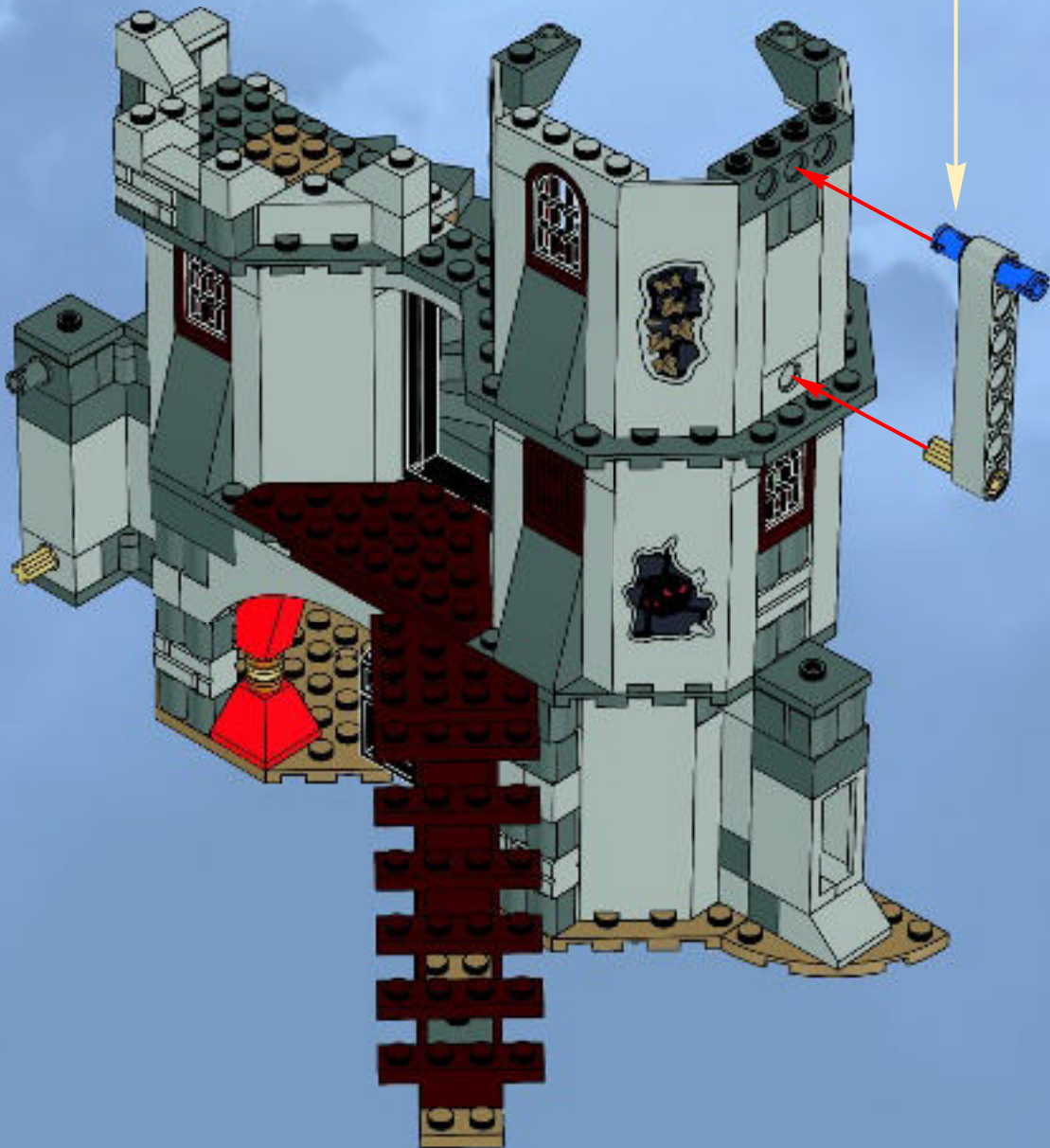
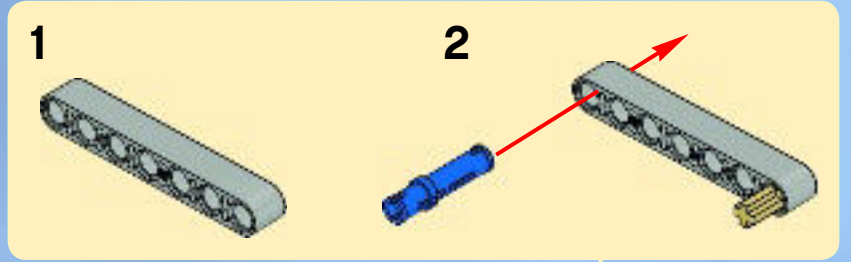



1x

# 46

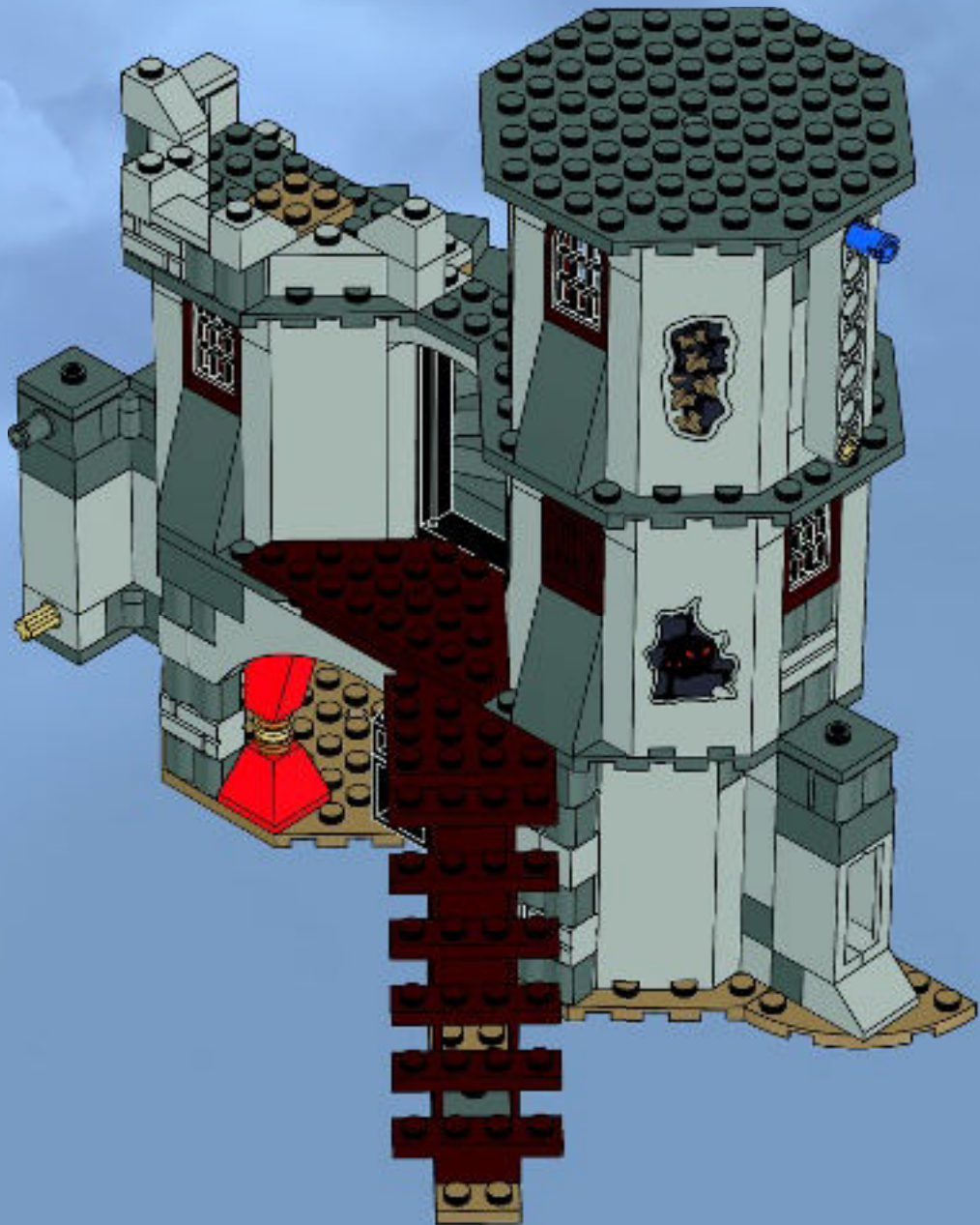



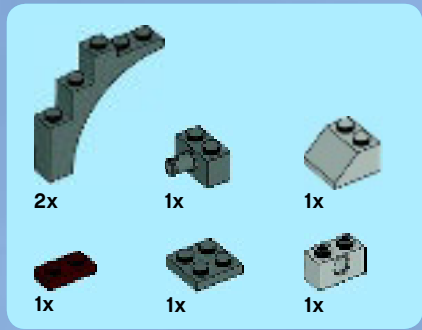

# 47

1

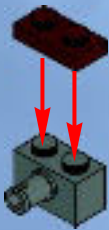

2

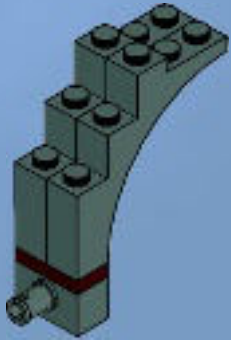

3

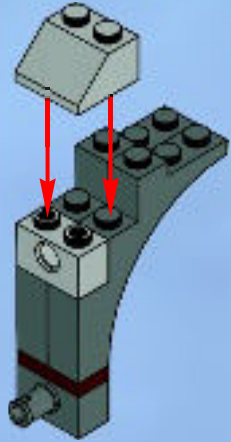

4

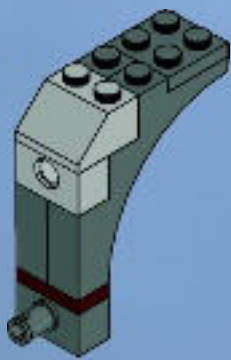

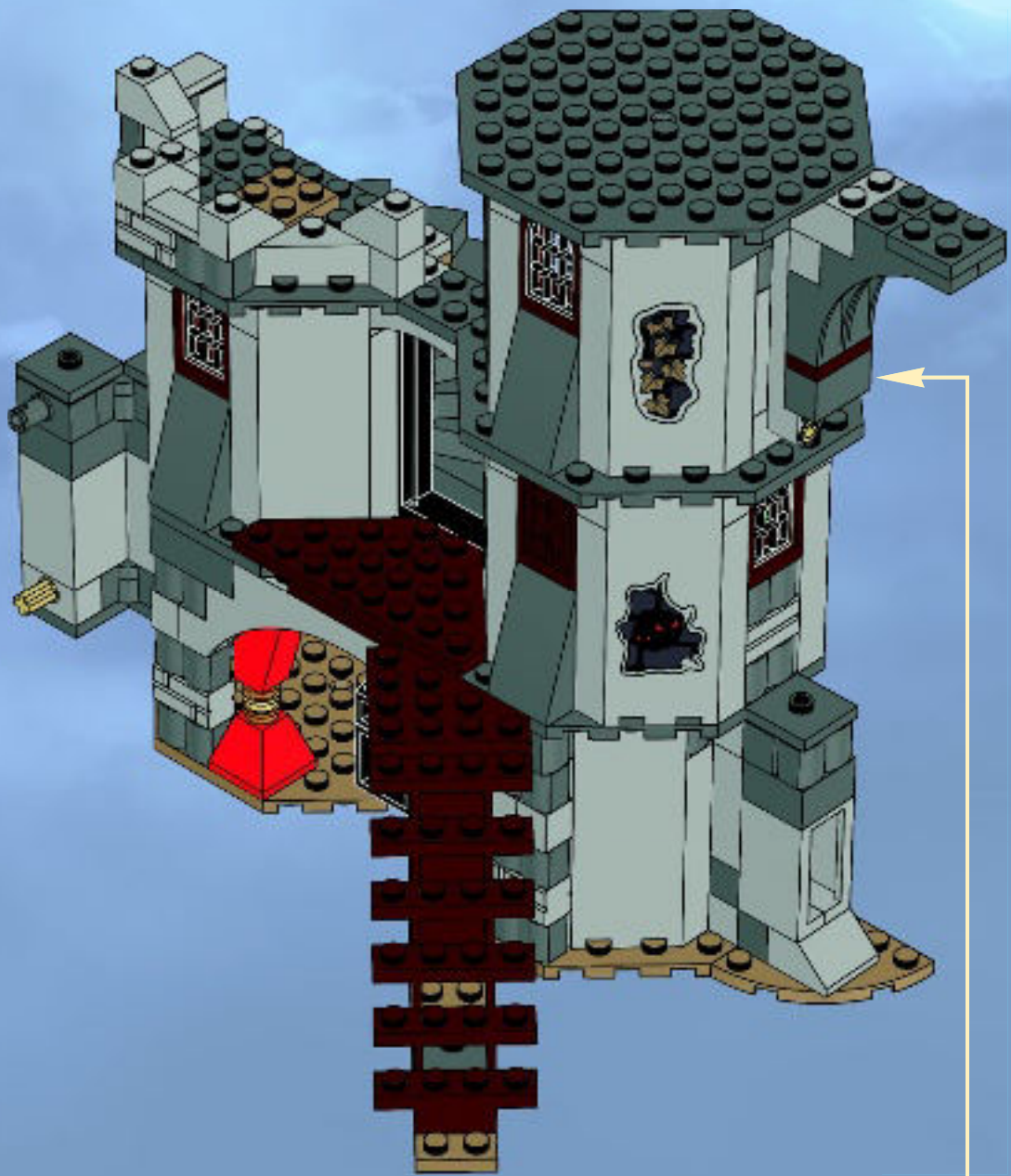



1

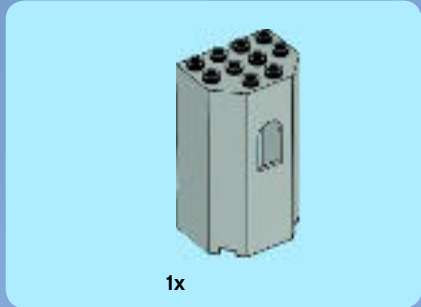
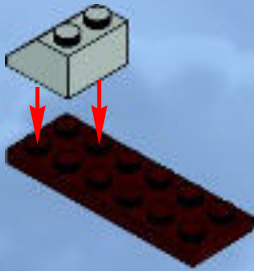

2



3

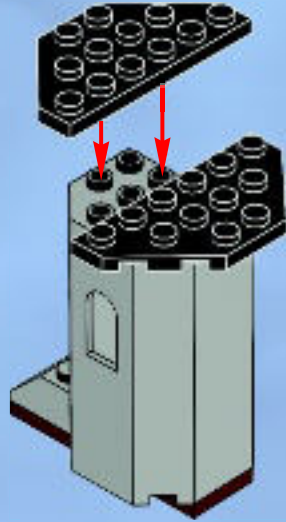

4

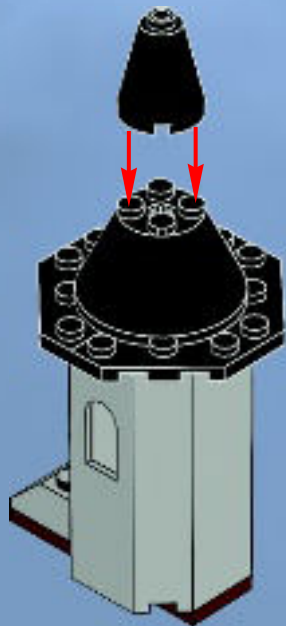





1x



1x

5



48

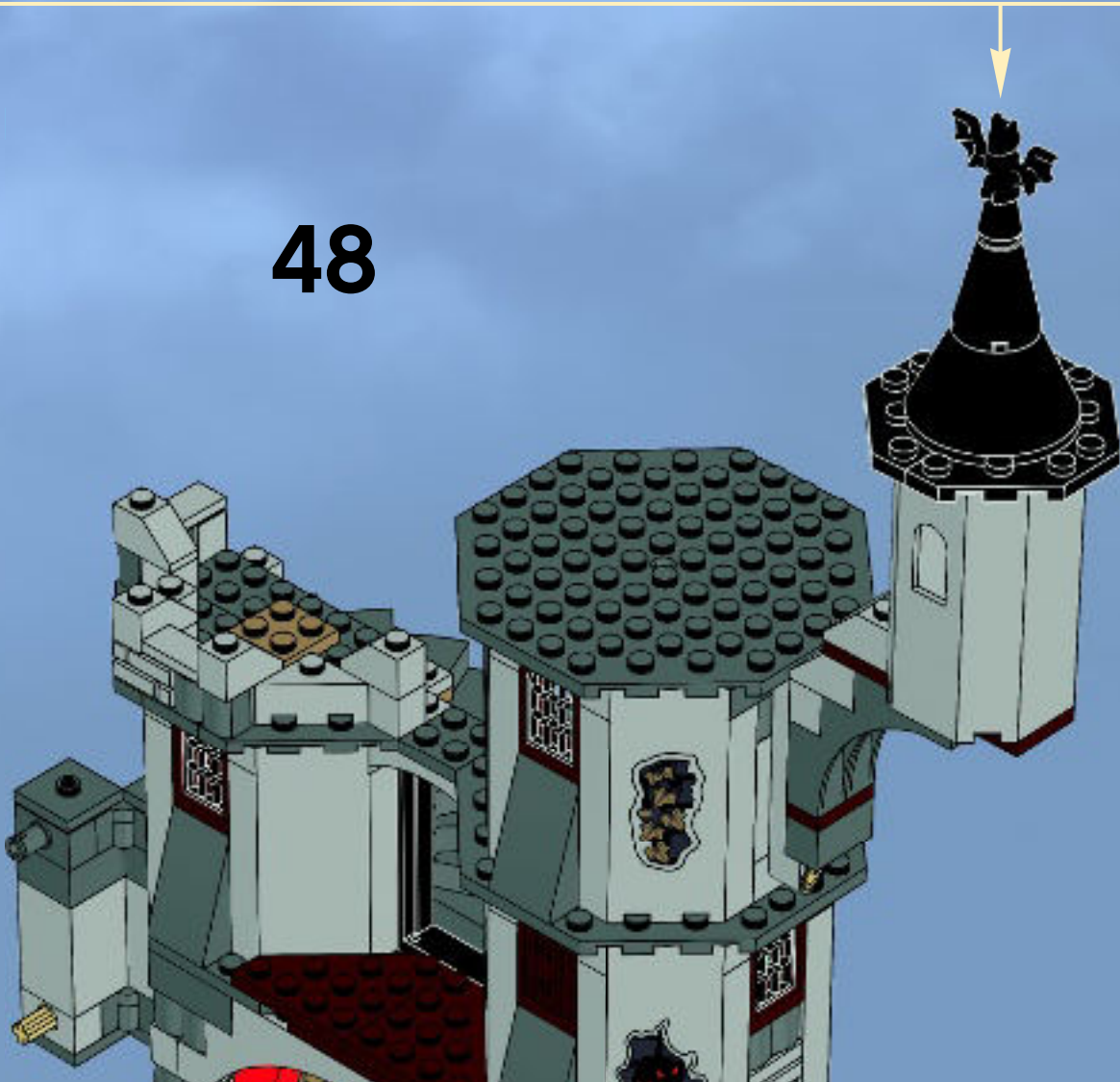

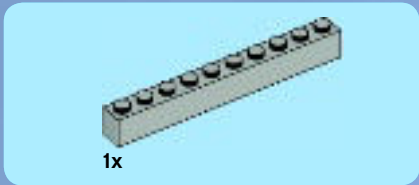

1x

1

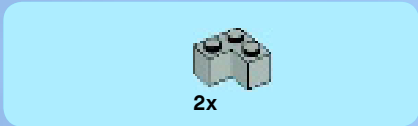
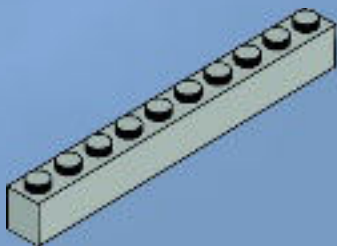

2x

2

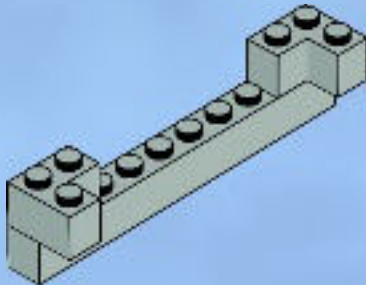

2x

3

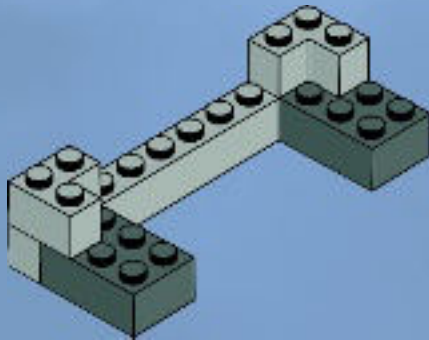



2x

4

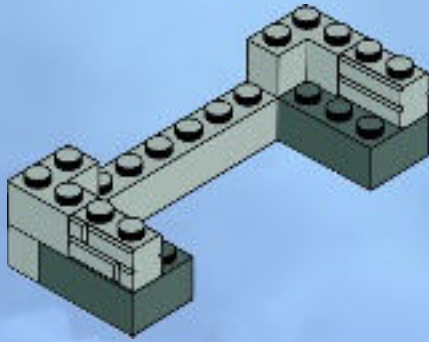

2x



2x

6

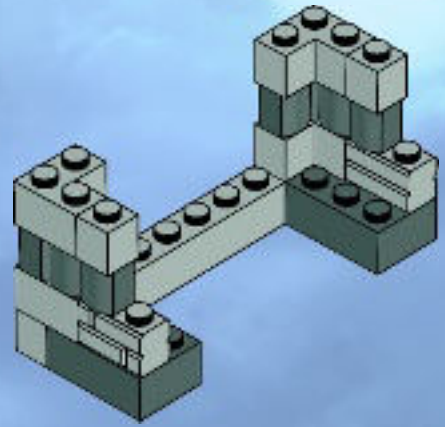

4x

5

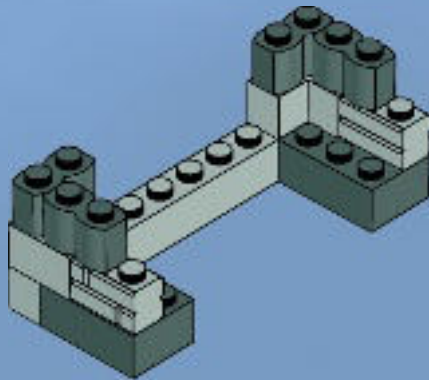

2x

7

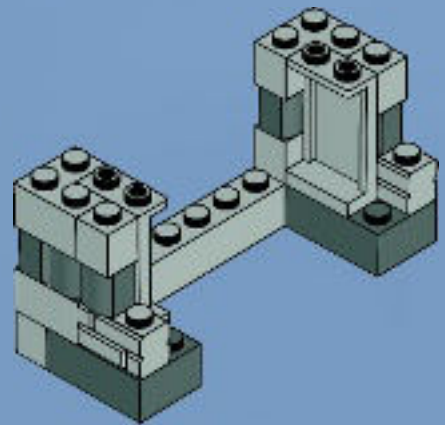



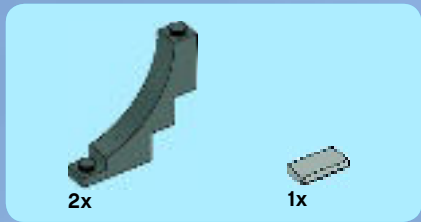

8

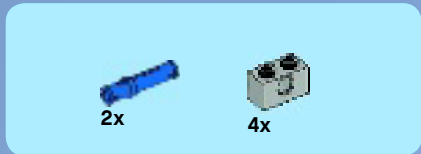
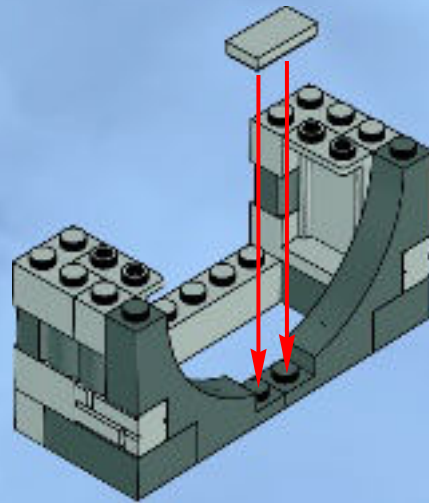

9

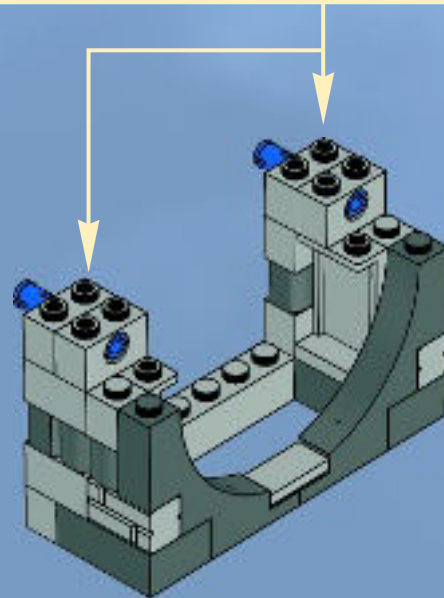
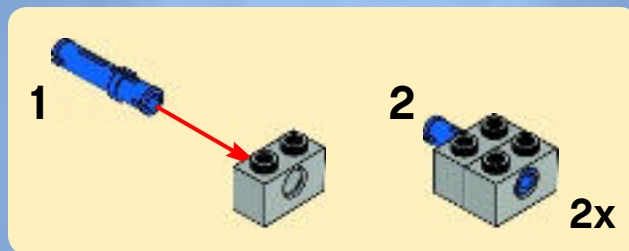



2x

# 10

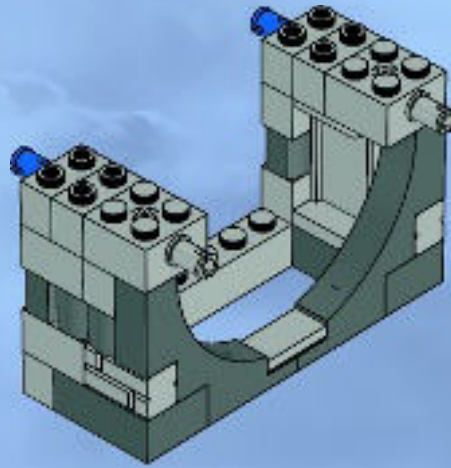

4x

# 11

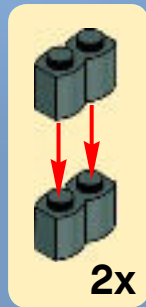

2x

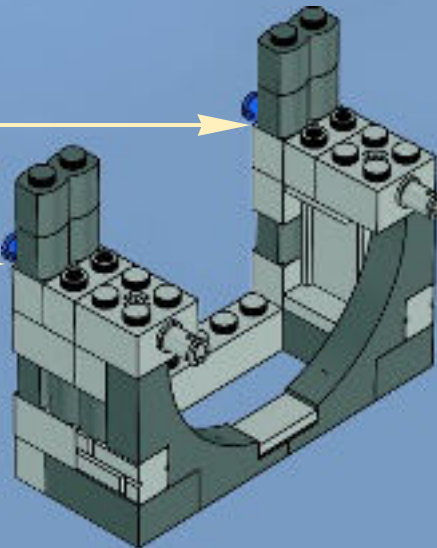

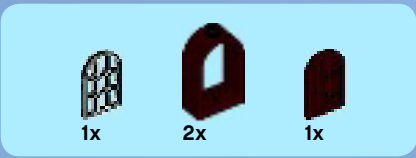

# 12

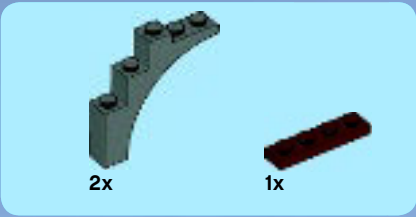
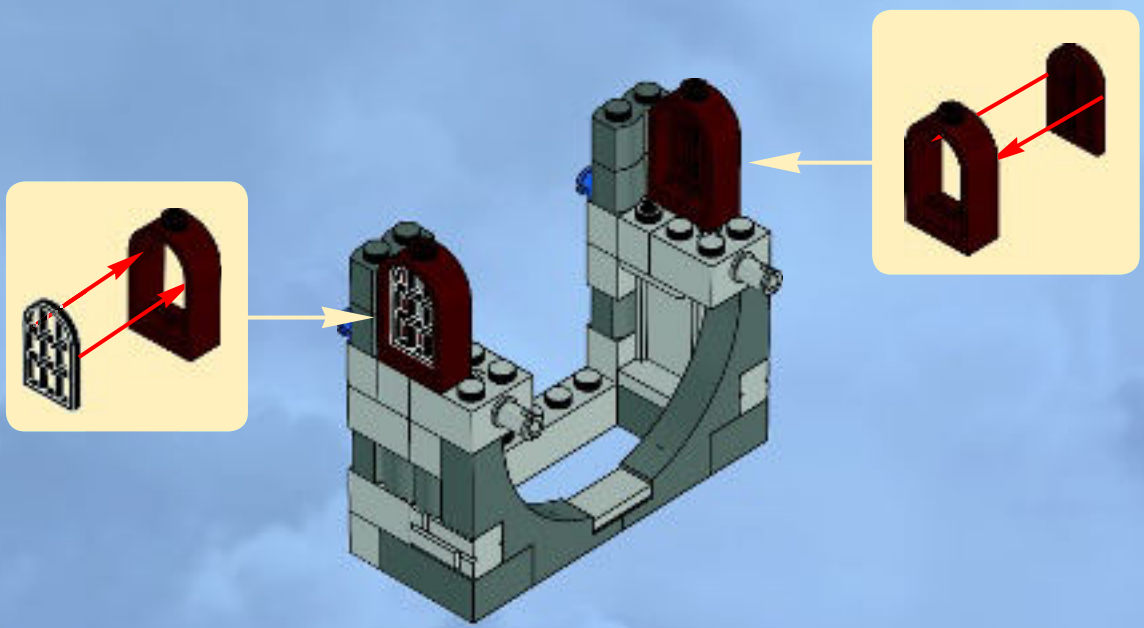

# 13

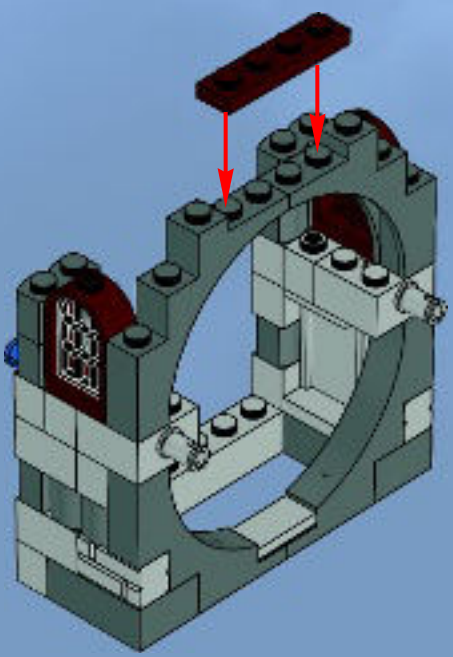





2x



2x

# 14

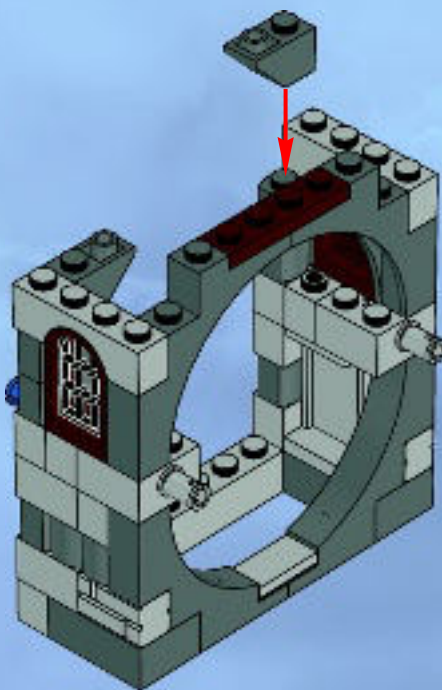

2x



1x

# 15

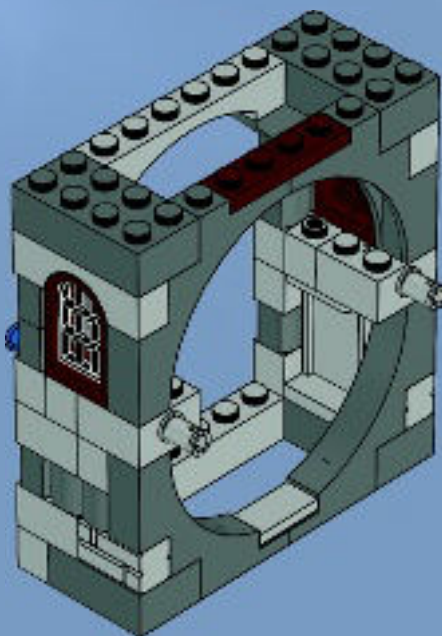



16

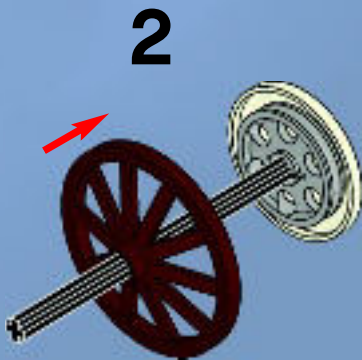
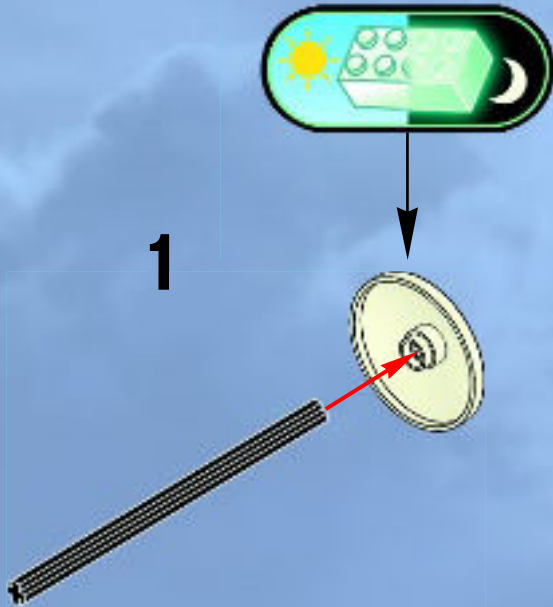

3

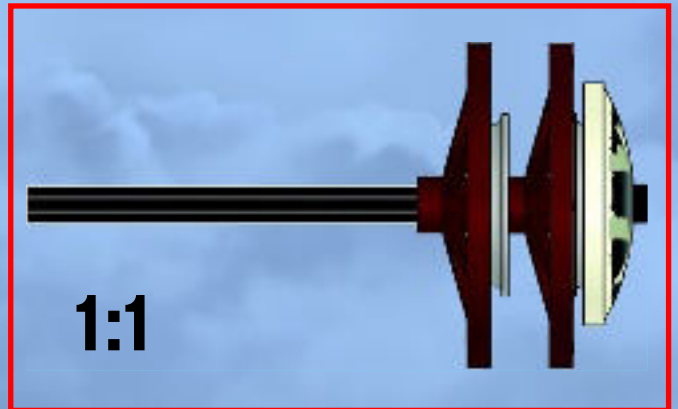
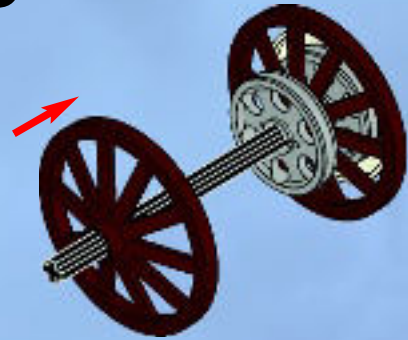

4

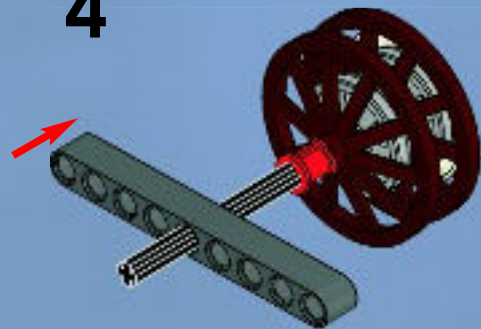

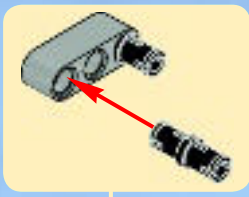

5

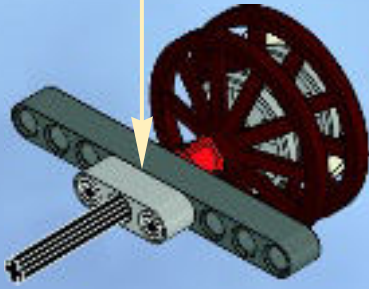

6

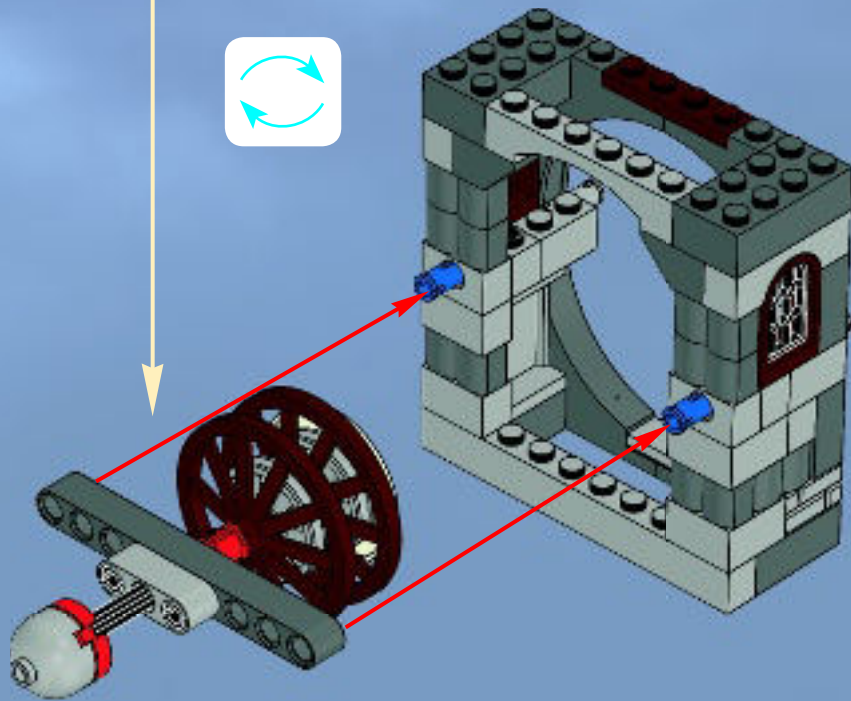
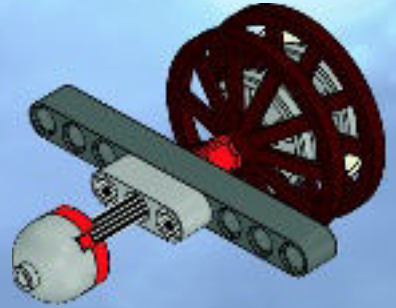





1



3



4



5



x2

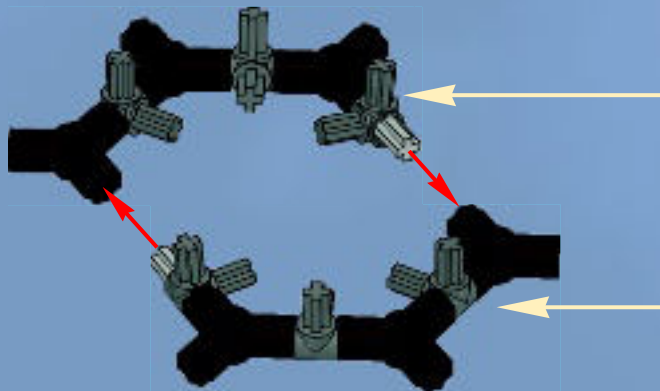



4x



4x

# 2



4x

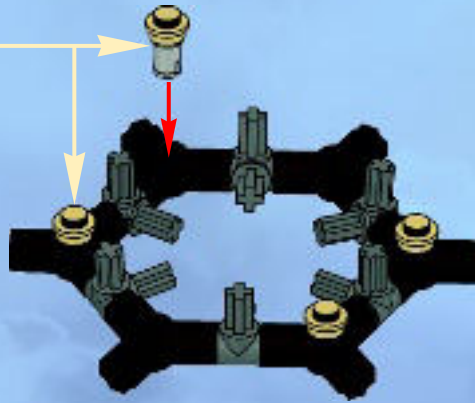

1x



1x



1x



1x



1x



1x

# 3



# 4

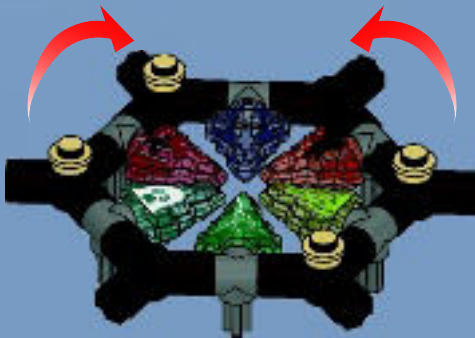

17

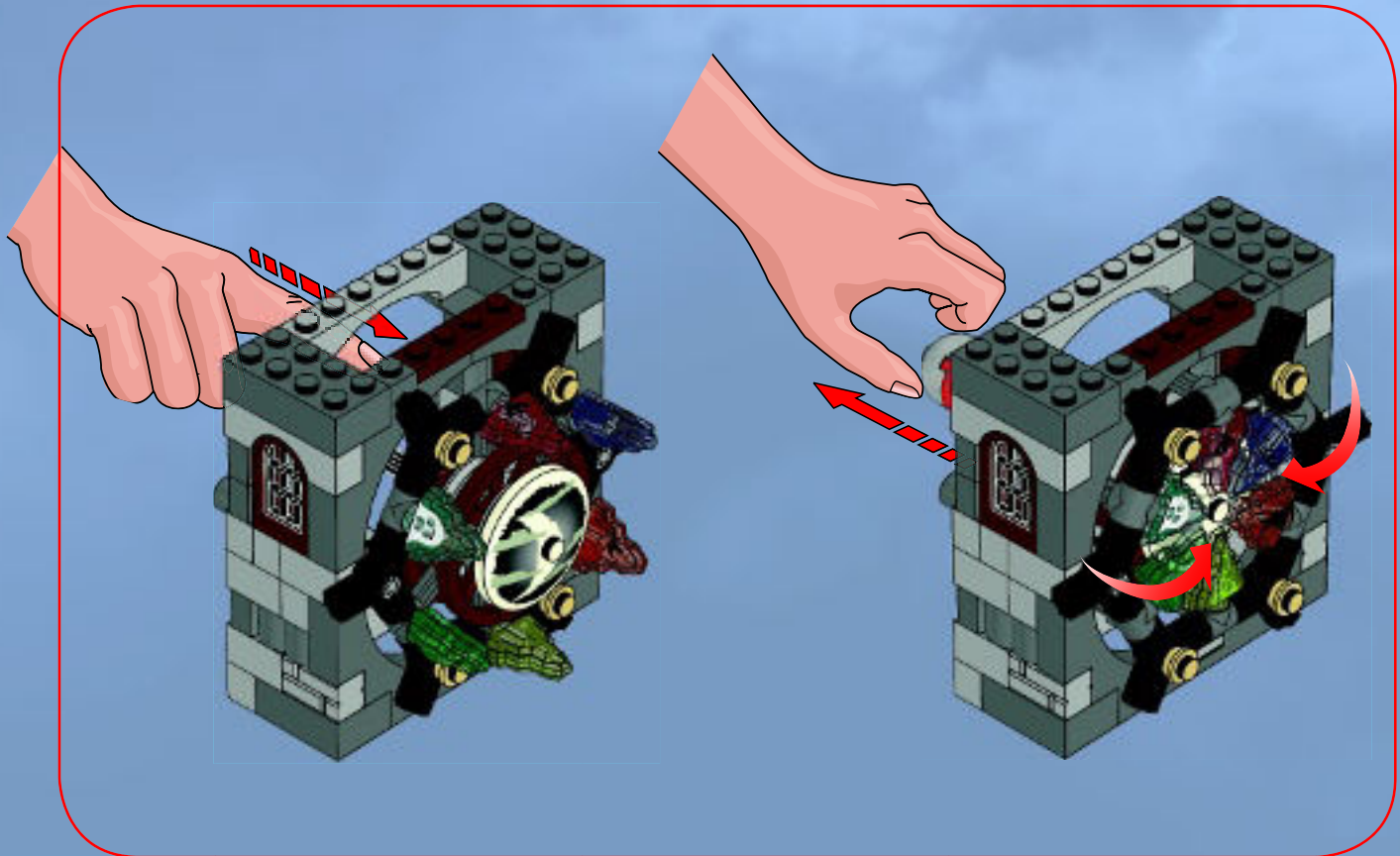
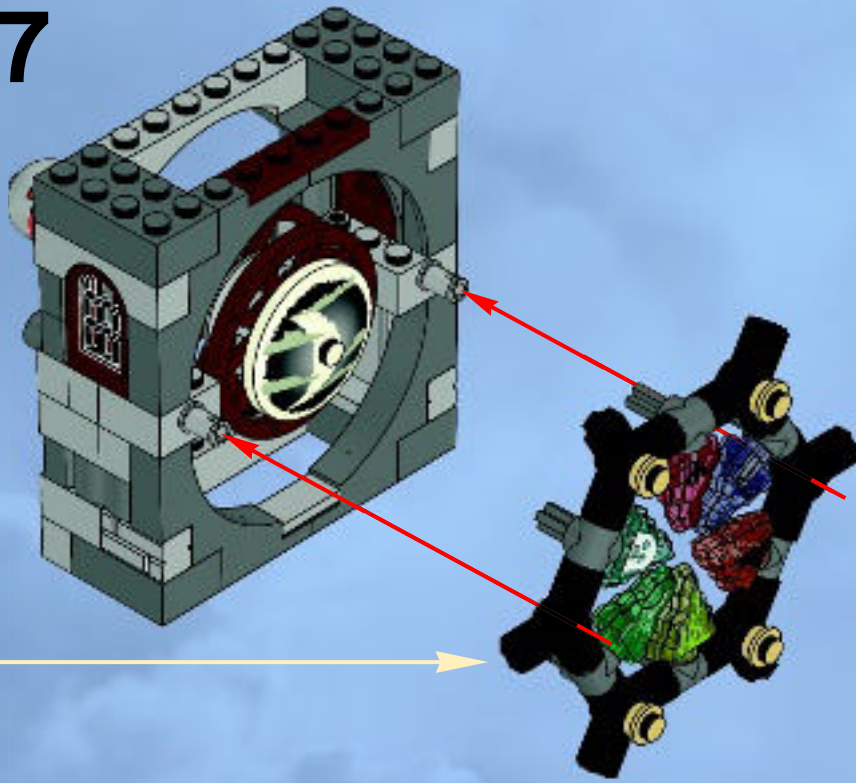



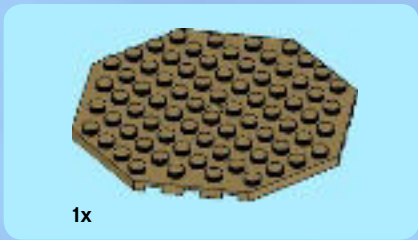

18

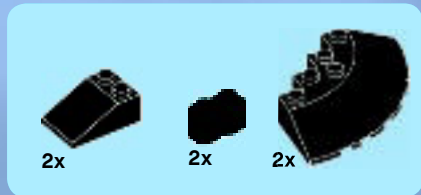
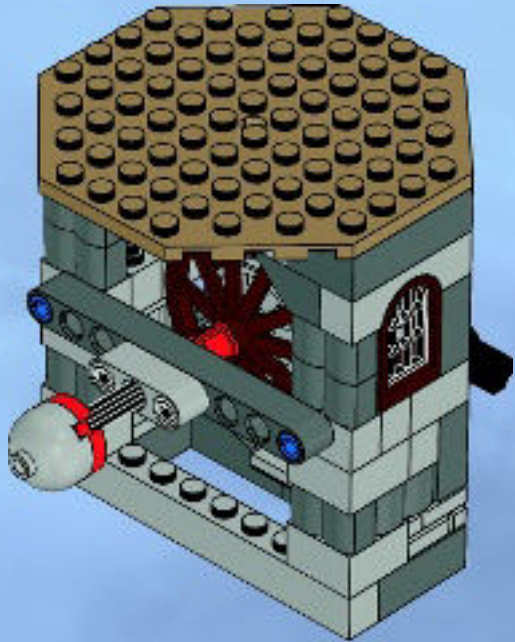

19

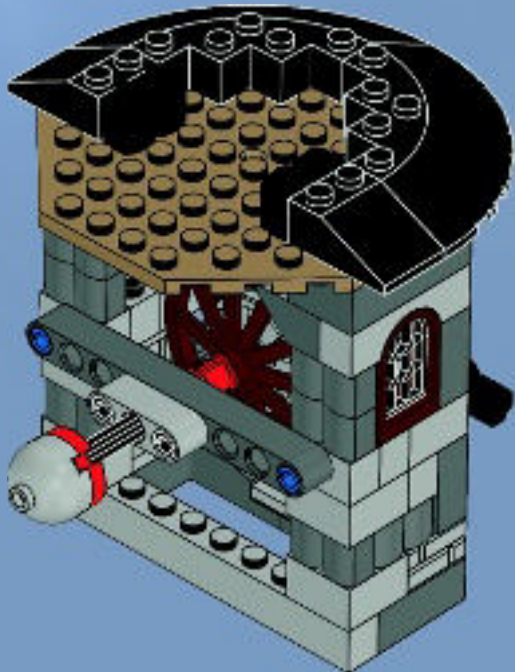

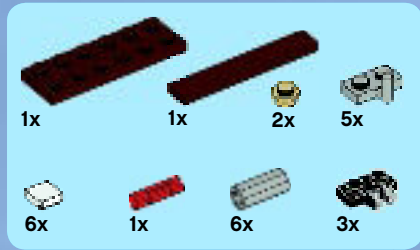

# 20

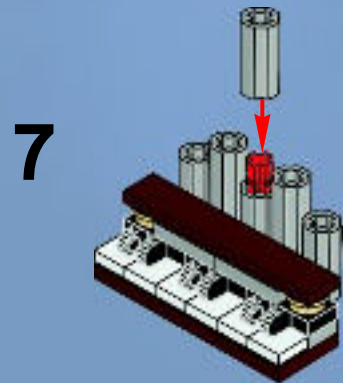
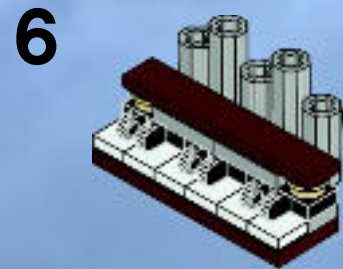
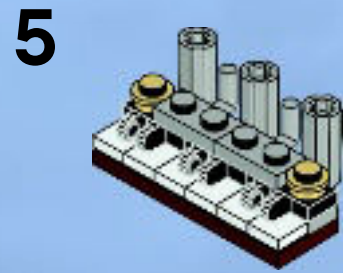
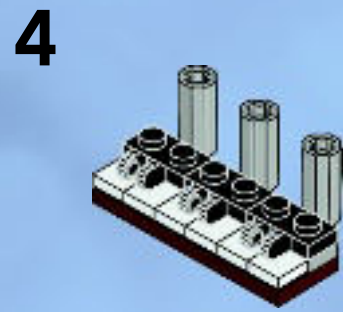
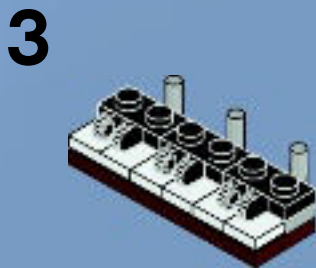
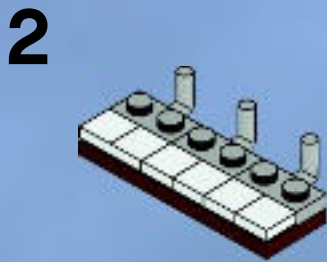
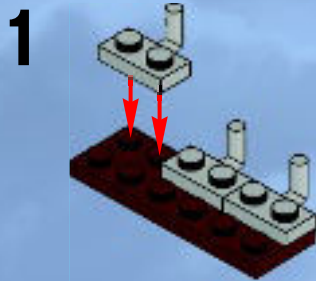

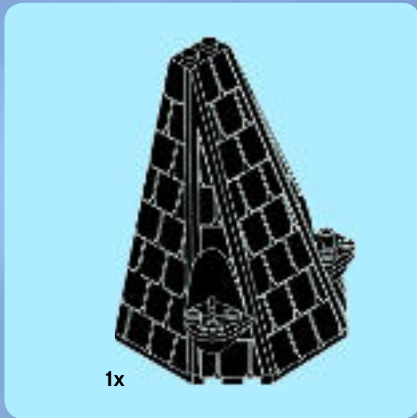
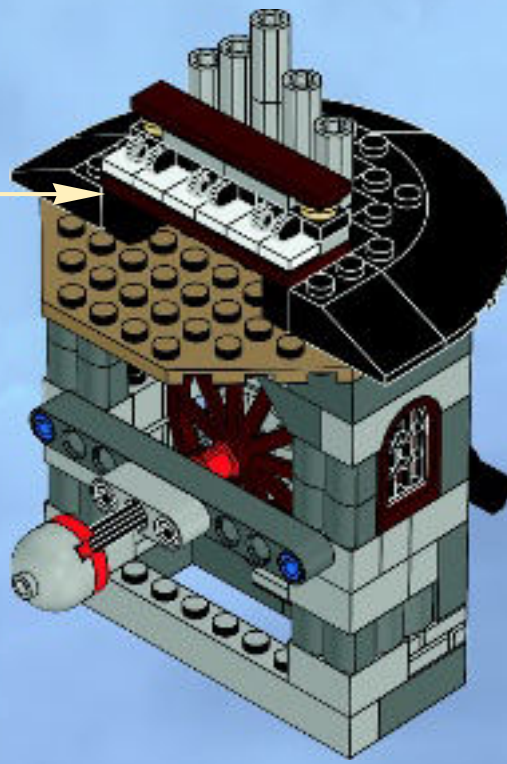

21

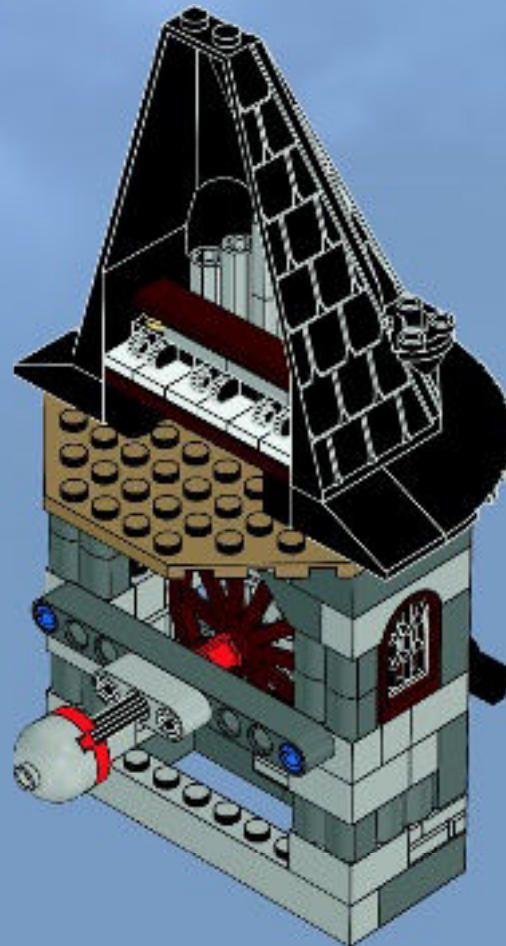

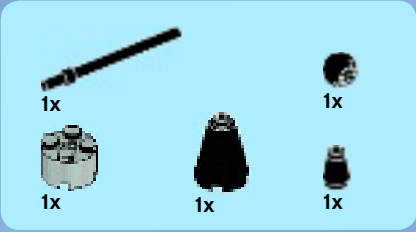

22

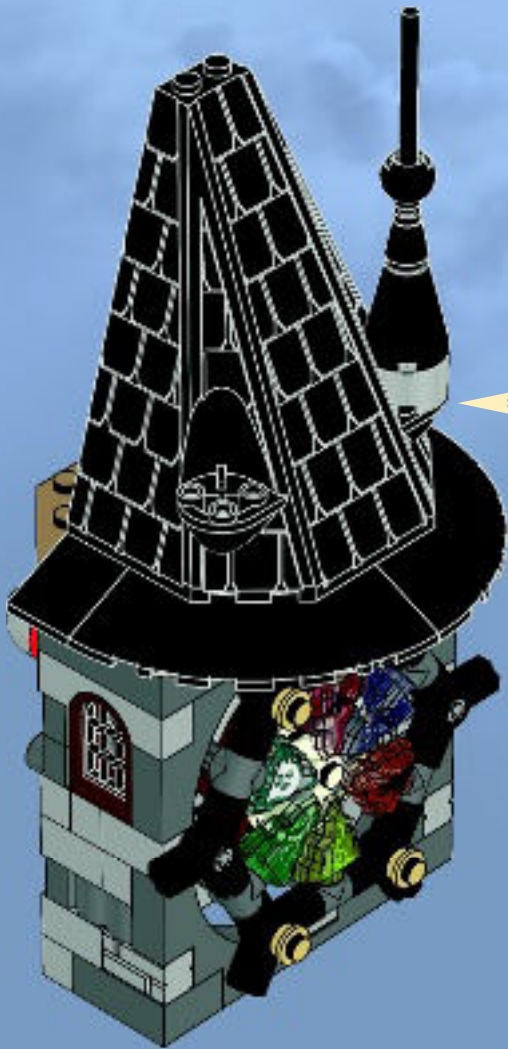
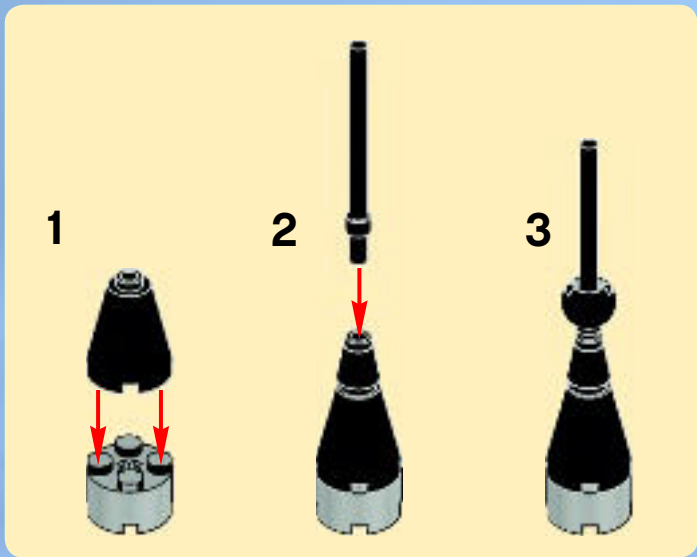





23

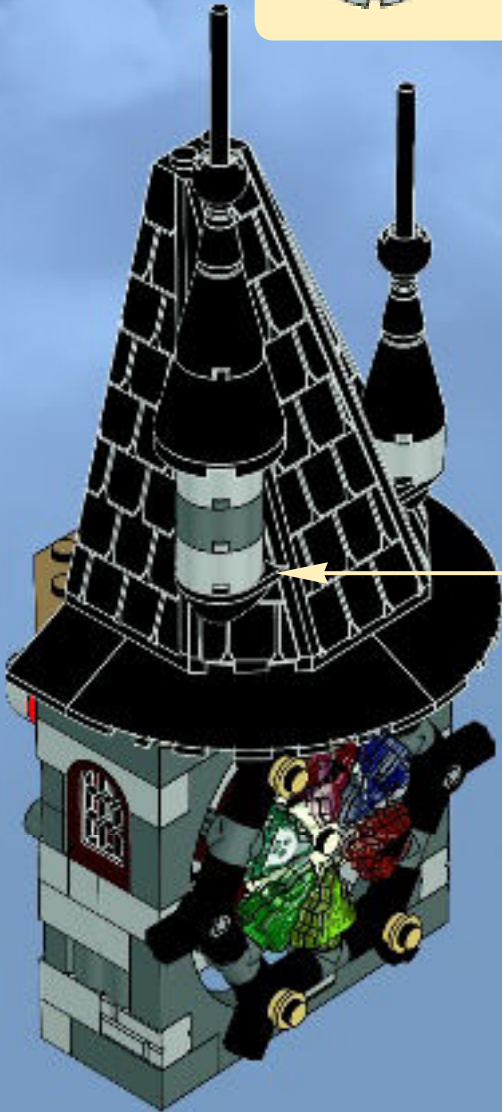
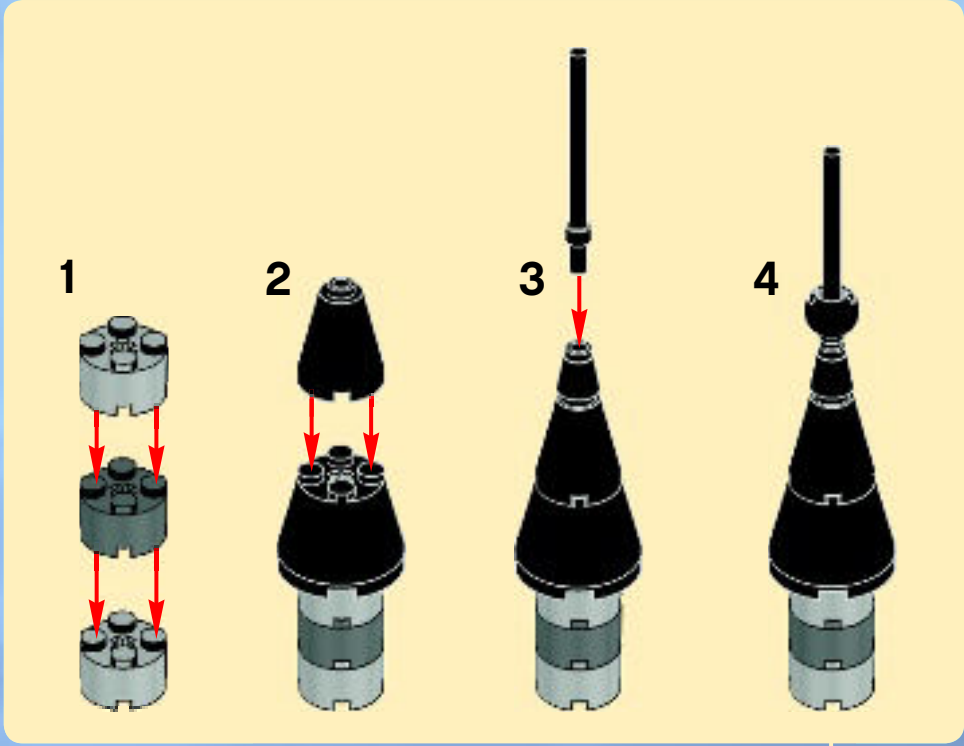



# 24

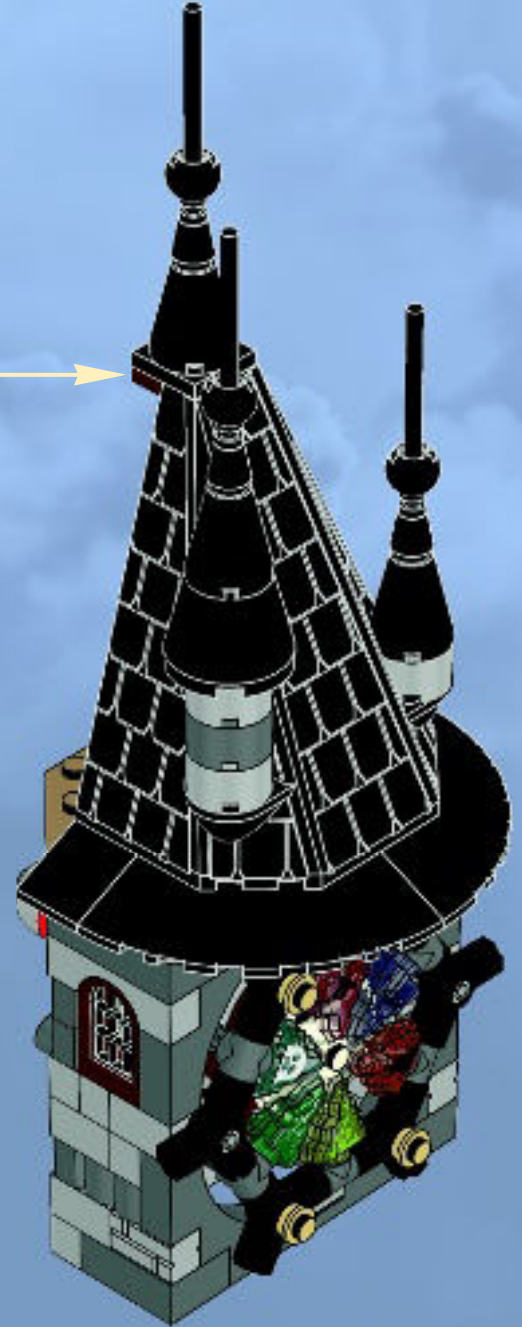
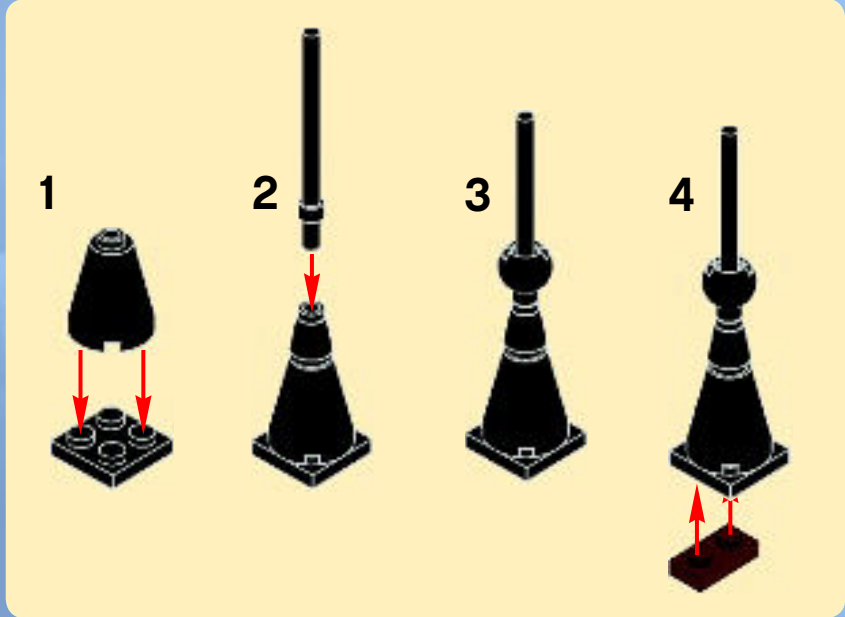













1x 4518400  
 2x 306201  
 1x 4547489  
 6x 307001  
 1x 4651445  
 2x 4142875  
 2x 626601  
 1x 626001  
 1x 4600294  
 16x 4568387  
 2x 4121921  
 2x 4114026  
 1x 4524449  
 37x 4161734  
 1x 4288363  
 3x 4666579  
 1x 4514554  
 2x 4501534  
 2x 4163087  
 2x 403221

1x 4598786  
 1x 613421  
 1x 4227155  
 7x 4142865  
 2x 6005935  
 4x 6005932  
 11x 4529236  
 9x 394226  
 4x 4500978  
 1x 4143243  
 8x 4286267  
 2x 4106513  
 4x 329826  
 2x 302226  
 2x 4550017  
 3x 4515340  
 2x 241926

10x 4105221  
 1x 4535834  
 1x 6008344  
 1x 6008340  
 1x 6005578  
 8x 4538722  
 1x 6006265  
 1x 4654943  
 1x 6006266  
 1x 4525078  
 1x 6005270  
 1x 4289538  
 4x 4639695  
 1x 73081  
 1x 4295395

4x 4121715  
 2x 4140430  
 1x 393726  
 1x 71155  
 2x 6008363  
 1x 4140801  
 2x 370326  
 1x 4107085  
 1x 373726  
 1x 4521947  
 6x 6008331  
 4x 6008334  
 1x 4655080  
 4x 4655077  
 4x 6008332  
 1x 4654448  
 8x 4584485

1x 4567331  
 1x 4119483  
 1x 4128576  
 1x 6006470  
 1x 4113955  
 1x 6005776  
 1x 4184851  
 1x 6005233  
 1x 6005238  
 1x 6006595  
 4x 4566927  
 1x 4528604  
 14x 4267874  
 1x 4541618  
 3x 4570451  
 1x 4594292

1x 4206482  
 3x 4514553  
 1x 4201201  
 1x 6006294  
 1x 600578  
 2x 4541528  
 1x 6008298  
 2x 4541060  
 2x 4539097  
 2x 4539105  
 2x 4539060  
 1x 6008291  
 2x 4222960  
 1x 4277016  
 1x 4223681  
 2x 6006576

1x 4626666  
 9x 4211150  
 12x 4211190  
 2x 4211247  
 1x 4271874  
 3x 4211288  
 1x 4224243  
 1x 4579690  
 1x 4211204  
 3x 4224732  
 7x 4624507  
 17x 4542131  
 1x 4211163  
 1x 4533101  
 1x 4211219  
 1x 4277751  
 1x 4262974

2x 4625993  
 1x 4252456  
 3x 4531751  
 4x 4244362  
 1x 4248937  
 1x 4618266  
 1x 3006841  
 2x 4201019  
 1x 4113954  
 1x 6006656  
 1x 6008325  
 4x 4529247  
 4x 4523159  
 1x 6012742  
 1x 6008010  
 1x 6006302  
 1x 6006154  
 1x 6005583





2x 4540865  
 1x 4157270  
 1x 4570877  
 2x 4211362  
 13x 4211389  
 2x 4211363  
 7x 4211650  
 5x 4211349  
 4x 4211428  
 2x 4211391  
 1x 4211521  
 2x 4535764  
 25x 6000066  
 2x 4211529  
 8x 6008364  
 9x 4585429

1x 4613165  
 8x 4211526  
 13x 4211718  
 24x 4211440  
 12x 4211614  
 4x 4568637  
 9x 4211410  
 15x 4211435  
 2x 4618874  
 1x 4224592  
 13x 4211353  
 2x 4211395  
 1x 4211404  
 3x 4211406  
 2x 4211369  
 13x 4211414  
 5x 4611702  
 1x 4211365  
 2x 42119256

1x 4520320  
 1x 4211655  
 2x 4211515  
 2x 4211637  
 1x 4610149  
 1x 6005319  
 24x 4563698  
 2x 4537056  
 6x 4211628  
 1x 6009885  
 1x 4653057  
 1x 6004729  
 1x 4641048  
 4x 4299119  
 1x 4259422  
 2x 4263192

1x 4495930  
 2x 4494222  
 10x 4211483  
 4x 4211807  
 6x 4512360  
 1x 4526985  
 6x 4211815  
 2x 4211566  
 1x 4211069  
 4x 4210631  
 12x 4211060  
 5x 4211105  
 2x 4211085  
 3x 4211100  
 62x 4211095  
 2x 4210935  
 11x 4211087  
 1x 4513326  
 4x 4249139  
 8x 4210639

2x 4213607  
 1x 4211137  
 1x 4516456  
 1x 4595708  
 2x 4210728  
 5x 4583688  
 1x 4296512  
 1x 4648067  
 1x 4595710  
 2x 4211008  
 1x 4645730  
 1x 4210997  
 2x 4211061  
 8x 4153418  
 1x 4210934  
 2x 4211051  
 2x 4567887

1x 4211029  
 2x 4623236  
 1x 4289542  
 2x 4210795  
 2x 6011461  
 4x 4221745  
 10x 6000853  
 2x 4211054  
 8x 4211000  
 2x 4246896  
 8x 6013256  
 2x 6005321  
 5x 4211094  
 9x 4565322  
 1x 6000177

2x 4210719  
 12x 4211096  
 2x 4210686  
 6x 4568734  
 6x 6005331  
 1x 4560177  
 1x 4508553  
 1x 6009159  
 1x 6008305  
 2x 6008244  
 6x 4519970  
 8x 4538950  
 2x 4529672  
 6x 6005755  
 2x 6006008  
 1x 4618270

  
**Customer Service**  
**Kundenservice**  
**Service Consommateurs**  
**Servicio Al Consumidor**  
[www.lego.com/service](http://www.lego.com/service) or dial  
 : 00800 5346 5555  
 : 1-800-422-5346





# MONSTER FIGHTERS



Use this code in the online game to unlock scary content. If you dare ...  
Schalte mit diesem Code den geheimen Inhalt frei. Traust du dich?  
Utilise ce code dans le jeu en ligne pour débloquer des contenus effrayants. Si tu oses ...  
Usa este código en el juego en línea para desbloquear una terrorífica sorpresa. Si te atreves ...  
Usa este código no jogo online para abrires um conteúdo assustador. Se tiveres coragem ...  
Ezzel a kóddal nyisd meg az online játékban az ijesztés témát. Ha mered ...



monsterfighters.LEGO.com





# MONSTER FIGHTERS



9461



9462



9463



9464



9466



9467



9468



LEGO

# MONSTER FIGHTERS

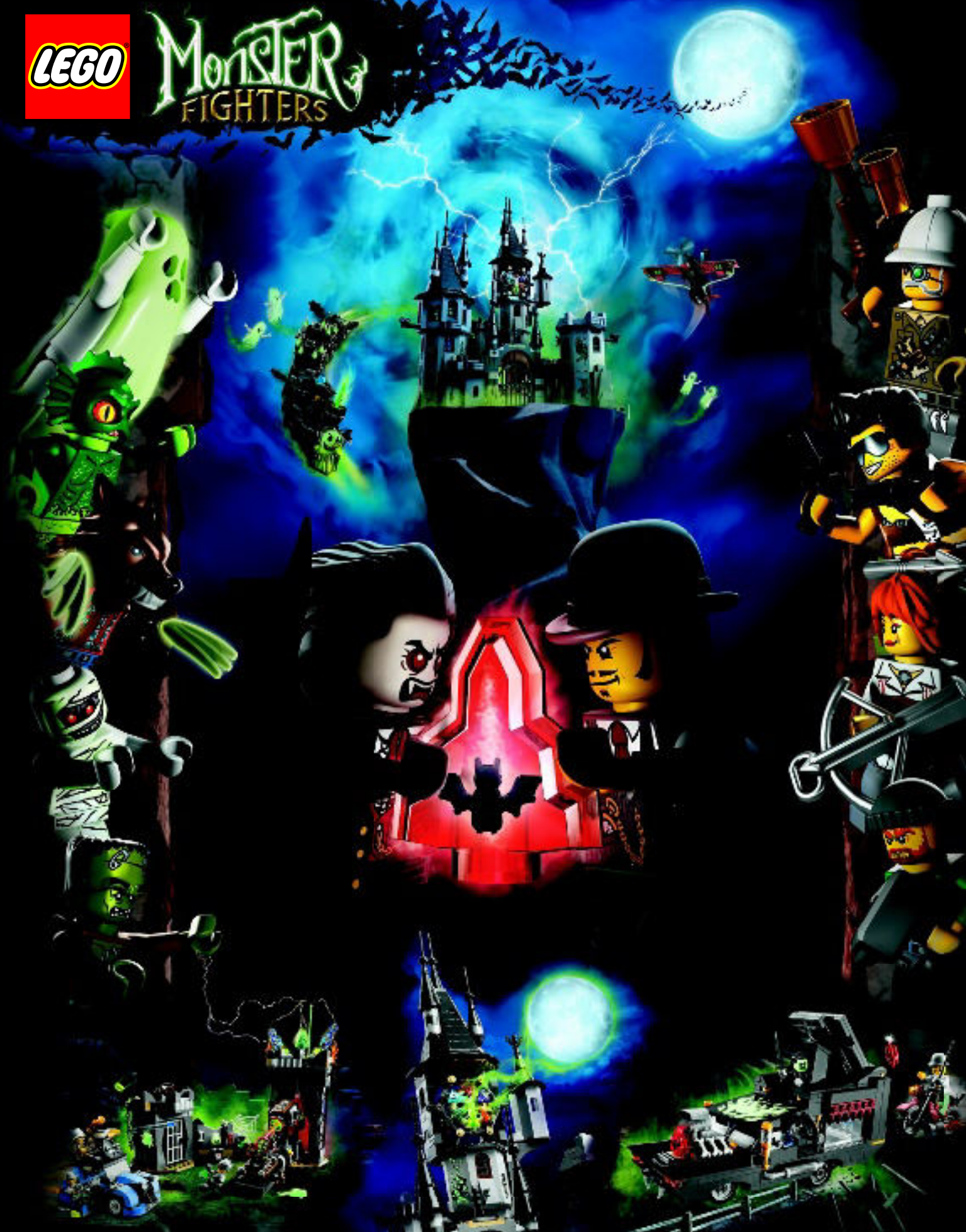



1



club™

FREE\*! GRATIS! GRATUIT!

www.LEGOclub.com/Max

2



3



\*Paid subscription in Australia and New Zealand.  
\*Abonnement payant en Australie et Nouvelle-Zélande.





# WIN!

Go to [www.LEGOsurvey.com/product](http://www.LEGOsurvey.com/product) to fill out a survey for a chance to win a cool LEGO® Product.

No purchase necessary.

Open to all residents where not prohibited.



[www.LEGO.com](http://www.LEGO.com)



## [www.LEGOsurvey.com/product](http://www.LEGOsurvey.com/product)

### GEWINNE!

Nimm an der Umfrage auf [www.LEGOsurvey.com/product](http://www.LEGOsurvey.com/product) teil und hab die Chance ein cooles LEGO® Produkt zu gewinnen!  
Die Teilnahme am Gewinnspiel führt zu keinerlei Kaufverpflichtungen. Teilnahme in allen nicht ausgeschlossenen Ländern möglich.

### WIN!

Ga naar [www.LEGOsurvey.com/product](http://www.LEGOsurvey.com/product), vul een enquêteformulier in en maak kans op een cool LEGO® product.  
Geen aankoopverplichting.  
Iedereen mag deelnemen, uitgezonderd ingezetenden van landen waar een enquêteverbod geldt.

### GAGNE!

Visite [www.LEGOsurvey.com/product](http://www.LEGOsurvey.com/product) pour répondre à un questionnaire et avoir une chance de gagner un produit LEGO® très cool!  
Aucune obligation d'achat.  
Ouvert à tous les résidents des pays autorisés.

### 当てよう!

[www.LEGOsurvey.com/product](http://www.LEGOsurvey.com/product) にアクセスして、アンケートにご記入ください。当選者にはレゴ®製品を差し上げます。  
お買い上げの必要はありません。  
禁止されていない限り、すべての皆様にご利用いただけます。